

Stonco KEENE

by  Signify

Wall Mount



LytePro Wall

LPW7

Small Wall Mount

LytePro Wall LPW7 Installation Instructions

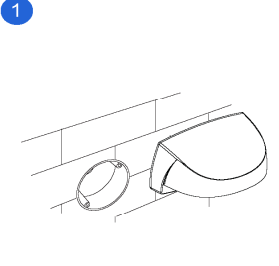
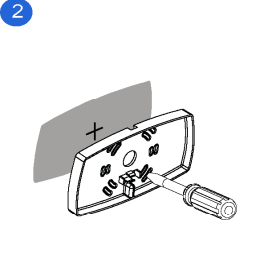

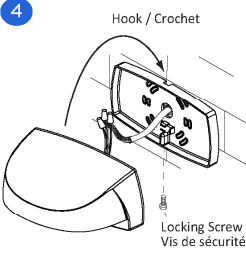
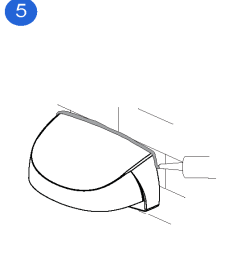
			 <p>Hook / Crochet</p> <p>Locking Screw Vis de sécurité</p>	
<p>1 Fixture can be mounted to 3-1/2" recessed and surface junction boxes, or directly to a surface without the use of a junction box. This fixture is approved for internal splicing.</p>	<p>2 Remove appropriate knockouts in mounting plate and gasket. Install adhesive gasket to back of mounting plate.</p>	<p>3 Install mounting plate to wall or junction box using hardware supplied by others.</p> <p>Use integrated bubble level to ensure plate is level.</p>	<p>4 Connect black wire to the 120v-277v supply lead. Connect white wire to the supply common lead. Connect supply ground lead.</p> <p>Hook fixture onto mounting plate & ensure wires are not being pinched between housing & mounting plate. Secure with supplied screw.</p>	<p>5 Place a bead of caulk on the top and side edge of fixture between the housing and wall.</p> <div data-bbox="1315 1123 1502 1260" style="border: 1px solid black; padding: 5px;"> <p>⚡ WARNING: ⚡ Never attempt to adjust or service unit with power on. Make sure fixture is cool before servicing.</p> </div>

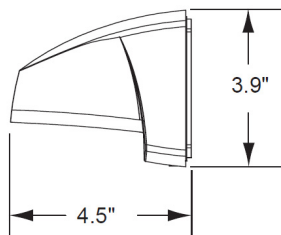
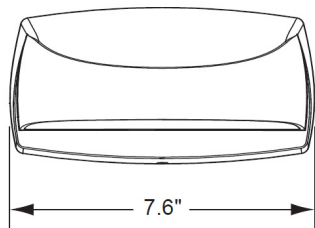

Dimension - Overall Fixture

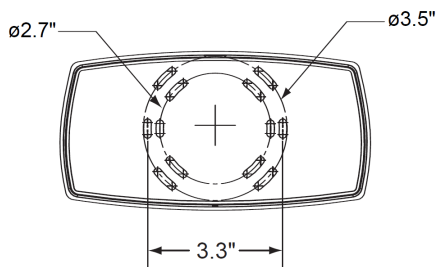

Dimension - Mounting Plate Knockouts

Troubleshooting Guide

Symptoms	Possible Cause(s)	Corrective Action
No Light	1. No power to unit. 2. Loose wiring	1. Check circuit protection device (circuit breaker, fuse or switch). 2. Recheck wiring connections (with power off)

NOTICE: DO NOT MOUNT LYTEPRO SOLELY TO THIS COVER PLATE. IT IS NOT INTENDED TO SUPPORT THE WEIGHT OF THE LUMINAIRE.

REMOVE OLD LUMINAIRE; LEAVING J-BOX EXPOSED.

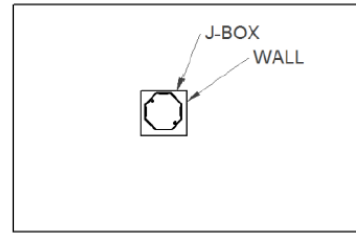

RUN A BEAD OF SILICONE ON BACK SIDE OF COVER PLATE, ALONG TOP AND SIDES TO SEAL SPLICE BOX. ALIGN AND LEVEL COVER PLATE WITH J-BOX MOUNTING HOLES.

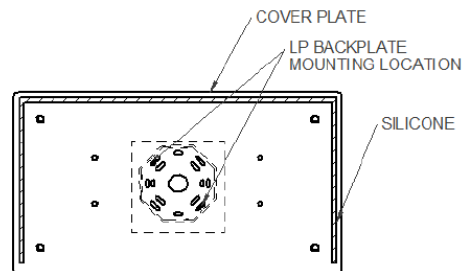

ATTACH PLATE TO WALL USING EITHER SET OF (QTY4) MOUNTING HOLES. PUNCH OUT TABS TO ALLOW LAG BOLTS TO PASS THROUGH. (HARDWARE PROVIDED BY OTHERS)

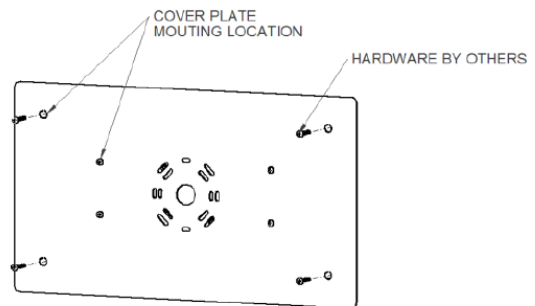

MOUNT LYTEPRO SCENCE ACCORDING TO INSTALLATION INSTRUCTIONS INCLUDED WITH LUMINAIRE.

