

Specifically designed to blend high performance LED technology with versatile options to suit any area, **VersaForm** allows you to enjoy the latest LED energy efficiencies in concert with your unique style, and as your needs evolve, it's simple to change or upgrade with our unique detachable light engine.

**This product family is to be discontinued. Please consult factory for details.**

Project:	
Location:	
Cat.No:	
Type:	
Line ID:	Qty:
Notes:	

### Ordering guide

example: 4122D1STL8BDS1DE

Family	Size	Version	Configuration	Source	CRI/CCT <sup>1</sup>	Lumens <sup>1</sup>	Housing	Wiring <sup>2,4</sup>	Voltage <sup>2</sup>	Driver <sup>2</sup>	Option <sup>3</sup>
<b>41</b>			<b>ST</b>	<b>L</b>							
<b>41</b> VersaForm	<b>22</b> 2'x2'	<b>D1</b> Standard T-Grid <b>D2</b> Slot T-Gird <b>S1</b> Discrete Surface Mount	<b>ST</b> Standalone	<b>L</b> LED	<b>8A</b> 90CRI/4000K	<b>D</b> 4000lm	<b>S</b> Standard <b>C</b> Chicago Plenum	<b>1</b> 1cct Dimming <b>B</b> 1cct Dimming + Battery Pack	<b>D</b> UNV 120-277V <b>3</b> 347V	<b>E</b> Advance 0-10V (1% Dim) <b>H</b> Lutron EcoSystem LDE1	<b>P</b> Flex Whip (6') <b>D</b> Drywall Trim Kit
					<b>8B</b> 90CRI/3500K	<b>E</b> 3000lm					
					<b>8C</b> 90CRI/3000K	<b>A</b> 6800lm					
	<b>24</b> 2'x4'					<b>C</b> 5200lm <b>D</b> 4000lm					

- Nominal values within a range. Consult photometry data for CRI, color temp, lumens & distribution of chosen configuration.
- Not all wiring types are available with all configurations. Consult Ledalite for a complete list of available options.
- Drywall Kits and Flex Whips are not available with "SI" Discrete Surface Mount luminaires.
- Legacy coding for wiring options "7 - 1cct dimming" and "N - 1cct Dimming + Battery Pack" are exact equals to "1" and "B" options shown in the ordering guide.

If no option is required, leave blank.

2'x2'

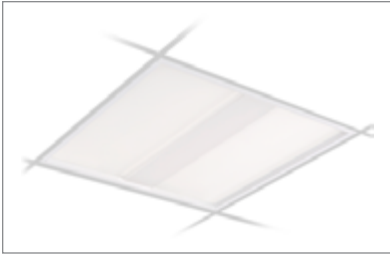

Cross Section View

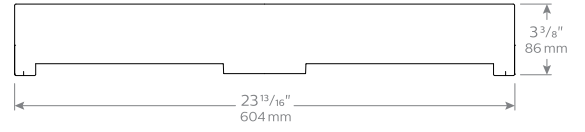

Housing

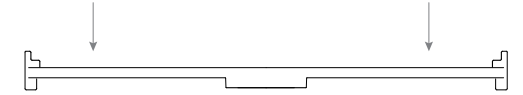
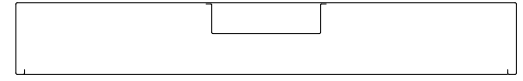

Light Engine

2'x4'



Cross Section View

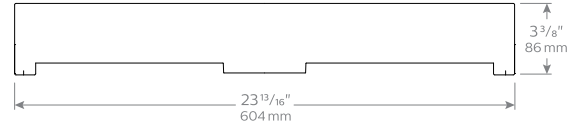

Housing

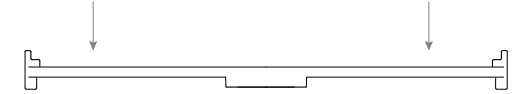
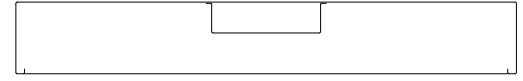

Light Engine

# VersaForm recessed & surface

## 2'x2' & 2'x4'

### Specifications

#### Optical System

The optical frame assembly consists of integrated LED arrays edge lighting a light guide panel in order to deliver uniform controlled light through a lower lens. The optical frame ends are constructed from die-formed cold-rolled steel, assembled together with extruded aluminum profiles in a sturdy frame. The frame is hinged (side marked) to allow easy access to the inside of the fixture. Maintenance can be performed from below the ceiling.

#### Finish

Housing and frame painted, high quality, powder coated matte white only.

#### Housing

Die-formed, post painted, 22 gauge cold-rolled steel. Wire entrance with additional knock-out available on top side for electrical connections.

#### Weight

Maximum 28lbs (2x4); 15lbs (2x2).

#### Electrical

Factory pre-wired with driver safety disconnect.

#### Mounting

Recessed: Fixtures can be fastened directly to the T-bar grid and/or tied-off to the building structure. Optional drywall kit trim mount can be fastened to a wood frame or with hangar wire. Continuous row mounting not available with drywall kit trim mounts.

Surface: Fixtures can be mounted over recessed junction box and side entry also available.

#### Standard Driver

- Advance Xitanium 0-10V, 1-100%
- Lutron EcoSystem LDE1 with Soft-on, Fade-to-Black, 1-100%

Class 2 rated output.

Consult Ledalite for other available drivers.

#### Standard Battery Pack

Bodine, 90 min, 10W, Class 2 rated output, Battery Pack lumen output = 10W x luminaire efficacy x 1.1. Typical output: 1200lm.

#### Lumen Maintenance

LEDs have been tested by the manufacturer in accordance with IESNA LM-80-08. At an ambient temperature of 25°C, the LED lumen maintenance expectation according to IES TM-21-11 is: L90(10K) >60,000 hrs (reported methodology). L80(10K) 128,000 hrs (calculated methodology).

#### Source Color

LEDs rated for color rendering CRI >90, R9 >50 and fixture to fixture color accuracy within 3 SDCM.

#### QuickShip

Available for certain configurations upon request. Visit [www.signify.com/en-us/brands/ledalite/quickship](http://www.signify.com/en-us/brands/ledalite/quickship) for more information

#### Wiring

Recessed: Optional flex whips are supplied in 6' lengths.

Surface: Standard wiring configurations available.

#### Approvals

Certified to UL, CSA, and IES standards. City of Chicago Approved CCEA (housing option C).

#### Warranty

Five-year luminaire limited warranty including LED boards and driver. See [www.signify.com/warranties](http://www.signify.com/warranties) for details.

#### Environment

Rated for dry & damp locations in operating ambient temperatures of 0-25°C (32-77°F). Many luminaire components, such as reflectors, refractors, lenses, and LEDs are made from various types of plastics which can be adversely affected by airborne contaminants. If sulfur based chemicals, petroleum based products, cleaning solutions, or other contaminants are expected in the intended area of use, consult factory for compatibility. Damage caused by sulfur, chlorine, petroleum based solution or other contaminants are not covered under warranty.

# VersaForm recessed & surface

## 2'x2' & 2'x4'

### Photometrics

2'x2'

Spacing Criteria: 1.32/1.57

(Click "PDF" and "IES" text to Download)

Lumen Package	Nominal CRI & CCT	Flux (lm)	Watts (W)	Efficacy (LPW)	CRI	R9	DLC	Photometry Report	IES File
4000lm	90CRI, 4000K	3926	33.6	116.8	90+	50+	N/A	<a href="#">PDF</a>	<a href="#">IES</a>
	90CRI, 3500K	3871	33.5	115.6	90+	50+	N/A	<a href="#">PDF</a>	<a href="#">IES</a>
	90CRI, 3000K	3720	33.4	111.4	90+	50+	N/A	<a href="#">PDF</a>	<a href="#">IES</a>
3000lm	90CRI, 4000K	3102	25.8	120.2	90+	50+	N/A	<a href="#">PDF</a>	<a href="#">IES</a>
	90CRI, 3500K	3058	25.8	118.5	90+	50+	N/A	<a href="#">PDF</a>	<a href="#">IES</a>
	90CRI, 3000K	2940	25.8	114.0	90+	50+	N/A	<a href="#">PDF</a>	<a href="#">IES</a>

CANDELA DISTRIBUTION						Flux
	0	22.5	45	67.5	90	Lumens
0	916	916	916	916	916	-
5	913	916	918	920	922	88
15	897	905	921	937	947	261
25	856	874	912	954	974	422
35	775	811	865	937	960	544
45	653	698	748	836	861	585
55	489	529	569	660	673	522
65	321	347	370	422	441	377
75	155	181	183	221	224	205
85	39	45	41	62	55	55
90	0	0	0	0	0	-
95	0	0	0	0	0	0
105	0	0	0	0	0	0
115	0	0	0	0	0	0
125	0	0	0	0	0	0
135	0	0	0	0	0	0
145	0	0	0	0	0	0
155	0	0	0	0	0	0
165	0	0	0	0	0	0
175	0	0	0	0	0	0
180	0	0	0	0	0	-

COEFFICIENTS OF UTILIZATION (%)												
Pc---	80				70			50			0	
Pw---	70	50	30	10	70	50	30	50	30	10	0	
RCR												
0	119	119	119	119	116	116	116	111	111	111	100	
1	109	104	100	96	106	102	98	97	94	91	84	
2	99	90	83	78	96	88	82	85	79	75	69	
3	90	79	71	64	87	77	70	74	68	62	58	
4	82	70	61	54	80	68	60	66	59	53	49	
5	75	62	53	46	73	61	52	59	51	45	42	
6	69	56	47	40	67	55	46	53	45	40	37	
7	64	50	41	35	62	50	41	48	40	35	32	
8	60	46	37	31	58	45	37	44	36	31	29	
9	56	42	34	28	54	41	33	40	33	28	26	
10	52	39	31	25	51	38	30	37	30	25	23	

AVG LUMINANCE (cd/m <sup>2</sup> )			
	0	45	90
0	2976	2976	2976
5	2977	2994	3005
15	3015	3097	3183
25	3068	3268	3489
35	3075	3430	3805
45	2997	3438	3957
55	2772	3225	3812
65	2470	2841	3389
75	1942	2300	2815
85	1434	1522	2052

ZONAL LUMEN SUMMARY			
Zone	Lumens	%Fixture	%Lamp
0-30	771	25.2%	25.2%
0-40	1315	43.0%	43.0%
0-60	2421	79.2%	79.2%
0-90	3058	100.0%	100.0%
90-130	0	0.0%	0.0%
90-150	0	0.0%	0.0%
90-180	0	0.0%	0.0%
0-180	3058	100.0%	100.0%

Electrical	Watts	Amps	THD%	PF
120V	25.8	0.218	10.5	0.990
277V	25.9	0.101	16.6	0.930
347V	25.8	0.078	9.9	0.947

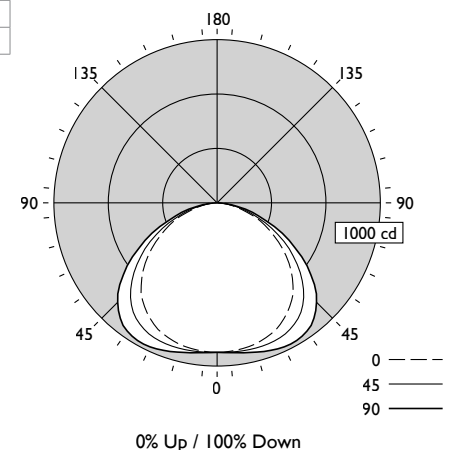

\*Photometric data shown is for 3000lm, 3500K, 90 CRI configuration.

# VersaForm recessed & surface

## 2'x2' & 2'x4'

### Photometrics

2'x4'

Spacing Criteria: 1.33/1.53

(Click "PDF" and "IES" text to Download)

Lumen Package	Nominal CRI & CCT	Flux (lm)	Watts (W)	Efficacy (LPW)	CRI	R9	DLC	Photometry Report	IES File
6800lm	90CRI, 4000K	7134	57.2	124.7	90+	50+	N/A	<a href="#">PDF</a>	<a href="#">IES</a>
	90CRI, 3500K	6964	57.3	121.5	90+	50+	N/A	<a href="#">PDF</a>	<a href="#">IES</a>
	90CRI, 3000K	6805	58.0	117.3	90+	50+	N/A	<a href="#">PDF</a>	<a href="#">IES</a>
5200lm	90CRI, 4000K	5479	43.3	126.5	90+	50+	N/A	<a href="#">PDF</a>	<a href="#">IES</a>
	90CRI, 3500K	5349	43.3	123.5	90+	50+	N/A	<a href="#">PDF</a>	<a href="#">IES</a>
	90CRI, 3000K	5228	43.3	120.7	90+	50+	N/A	<a href="#">PDF</a>	<a href="#">IES</a>
4000lm	90CRI, 4000K	4131	32.1	128.7	90+	50+	N/A	<a href="#">PDF</a>	<a href="#">IES</a>
	90CRI, 3500K	4032	32.1	125.6	90+	50+	N/A	<a href="#">PDF</a>	<a href="#">IES</a>
	90CRI, 3000K	3942	32.1	122.8	90+	50+	N/A	<a href="#">PDF</a>	<a href="#">IES</a>

CANDELA DISTRIBUTION						Flux
	0	22.5	45	67.5	90	Lumens
0	1236	1236	1236	1236	1236	-
5	1233	1235	1238	1241	1242	118
15	1211	1223	1240	1261	1271	352
25	1160	1181	1223	1273	1292	566
35	1057	1093	1148	1230	1254	723
45	895	934	988	1093	1108	772
55	675	704	743	842	842	681
65	436	464	476	546	544	490
75	218	231	237	282	270	263
85	50	59	51	71	65	69
90	0	0	0	0	0	-
95	0	0	0	0	0	0
105	0	0	0	0	0	0
115	0	0	0	0	0	0
125	0	0	0	0	0	0
135	0	0	0	0	0	0
145	0	0	0	0	0	0
155	0	0	0	0	0	0
165	0	0	0	0	0	0
175	0	0	0	0	0	0
180	0	0	0	0	0	-

\*Photometric data shown is for 4000lm, 3500K, 90 CRI configuration.

COEFFICIENTS OF UTILIZATION (%)													
Pc---	80				70				50				0
Pw---	70	50	30	10	70	50	30	50	30	10	0	0	
RCR													
0	119	119	119	119	116	116	116	111	111	111	100		
1	109	104	100	96	106	102	98	97	94	91	84		
2	99	91	84	78	96	89	82	85	80	75	70		
3	90	79	71	65	87	78	70	75	68	63	58		
4	82	70	61	54	80	69	60	66	59	53	50		
5	75	62	53	47	73	61	53	59	52	46	43		
6	70	56	47	40	68	55	47	53	46	40	37		
7	64	51	42	36	63	50	41	48	41	35	33		
8	60	46	38	32	58	45	37	44	37	31	29		
9	56	42	34	28	54	42	34	40	33	28	26		
10	52	39	31	26	51	38	31	37	30	25	23		

ZONAL LUMEN SUMMARY			
Zone	Lumens	%Fixture	%Lamp
0-30	1035	25.7%	25.7%
0-40	1758	43.6%	43.6%
0-60	3211	79.6%	79.6%
0-90	4032	100.0%	100.0%
90-130	0	0.0%	0.0%
90-150	0	0.0%	0.0%
90-180	0	0.0%	0.0%
0-180	4032	100.0%	100.0%

Electrical	Watts	Amps	THD%	PF
120V	32.1	0.270	7.4	0.990
277V	32.1	0.120	9.2	0.960
347V	31.8	0.095	8.2	0.960

AVG LUMINANCE (cd/m²)			
	0	45	90
0	1912	1912	1912
5	1915	1924	1929
15	1940	1988	2036
25	1980	2088	2206
35	1997	2169	2369
45	1959	2163	2425
55	1822	2004	2273
65	1598	1744	1992
75	1302	1420	1613
85	893	907	1157

