



INSTALLATION

WARNINGS AND INSTRUCTIONS FOR LUMINAIRES

IMPORTANT: FOR YOUR PROTECTION, YOU MUST CAREFULLY READ ALL WARNINGS AND INSTRUCTIONS IN THEIR ENTIRETY PRIOR TO INSTALLATION, OPERATION, SERVICE OR MAINTENANCE. FAILURE TO DO SO CAN RESULT IN DEATH, PERSONAL INJURY AND PROPERTY DAMAGE. If you do not understand these warnings and instructions, or if additional information is desired, please contact the Customer Care Call Center at 800-555-0050.

- Installation, service and maintenance of luminaires must be performed by a qualified professional and in accordance with all federal, state and local laws, regulations and electrical codes. This professional should be familiar with the construction and operation of this product and any hazards involved. If not qualified, do not attempt installation, service or maintenance.
- To reduce the risk of death, personal injury or property damage from fire, electric shock, falling parts, cuts, abrasions and other hazards, please read all warnings and instructions included with the luminaire, on the luminaire's packaging and affixed to the luminaire itself.
- Maintenance of the luminaires should be performed by person(s) familiar with the luminaire's construction and operation and any hazards involved.



WARNING

RISK OF FIRE, ELECTRIC SHOCK OR PERSONAL INJURY

- Disconnect or turn off power before attempting any installation, service or maintenance.
- Verify that supply voltage is correct by referencing the luminaire label information.
- Make all electrical and ground connections in accordance with the National Electrical Code (NEC) and any other applicable laws, regulations or codes.
- All wiring connections should be capped with UL-approved wire connectors.



WARNING

RISK OF PERSONAL INJURY

- Wear gloves and safety glasses at all times when removing luminaire from carton, installing, servicing or performing maintenance.
- Avoid direct eye exposure to the light source while it is on.



WARNING

RISK OF FIRE OR PERSONAL INJURY

- Keep combustible materials away from LED/lamp & lens.
- Do not operate in close proximity to persons, combustible materials or substances affected by heat or drying.



WARNING

RISK OF FIRE, ELECTRIC SHOCK OR PERSONAL INJURY

- Allow LED/lamp & lens to cool before handling.
- Do not touch enclosure or light source.
- Do not exceed maximum wattage marked on luminaire label.
- Follow all manufacturer's warnings, recommendations, instructions and restrictions for driver type, burning position, mounting locations and replacement.



CAUTION

RISK OF PRODUCT DAMAGE

- Never connect luminaires and/or components under load with supply voltage turned on.
- Do not mount or support these luminaires in a manner that can cut the outer jacket or damage wire insulation.
- Do not restrict fixture ventilation. Allow for some volume of airspace around luminaire. Avoid covering luminaire with insulation, foam or other material that will prevent convection or conduction cooling.
- Do not exceed luminaire maximum ambient temperature.
- Do not modify the luminaire.
- Only use luminaire in its intended application and location.
- LED products are polarity sensitive. Ensure proper polarity before installation.
- Electrostatic Discharge (ESD) can damage LED. Personal grounding equipment must be worn during all installation and servicing of the luminaire.
- Do not touch individual electrical components as this can cause ESD, shorten LED life, or impact LED performance. Some components inside the luminaire may not be serviceable. In the unlikely event your luminaire may require service, stop using it immediately and contact the Customer Care Call Center at 800-555-0050.
- Always read the luminaire's complete installation instructions prior to installation for any additional luminaire specific warnings.
- In the case of HID or Fluorescent luminaires, regular re-lamping is required to keep luminaire operating within safe limits
- **Do not install damaged product.** Handling and installing damaged products can potentially increase the risks mentioned. In case of damage and/or missing parts upon arrival of the luminaire, please contact the Customer Care Call Center at 800-555-0050.
- These instructions do not purport to cover all details or variations in equipment nor to provide every possible contingency to meet in connection with installation, operation or maintenance. Should further information be desired or should particular problems arise which are not covered sufficiently for the purchaser's or owner's purposes, this matter should be referred to the Customer Care Call Center at 800-555-0050.
- Please see luminaire specific Installation and Maintenance Instruction for additional warnings or any applicable FCC or regulatory statements. Failure to follow any of these instructions could void luminaire warranties.

Luminaire Maintenance

- Regular luminaire maintenance programs are recommended.
- It is recommended to clean the outside of the luminaire and the refractor/lens.
- Frequency of cleaning will depend on ambient dirt level and minimum light output which is acceptable to user.
- If clean water is not sufficient for cleaning, use a neutral, synthetic, non-scratching and non-abrasive cleaning substance.
- Never use alkaline and/or acetous cleaning substances.
- Make sure that the cleaning substance is carefully removed by rinsing with lots of clean water.
- Signify recommends using a cleaning solution that has a PH between 5 and 8.
- Recycle: For information on how to recycle electronic products and components, please visit www.epa.gov.

443560821950 - REV C

NOTE: Opening luminaire can affect the IP66 and cULus Wet Location seal; therefore, it should be avoided if possible. If it must be opened, it is recommended to be uninstalled first due to luminaire falling hazard. Set luminaire on a flat surface and loosen the 5 top upper lens screws to gain access. Before closing, make sure the sealing O-ring is properly seated on the lower casting and all wires are securely tucked inside luminaire and do not interfere with the seal. Replace 5 top upper lens screws and torque to 14-26 in-lbs; do not overtighten or strip as this will affect the seal.

INSTALLATION INSTRUCTIONS

SOFTVIEW - SURFACE MOUNT / SBO / INDIRECT PENDANT

TOOLS REQUIRED:
• WIRE NUTS (QTY 3)

• PHILLIPS HEAD SCREWDRIVER #2

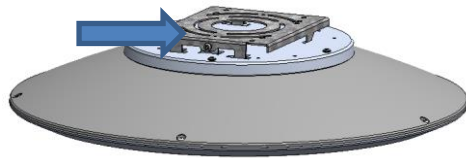
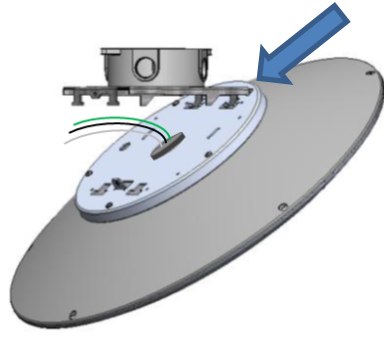
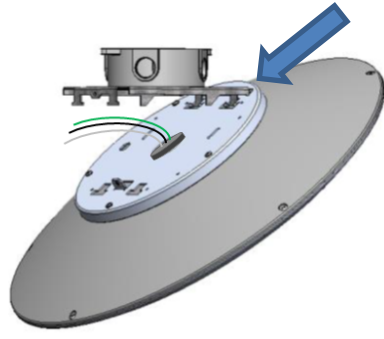
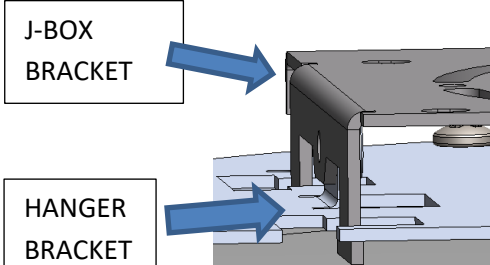
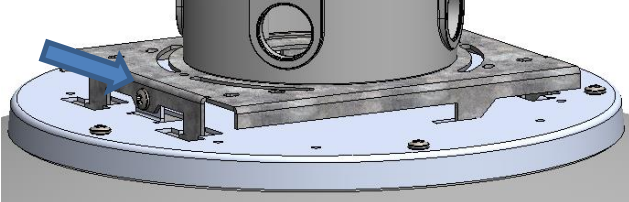
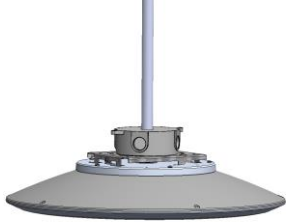
<p>NOTE!: SUR STAMPED UPPER HOUSING SHOWN, ALL THE SAME INSTRUCTIONS APPLY TO SBO WITH DIE-CAST UPPER HOUSING (NOT SHOWN).</p> <p>REMOVE (QTY 1) SCREW LOCATED AT THE FRONT OF THE TOP SHEET METAL BRACKET AND REMOVE THE TOP JUNCTION BOX MOUNTING BRACKET FROM THE TOP. RETAIN THE SET SCREW.</p>	
<p>ATTACH THE TOP MOUNTING BRACKET TO THE JUNCTION BOX USING (QTY 2 - 4) SCREWS PROVIDED WITH THE JUNCTION BOX (SUPPLIED BY OTHERS)</p>	
<p>HANG THE SOFTVIEW ON JUNCTION BOX BRACKET. MAKE FIELD SPLICE CONNECTIONS USING WIRE NUTS (SUPPLIED BY OTHERS). PUSH WIRES INTO JUNCTION BOX. BE SURE THAT ALL WIRES AND WIRE NUTS ARE SECURE AND WILL NOT INTERFERE WITH FINAL INSTALLATION. NOTE: SOFTVIEW WIRES PASS THROUGH IP66 RATED GROMMET SEALING AROUND WIRES.</p>	
<p>PUSH THE FIXTURE UP LEVEL SO THAT THE JUNCTION BRACKET ENGAGES WITH THE FRONT HANGER BRACKET.</p> <p>BE SURE THAT THE JUNCTION BOX BRACKET IS IN FRONT OF THE HANGER BRACKET AND BOTH BRACKETS ARE MAKING CONTACT.</p>	
<p>REPLACE THE SET SCREW LOCATED AT THE FRONT OF THE TOP SHEET METAL BRACKET. TORQUE TO 19 IN. LB.</p> <p>REMOVE THE PROTECTIVE FILM OVER THE BOTTOM LENS</p>	
<p>INDIRECT PENDANT MOUNT: INSTALL A RIGID CONDUIT TO A UL LISTED WET LOCATION JUNCTION BOX FOR PENDANT MOUNT APPLICATIONS. FOR THIS OPTION A 3"-4" ROUND/SQUARE OUTLET WITH THREADED 1/2" - 3/4" NPT HOLE (SUPPLIED BY OTHERS) IS MOUNTED TO THE SURFACE MOUNT BRACKET AS SHOWN ABOVE. THEN A 1/2" - 3/4" PIPE CONDUIT WITH MALE THREADS IS COUPLED TO THE OUTLET HOLE.</p>	

© 2018 Signify Holding. All rights reserved. This document contains information relating to the product portfolio of Signify which information may be subject to change. No representation or warranty as to the accuracy or completeness of the information included herein is given and any liability for any action in reliance thereon is disclaimed. The information presented in this document is not intended as any commercial offer and does not form part of any quotation or contract. All trademarks are owned by Signify Holding or their respective owners.

INSTALLATION INSTRUCTIONS

SOFTVIEW – DIRECT PENDANT MOUNT

TOOLS AND MATERIAL REQUIRED:

- WIRE NUTS (QTY 3)
- ADJUSTABLE WRENCH
- PHILLIPS AND FLAT HEAD SCREWDRIVERS #2

SCREW A 3/4" NPT PIPE (NO LONGER THAN 18", SUPPLIED BY OTHERS) INTO HOLE PROVIDED, PULL WIRES THROUGH PIPE.
 NOTE: SOFTVIEW WIRES PASS THROUGH IP66 RATED GROMMET SEALING AROUND WIRES. IT MAY BE NECESSARY TO SEAL THE CONDUIT INTERNALLY WITH RTV BECAUSE OF CRACKS IN THE CEILING. TIGHTEN CONDUIT WITH WRENCH. THREADS SHOULD ENGAGE 1/2" INTO THE CASTING

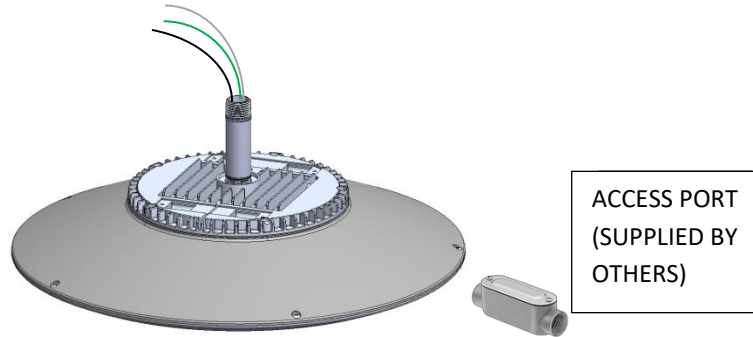

IF THE HEIGHT FROM THE JUNCTION BOX IS TALLER THAN 20", A CONDUIT ACCESS PORT MIGHT BE REQUIRED

MOUNT THE FIXTURE WITH CONDUIT TO AN OUTLET COVER PLATE. IT IS RECOMMENDED THAT THE JUNCTION BOX BE OUTDOOR WATERTIGHT RATED, AND THE COVER HAVE A 3/4" HOLE FOR EASE OF ASSEMBLY AND RELIABLE WATER PROTECTION. (SUPPLIED BY OTHERS)

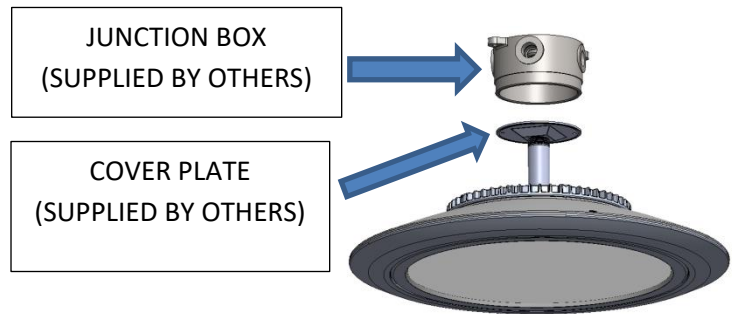

MAKE THE FIELD ELECTRICAL CONNECTIONS TO THE FIXTURE. SCREW THE COVER PLATE MOUNTING FASTENERS TO THE OUTLET JUNCTION BOX.
 REMOVE PROTECTIVE COVER FILM FROM LENS

GENERAL: Upon receipt inspect for any freight damage which should be brought to the attention of the delivering carrier. See "Damage and Shortage Claims" for proper steps in filing claims with the carrier. Compare the catalog description listed on the packing slip with the label on the carton to assure you have received the correct material.

© 2018 Signify Holding. All rights reserved. This document contains information relating to the product portfolio of Signify which information may be subject to change. No representation or warranty as to the accuracy or completeness of the information included herein is given and any liability for any action in reliance thereon is disclaimed. The information presented in this document is not intended as any commercial offer and does not form part of any quotation or contract. All trademarks are owned by Signify Holding or their respective owners.

INSTALLATION INSTRUCTIONS

SOFTVIEW – TRUNNION MOUNT

TOOLS AND MATERIAL REQUIRED:

- WIRE NUTS (QTY 3 - 5)
- ADJUSTABLE WRENCH

- PHILLIPS AND FLAT HEAD SCREWDRIVERS #2

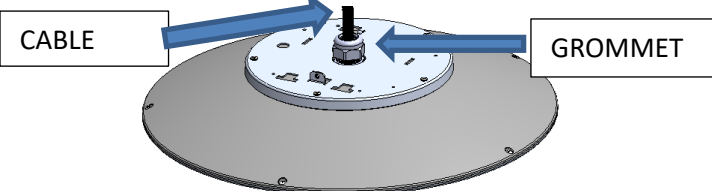
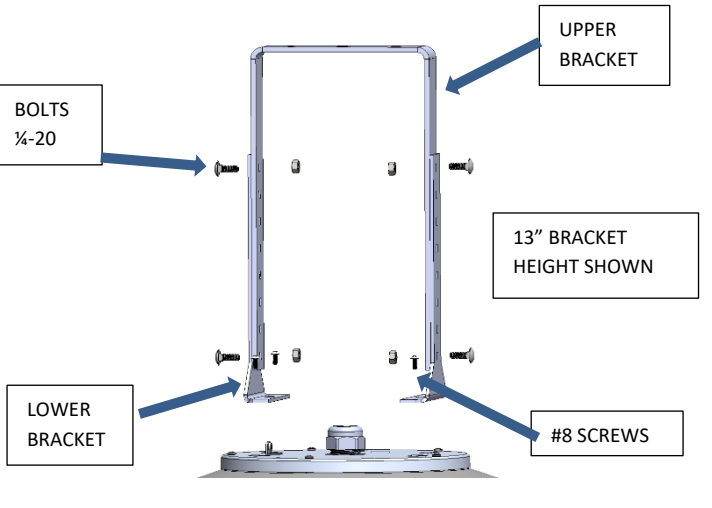
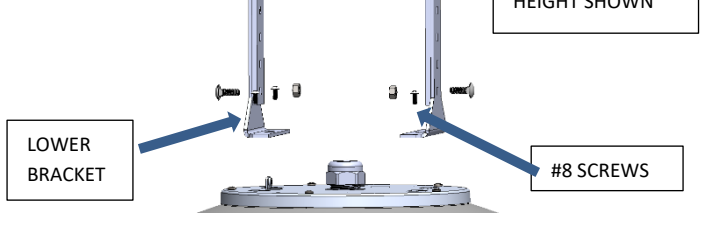
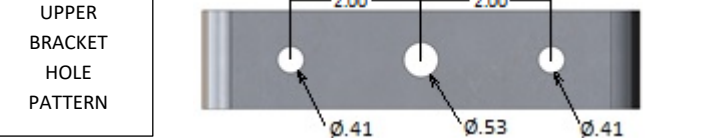
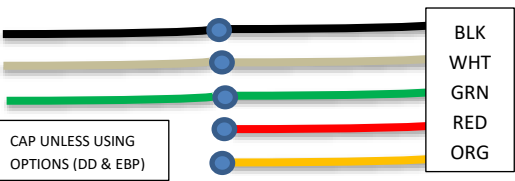
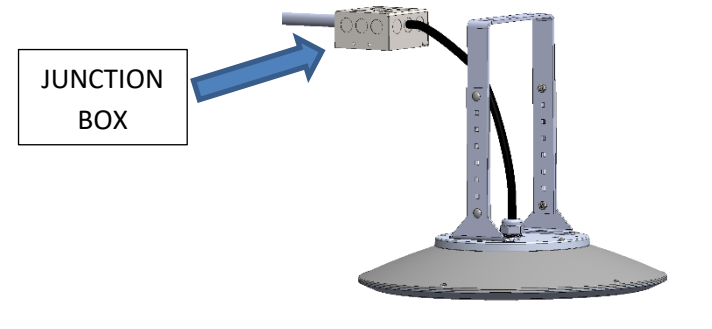
<p>REMOVE SOFTVIEW FROM BOX. TRUNNION VERSION OF LUMINAIRE WILL HAVE CABLE THROUGH IP66 RATED GROMMET EXTENDING FROM CENTER WIRE WAY OUT FROM THE TOP. TRUNNION BRACKET ASSEMBLY WILL BE IN A SEPARATE BOX.</p>	 <p>CABLE</p> <p>GROMMET</p>
<p>ATTACH LOWER TRUNNION BRACKET TO TOP OF CASTING WITH #8 SCREWS ON BOTH SIDES. (TORQUE 19 IN. LBS.) ADJUST HEIGHT OF UPPER BRACKET WITHIN A RANGE OF 13" TO 21". INSERT 4 1/4"-20 CARRIAGE BOLTS AND NUTS TO SECURE LOWER BRACKET TO UPPER BRACKET. (TORQUE 65 IN. LBS.)</p>	 <p>BOLTS 1/4"-20</p> <p>UPPER BRACKET</p> <p>13" BRACKET HEIGHT SHOWN</p> <p>LOWER BRACKET</p> <p>#8 SCREWS</p>
<p>MOUNT THE FIXTURE WITH AT LEAST TWO 3/8" CONCRETE ANCHOR BOLTS (SUPPLIED BY OTHERS) PROTRUDING 1" FROM CEILING SURFACE TO THE HOLE PATTERN</p>	 <p>UPPER BRACKET HOLE PATTERN</p> <p>2.00</p> <p>2.00</p> <p>Ø.41</p> <p>Ø.53</p> <p>Ø.41</p>
<p>ATTACH CABLE TO JUNCTION BOX USING APPROPRIATE CABLE GLAND HARDWARE (SUPPLIED BY OTHERS). COMPLETE WIRING AND INSTALL JUNCTION BOX COVER.</p>	 <p>JUNCTION BOX</p>
<p>SCREW THE COVER PLATE MOUNTING FASTENERS TO THE OUTLET JUNCTION BOX. REMOVE PROTECTIVE COVER FILM FROM LENS.</p> <p>LINE WIRES - 5 WIRE CORD FROM LOAD</p>  <p>CAP UNLESS USING OPTIONS (DD & EBP)</p> <p>BLK</p> <p>WHT</p> <p>GRN</p> <p>RED</p> <p>ORG</p>	 <p>JUNCTION BOX</p>

© 2018 Signify Holding. All rights reserved. This document contains information relating to the product portfolio of Signify which information may be subject to change. No representation or warranty as to the accuracy or completeness of the information included herein is given and any liability for any action in reliance thereon is disclaimed. The information presented in this document is not intended as any commercial offer and does not form part of any quotation or contract. All trademarks are owned by Signify Holding or their respective owners.