



**Stonco LytePro Area LPA** pole mounted LED Luminaire is a value-engineered solution with the perfect combination of affordability, quality, and performance. Available in both make-to-stock and make-to-order options, LytePro is the flexible choice for any project. With its lightweight design and easy-to-install features, it is perfect for contractors and installers who want a hassle-free installation process. Stonco LytePro Area is the ideal choice for your area lighting needs.

Project: \_\_\_\_\_  
 Location: \_\_\_\_\_  
 Cat.No: \_\_\_\_\_  
 Type: \_\_\_\_\_  
 Lamps: \_\_\_\_\_ Qty: \_\_\_\_\_  
 Notes: \_\_\_\_\_

### Ordering guide

**Example:** LPA-A08-740-T3-HSS-120V-PCB-BZ

Prefix	Configuration	CCT/CRI	Distribution	Shielding	Voltage
<b>LPA</b>					
LPA LytePro Area	<b>A01</b> <sup>1</sup> 2,500 lumens <b>A02</b> <sup>1</sup> 4,500 lumens <b>A03</b> 6,000 lumens <b>A04</b> 8,000 lumens <b>A05</b> 10,000 lumens <b>A06</b> 12,000 lumens <b>A07</b> 16,000 lumens <b>A08</b> 19,000 lumens <b>A09</b> 22,000 lumens <b>A10</b> 25,000 lumens <b>A11</b> 29,000 lumens	<b>730</b> 70CRI, 3000K <b>740</b> 70CRI, 4000K <b>750</b> <sup>2</sup> 70CRI, 5000K	<b>T2</b> Type 2 Medium <b>T3</b> Type 3 Medium <b>T4</b> Type 4 Medium <b>T5</b> Type 5 Medium	- None <b>HSS</b> House Side Shield	<b>120V</b> 120 Volts <b>208V</b> 208 Volts <b>240V</b> 240 Volts <b>277V</b> 277 Volts <b>UNV</b> 120-277 Volts <b>347V</b> 347 Volts <b>480V</b> 480 Volts <b>HVU</b> 347-480 Volts
<b>Lighting Controls</b> <sup>5</sup>		<b>Electrical Controls</b> <sup>6</sup>			<b>Finish</b>
- None <b>DLEA</b> Dimming leads externally accessible <b>FAWS</b> Field Adjustable Wattage Selector <b>MRL2</b> Motion Response Dim to 50% L2 Lens <b>MRL3</b> Motion Response Dim to 50% L3 Lens <b>MRL7</b> Motion Response Dim to 50% L7 Lens <b>WIAPL</b> <sup>3,4</sup> Outdoor Interact - Low Mounting <b>WIAPH</b> <sup>3,4</sup> Outdoor Interact - High Mounting		- None <b>TR7</b> 7-Pin twist lock w/ 0-10V <b>TRPC</b> 7-Pin twist lock w/ 0-10V & On/Off Photocell (PH8) <b>TRSC</b> 7-Pin twist lock w/ 0-10V & Shorting Cap (PH9) <b>PCB</b> <sup>7</sup> Photo Control button			<b>BK</b> Black <b>BZ</b> Bronze <b>DG</b> Dark Gray <b>MG</b> Medium Gray <b>WH</b> White

1. Not available at 347-480V [HVU].
2. Extended lead times apply. Contact factory for details.
3. Only available with Lumen Packages A03-A08 at 120-277V [UNV]
4. Only available with Lumen Packages A06-A08 at 347-480V [HVU]

5. Mutually exclusive. Not allowed with other lighting controls options.
6. If selected with lighting control option, dimming leads will not be connected to LED Driver.
7. Must specify voltage. Cannot be selected with UNV or HVU.

### Stocked luminaires – Stonco ordering guide

Catalog Number	Description
912300004181	LPA-A06-740-T3-UNV-FAWS-TRPC-BZ
912300004183	LPA-A06-740-T4-UNV-FAWS-TRPC-BZ
912300004185	LPA-A11-740-T3-UNV-FAWS-TRPC-BZ
912300004187	LPA-A11-740-T4-UNV-FAWS-TRPC-BZ



LytePro with motion sensor



# LPA LytePro Area

## LED area light

Weight	EPA
7.7lbs (3.5kg)	0.03m <sup>2</sup> (0.38ft <sup>2</sup> )

### Dimensions

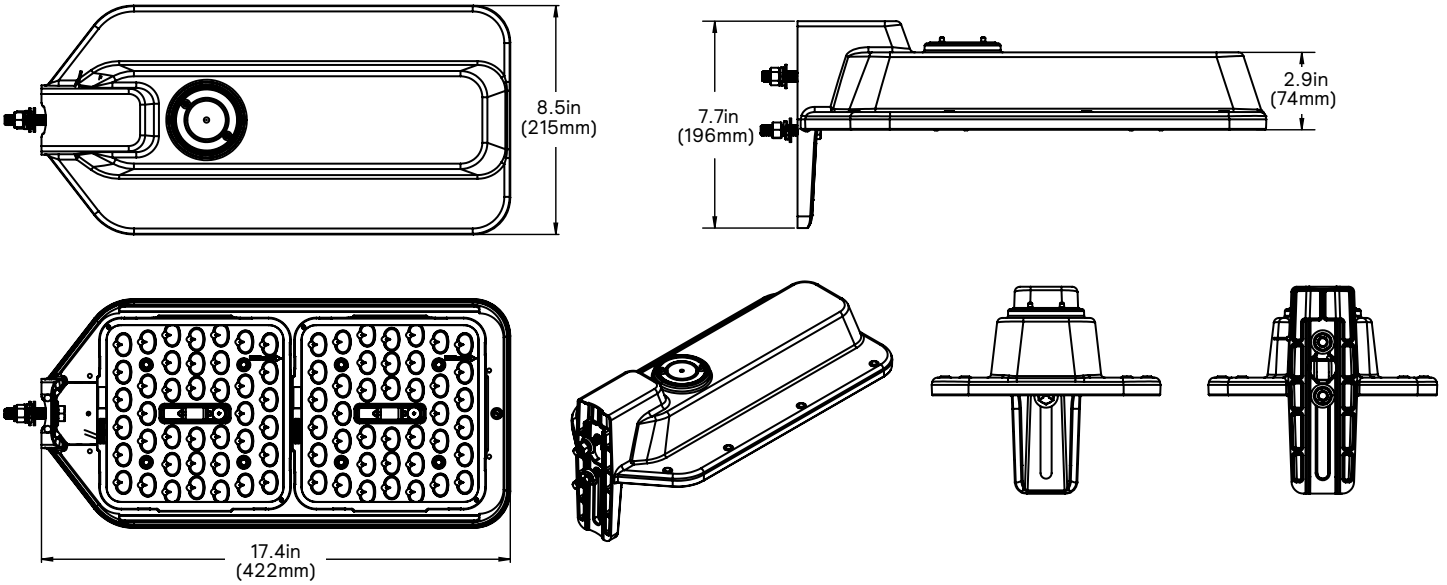

### Standard Drill Pattern

#### Drill Template #5

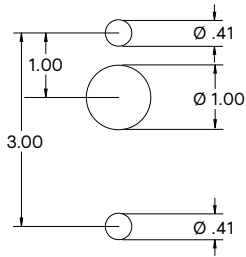

### Standard Arm Mounting Hole Pattern

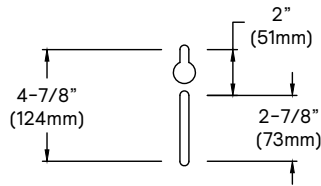

### LED Wattage and Lumen Values

Performance Package	System Watts	Distribution Type	70 CRI			70 CRI			70 CRI		
			3000K			4000K			5000K		
			Lumen Output	BUG Rating	Efficacy (LPW)	Lumen Output	BUG Rating	Efficacy (LPW)	Lumen Output	BUG Rating	Efficacy (LPW)
A01	15	T2	2659	B1-U0-G1	180	2743	B1-U0-G1	185	2743	B1-U0-G1	185
		T3	2664	B1-U0-G1	180	2748	B1-U0-G1	186	2748	B1-U0-G1	186
		T4	2690	B1-U0-G1	182	2775	B1-U0-G1	187	2775	B1-U0-G1	187
		T5	2551	B2-U0-G1	172	2631	B2-U0-G1	178	2631	B2-U0-G1	178
A02	24	T2	4287	B1-U0-G1	176	4422	B1-U0-G1	182	4422	B1-U0-G1	182
		T3	4295	B1-U0-G1	177	4431	B1-U0-G1	182	4431	B1-U0-G1	182
		T4	4337	B1-U0-G1	178	4474	B1-U0-G1	184	4474	B1-U0-G1	184
		T5	4113	B3-U0-G2	169	4242	B3-U0-G2	175	4242	B3-U0-G2	175
A03	34	T2	5814	B2-U0-G2	171	5997	B2-U0-G2	176	5997	B2-U0-G2	176
		T3	5824	B1-U0-G1	171	6008	B1-U0-G1	176	6008	B1-U0-G1	176
		T4	5882	B1-U0-G2	173	6067	B1-U0-G2	178	6067	B1-U0-G2	178
		T5	5577	B3-U0-G2	164	5753	B3-U0-G2	169	5753	B3-U0-G2	169
A04	52	T2	7619	B2-U0-G2	146	7859	B2-U0-G2	151	7859	B2-U0-G2	151
		T3	7633	B2-U0-G2	147	7874	B2-U0-G2	151	7874	B2-U0-G2	151
		T4	7708	B1-U0-G2	148	7951	B1-U0-G2	153	7951	B1-U0-G2	153
		T5	7309	B3-U0-G2	140	7540	B3-U0-G2	145	7540	B3-U0-G2	145

# LPA LytePro Area

## LED area light

### LED Wattage and Lumen Values (continued)

Performance Package	System Watts	Distribution Type	70 CRI			70 CRI			70 CRI		
			3000K			4000K			5000K		
			Lumen Output	BUG Rating	Efficacy (LPW)	Lumen Output	BUG Rating	Efficacy (LPW)	Lumen Output	BUG Rating	Efficacy (LPW)
A05	63	T2	9546	B2-U0-G2	152	9847	B2-U0-G2	156	9847	B2-U0-G2	156
		T3	9564	B2-U0-G2	152	9865	B2-U0-G2	157	9865	B2-U0-G2	157
		T4	9658	B1-U0-G2	153	9962	B2-U0-G2	158	9962	B2-U0-G2	158
		T5	9158	B3-U0-G3	145	9447	B3-U0-G3	150	9447	B3-U0-G3	150
A06	78	T2	11319	B2-U0-G2	145	11676	B3-U0-G3	150	16295	B3-U0-G3	157
		T3	11339	B2-U0-G2	145	11697	B2-U0-G2	150	16325	B3-U0-G3	157
		T4	11451	B2-U0-G2	147	11812	B2-U0-G2	151	16485	B2-U0-G3	159
		T5	10858	B4-U0-G3	139	11201	B4-U0-G3	144	15632	B4-U0-G3	150
A07	104	T2	15797	B3-U0-G3	152	16295	B3-U0-G3	157	18072	B3-U0-G3	153
		T3	15825	B3-U0-G3	152	16325	B3-U0-G3	157	18106	B3-U0-G3	153
		T4	15981	B2-U0-G2	154	16485	B2-U0-G3	159	18283	B2-U0-G3	155
		T5	15154	B4-U0-G3	146	15632	B4-U0-G3	150	17337	B4-U0-G3	147
A08	118	T2	17520	B3-U0-G3	148	18072	B3-U0-G3	153	21410	B3-U0-G3	156
		T3	17552	B3-U0-G3	149	18106	B3-U0-G3	153	21450	B3-U0-G3	157
		T4	17724	B2-U0-G3	150	18283	B2-U0-G3	155	21660	B3-U0-G3	158
		T5	16807	B4-U0-G3	142	17337	B4-U0-G3	147	20539	B5-U0-G4	150
A09	137	T2	20756	B3-U0-G3	152	21410	B3-U0-G3	156	21410	B3-U0-G3	156
		T3	20794	B3-U0-G3	152	21450	B3-U0-G3	157	21450	B3-U0-G3	157
		T4	20998	B3-U0-G3	153	21660	B3-U0-G3	158	21660	B3-U0-G3	158
		T5	19911	B5-U0-G4	145	20539	B5-U0-G4	150	20539	B5-U0-G4	150
A10	161	T2	23850	B3-U0-G3	148	24603	B3-U0-G3	153	24603	B3-U0-G3	153
		T3	23894	B3-U0-G3	148	24648	B3-U0-G3	153	24648	B3-U0-G3	153
		T4	24129	B3-U0-G3	150	24890	B3-U0-G4	155	24890	B3-U0-G4	155
		T5	22880	B5-U0-G4	142	23601	B5-U0-G4	147	23601	B5-U0-G4	147
A11	179	T2	27051	B3-U0-G3	151	27904	B3-U0-G3	156	27904	B3-U0-G3	156
		T3	27100	B3-U0-G4	151	27955	B3-U0-G4	156	27955	B3-U0-G4	156
		T4	27366	B3-U0-G4	153	28229	B3-U0-G4	158	28229	B3-U0-G4	158
		T5	25950	B5-U0-G4	145	26768	B5-U0-G4	150	26768	B5-U0-G4	150

### Predicted lumen depreciation data

Predicted performance derived from LED manufacturer's data and engineering design estimates, based on IESNA LM-80 methodology. Actual experience may vary due to field application conditions. L<sub>70</sub> is the predicted time when LED performance depreciates to 70% of initial lumen output. Calculated per IESNA TM21-11. Published L<sub>70</sub> hours limited to 6 times actual LED test hours

Ambient Temperature °C	Calculated L <sub>70</sub> Hours	L <sub>70</sub> per TM-21	Lumen Maintenance % at 60,000 hrs
up to 40°C	>100,000 hours	>100,000 hours	>95%

### Optical distributions

#### LytePro T2

Type 2 Medium

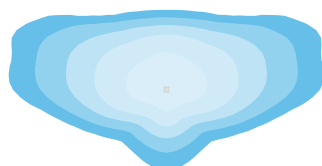

#### LytePro T3

Type 3 Medium

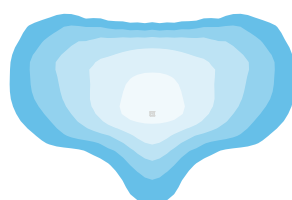

#### LytePro T4

Type 4 Medium

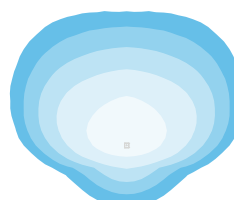

#### LytePro T5

Type 5 Medium

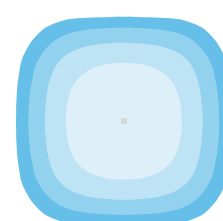

# LPA LytePro Area

## LED area light

### Specifications

#### General Description

LytePro Area LPA combines excellent performance, design and value to meet the needs of the energy and budget conscious. LytePro is designed for Pole Mount Applications mounts to either round or square pole and features an integral retrofit arm to avoid pole drilling for luminaire replacement. 4 SKU's for United States and 8 SKU's for Canada are available as in-stock configurations (2-day quick ship) as well as make-to-order offering for jobs with specific lighting or control requirements.

#### Housing

Die-cast housing contains LED Driver, electronic components, and features for Daylight sensing or controls options. LED Sheet metal door is constructed of formed Aluminum to keep LEDs cool and maximize efficacy and lumen maintenance. Housing and Door are Powder Coated to withstand weather and harsh environments. Paint Coating has been Salt Spray tested to ASTM B117 with a scribe rating of 8 at 1,000 hours.

#### Vibration Resistance

LytePro Area is tested and rated to standards set forth in ANSI C136.31-2018 Level 1 for normal applications.

#### Mounting

Luminaire arm mounts to square and round poles 3-4" OD standard. Standard arm casting can accommodate existing bolt spacing from 2" to 4-7/8". Luminaire comes boxed with mounting hardware and installation instructions.

#### IP Rating

LED Modules are Rated to IP66. Housing carries UL wet location rating.

#### LED Board and Array

LED modules are available in IES Distributions 2, 3, 4, & 5 with available clip on shielding to reduce backlight. LytePro Area offers 3000k, 4000k, and 5000k color temperature options at 70CRI with efficacies up to 187 lumens per watt and 28,000 total lumens.

#### Electrical

Driver efficiency (>90% standard). 120-277V and 347-480V available. All drivers are dimmable. Temp range: -40°C (-40°F) to 40°C (104°F). Open/short circuit protection. Inherent surge protection up to (10KVA). All components are certified RoHS compliant.

**Surge protection (SP1):** Surge protection device tested in accordance with ANSI/IEEE C62.45 per ANSI/IEEE C62.41.2 Scenario I Category C High Exposure 10kV/10kA waveforms for Line-Ground, Line-Neutral and Neutral-Ground, and in accordance with DOE MSSLC Model Specification for LED Roadway Luminaires Appendix D Electrical Immunity High test level 10kV/10kA.

#### Listings

Product is UL listed suitable for Wet Locations. Suitable for use in ambients from -40°C to 40°C on all configurations. Lumen Packages A01-A09 are available to 50°C. Configurations A10 and A11 with shielding are limited to 30°C. LytePro Area luminaire is tested per LM-79 and TM-15 (IESNA) certifying their photometric performance.

Luminaire designed with 0% uplight (U0 per IESNA TM-15). CCTs 3000k lower are Dark Sky Compliant.

#### Finish

Each luminaire receives a fade and abrasion resistant, electrostatically applied, thermally cured, triglycidal isocyanurate (TGIC) textured polyester powdercoat finish.

#### Warranty

LytePro luminaires feature a 5-year limited warranty see [www.signify.com/warranties](http://www.signify.com/warranties) for complete details and exclusions.

#### Dimming Control Options

**Field Adjustable Wattage Selector (FAWS):** Luminaire equipped with the ability to manually adjust the wattage in the field to reduce total luminaire lumen output and light levels. Comes pre-set to the highest position at the lumen output selected. Use chart below to estimate reduction in lumen output desired. Cannot be used with other control options or motion response.

#### Motion Response Options

**Motion Response (MRL2/L3/L7):** Motion Response sensor modules are mounted to the outside of the luminaire when selected and connected to a 0-10V driver. Motion sensor default settings are as such: when motion is detected the light levels will ramp up to 100%. Hold time or up time will keep luminaire at full brightness for 5 mins. If no motion is detected during up time, the luminaire will dim to 10% and remain at this level indefinitely. Default settings can be modified in the factory if necessary. Contact factory support to assist. Programming remote also available, see luminaire accessories for ordering code.

**Infrared Motion Response Lenses:** LytePro Area motion sensor uses Passive Infrared Detection and is available with 3 sensor lens options depending on mounting height. #2 Lens is designed for mounting heights up to 8'. Lens #3 is for mounting heights 8' to 20' and L7 for 20' to 40'.

with L2 #2 lens

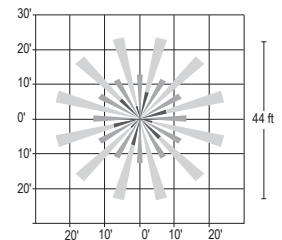
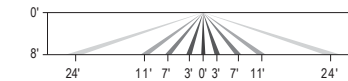

with L3 #3 lens

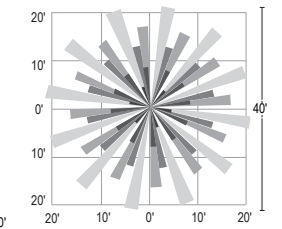
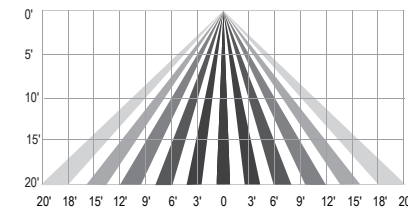

with L7 #7 lens

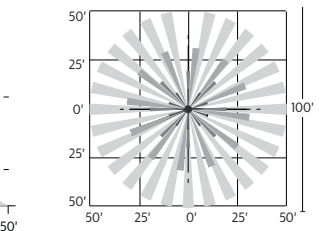
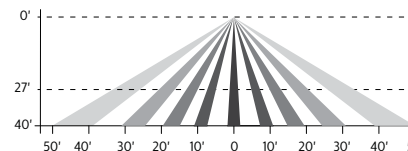

# LPA LytePro Area

## LED area light

### Specifications

**Outdoor Interact:** Scalable connected sensor with integral occupancy and daylight sensing, supports wireless mesh connectivity. Sensor works in the Foundation mode when configured without a gateway or in an Interact Advanced mode if a compatible gateway (can be added later) is used. Interact offers an app, a portal and a broad portfolio of Interact ready Indoor and Outdoor luminaires, lamps and retrofit kits all working on the same system. Startup is implemented via Interact Pro App (available in iOS® or Android®) and Bluetooth® connectivity. The app provides flexibility to choose between a gateway or non gateway mode for setup. Setup with the gateway requires wired Internet access to the gateway. Prepare project configuration steps remotely and use IRT9015 remote accessory (ordered separately) or the App on-site to identify and group devices together. WIAP includes SR driver and SR receptacle. Daylight harvesting supported through dimming - activated via the Interact app. Sensors are available in black or white finish and high or low mounting height lenses. IP66 rated.

For more information on Interact visit:

[www.interact-lighting.com/interactproscalablesystem](http://www.interact-lighting.com/interactproscalablesystem)

LW low sensor

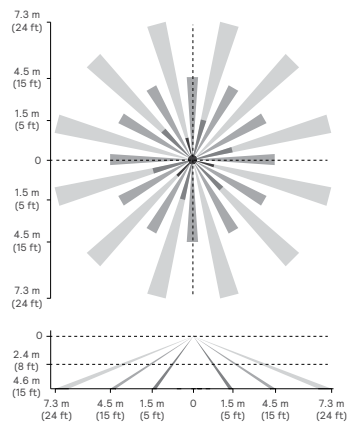

HW high sensor

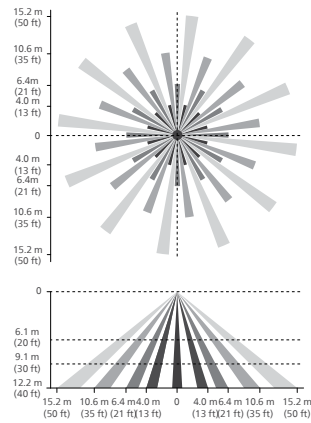

© 2024 Signify Holding. All rights reserved. The information provided herein is subject to change, without notice. Signify does not give any representation or warranty as to the accuracy or completeness of the information included herein and shall not be liable for any action in reliance thereon. The information presented in this document is not intended as any commercial offer and does not form part of any quotation or contract, unless otherwise agreed by Signify.

Signify North America Corporation  
400 Crossing Blvd, Suite 600  
Bridgewater, NJ 08807  
Telephone: 800-555-0050

Signify Canada Ltd.  
281 Hillmount Road,  
Markham, ON, Canada L6C 2S3  
Telephone: 800-668-9008

All trademarks are owned by Signify Holding or their respective owners.