

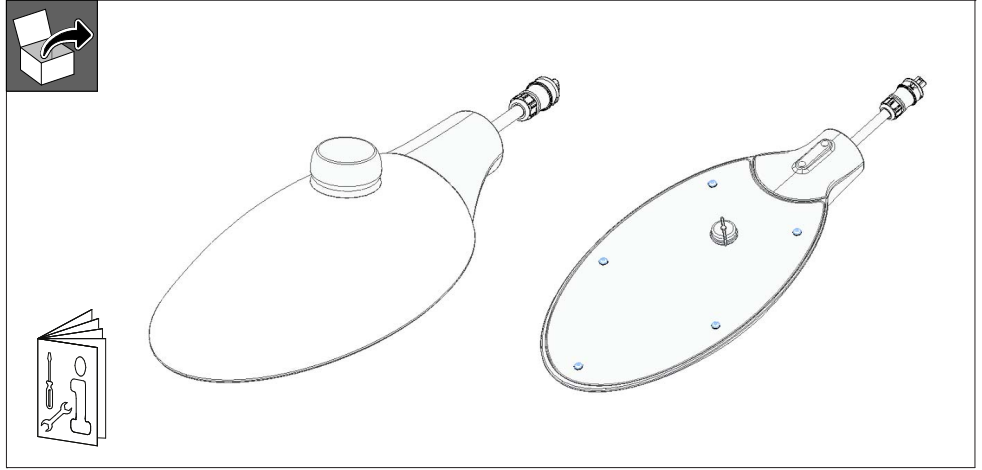

MileWide2 Disassembly instruction

BPP435 / BPP436



List of Tools

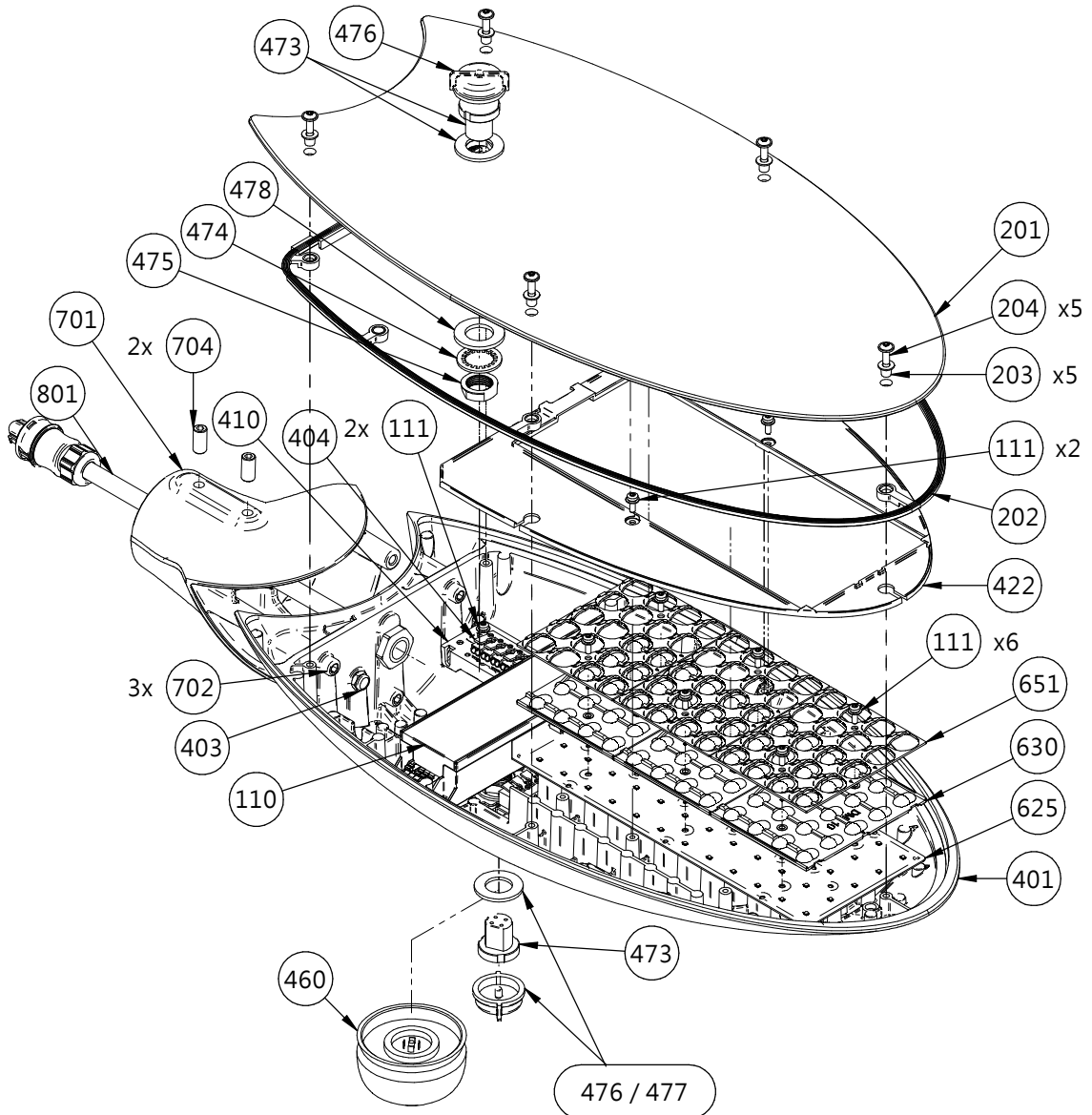
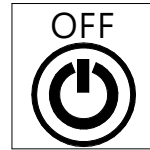
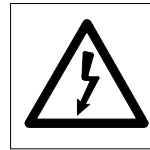
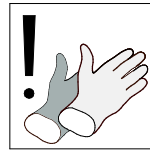
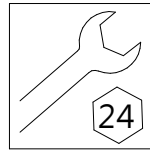
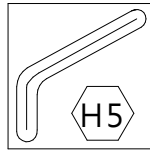
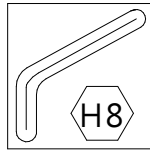
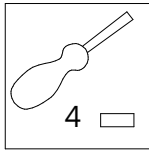
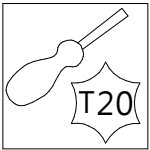

511 - 442710435610

2026-03-13
© Signify Holding
All rights reserved

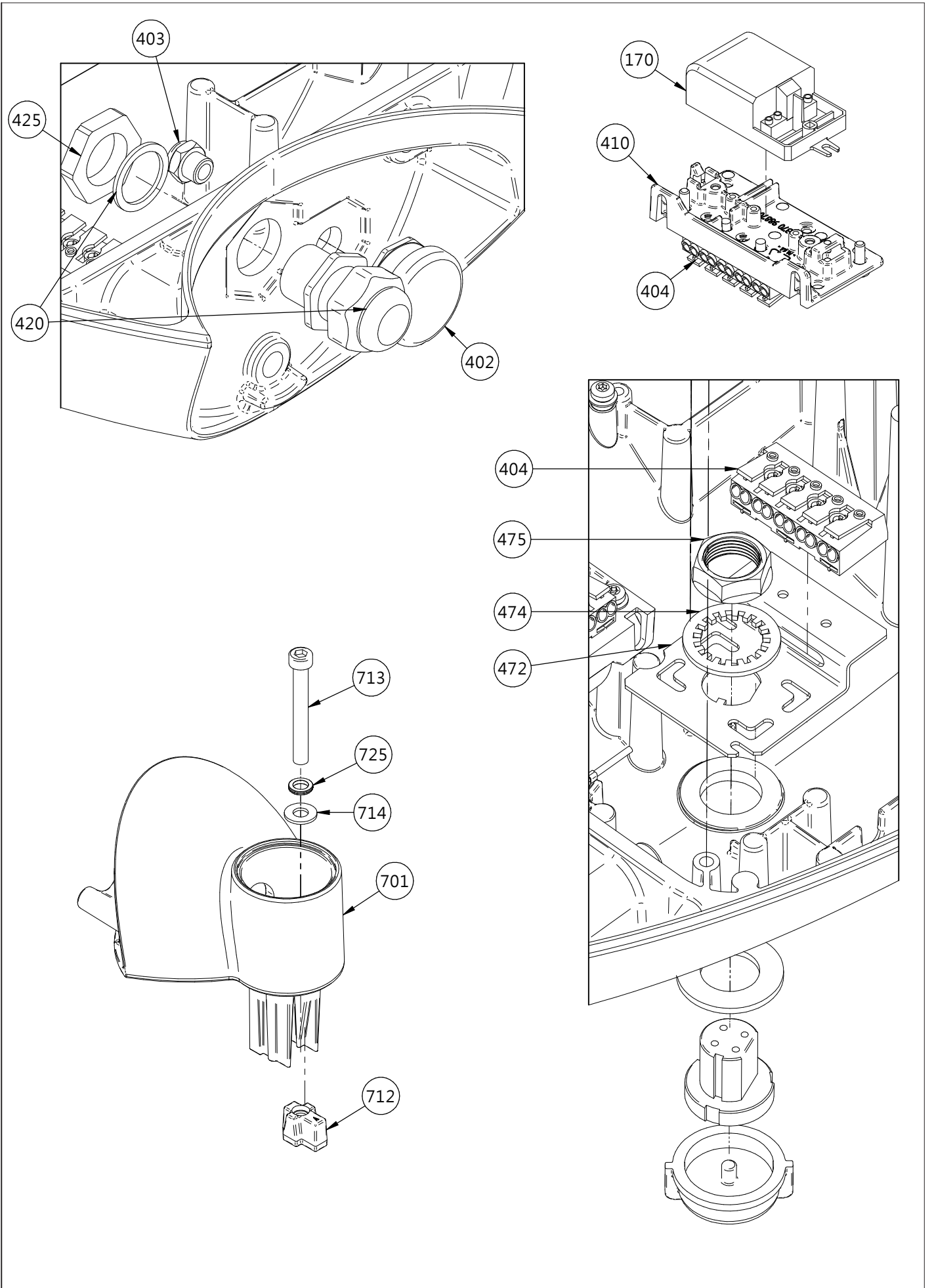

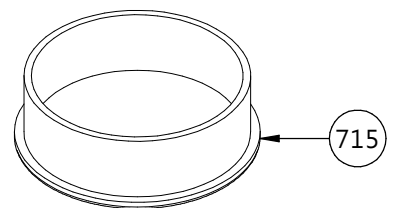
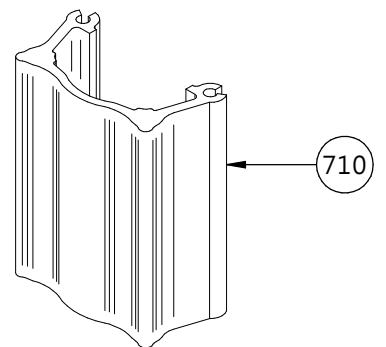
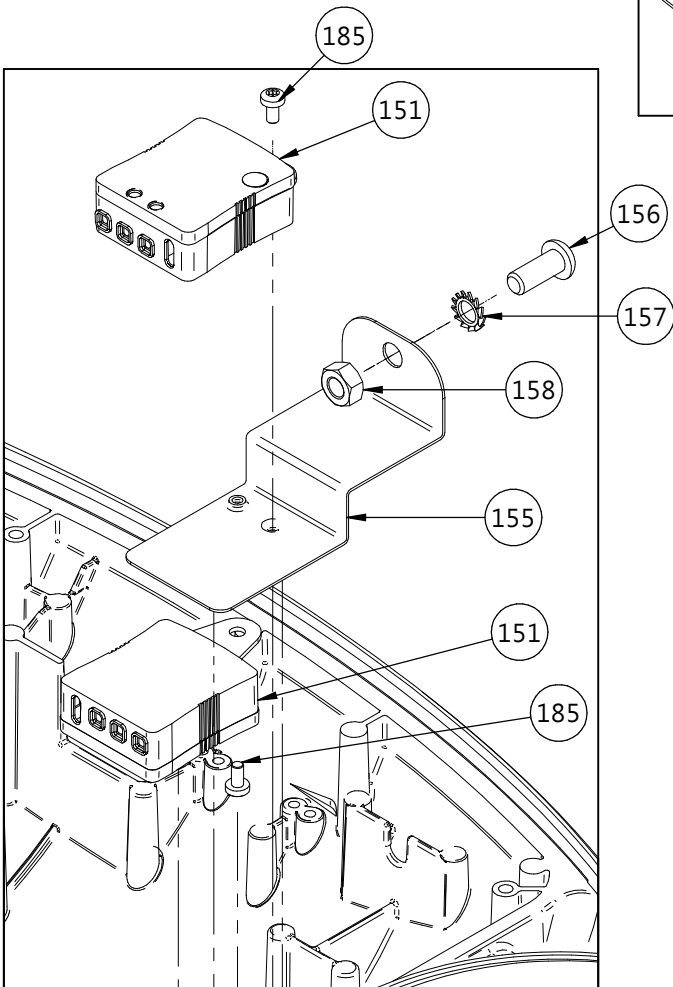
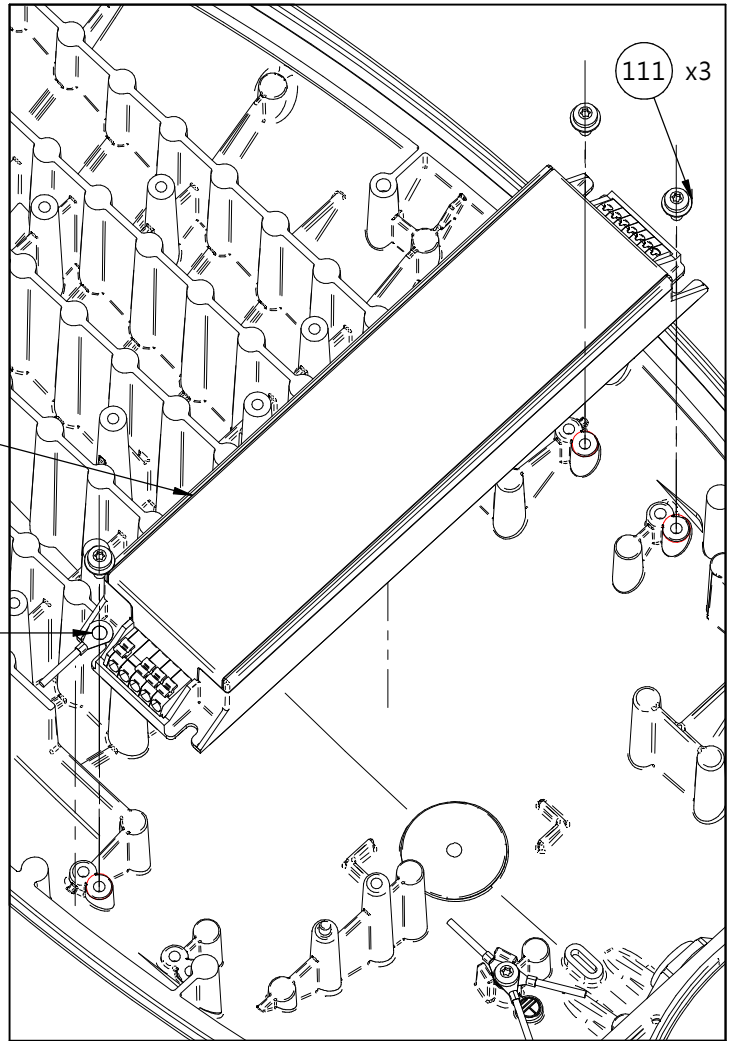

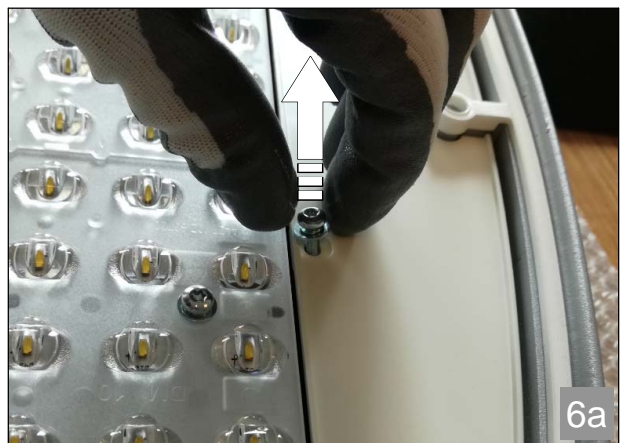
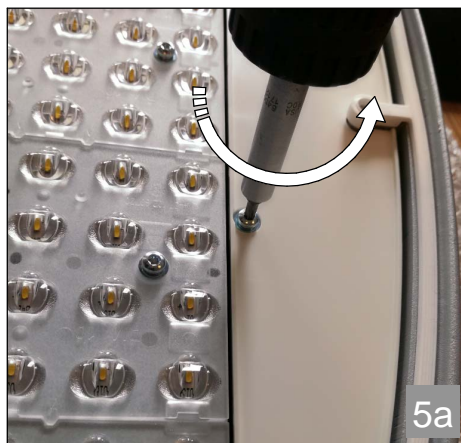
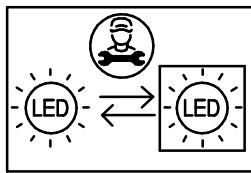
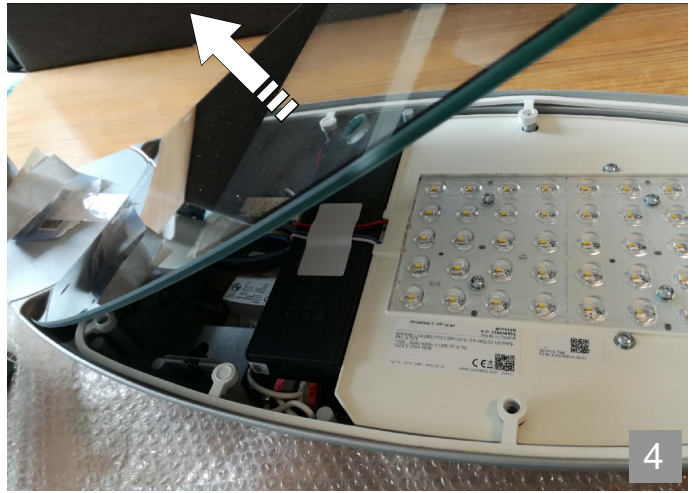
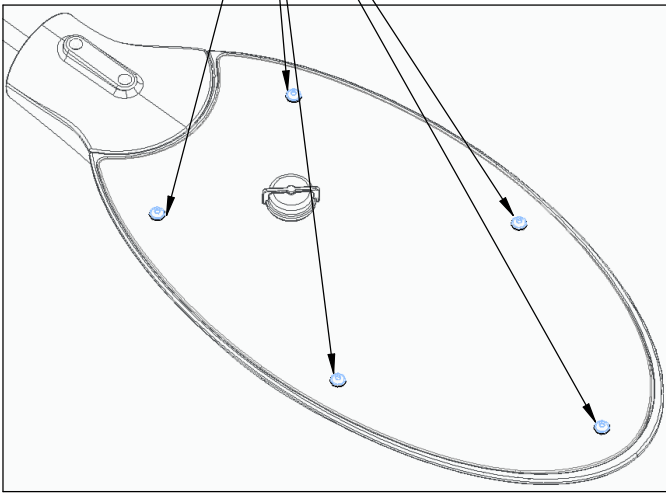
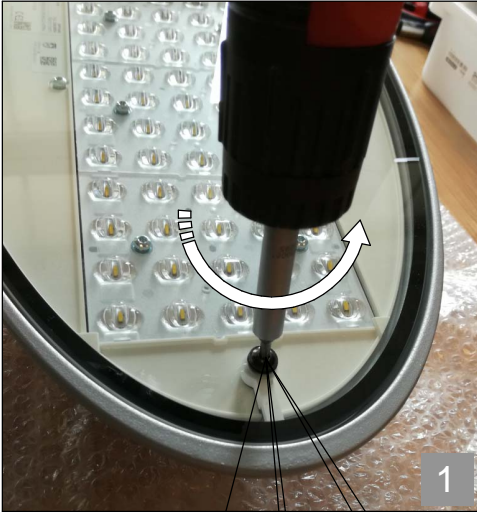

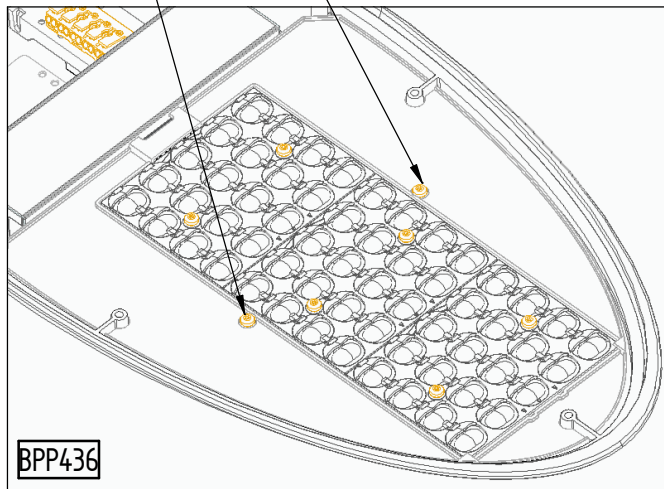
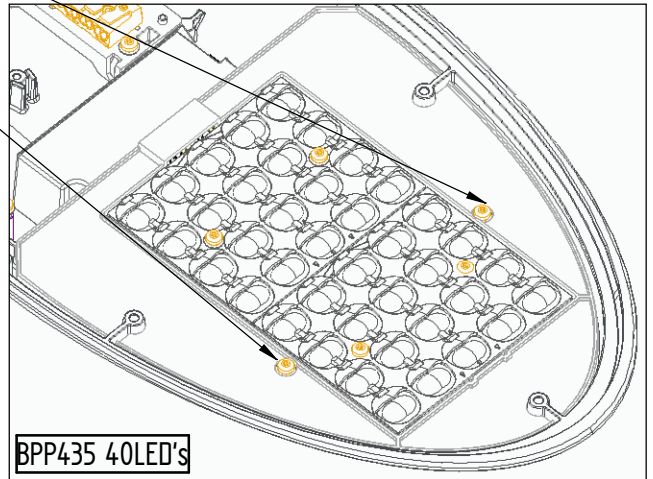
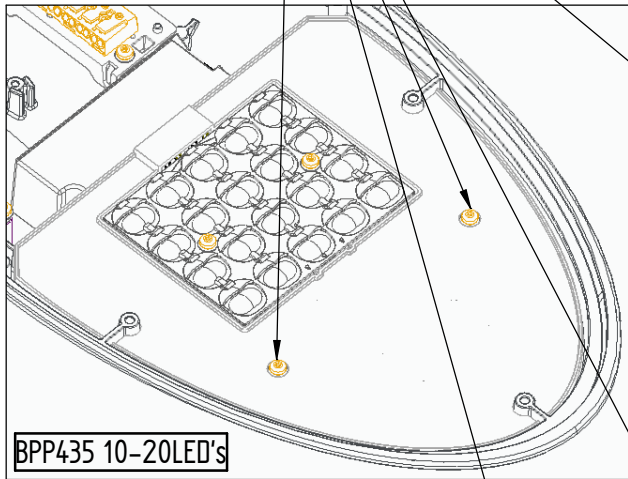



9a



10a

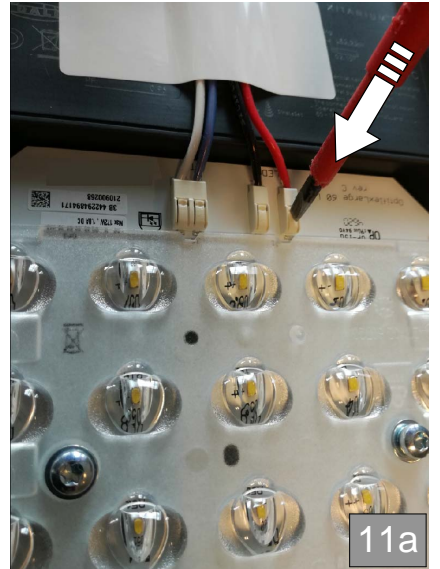

11a

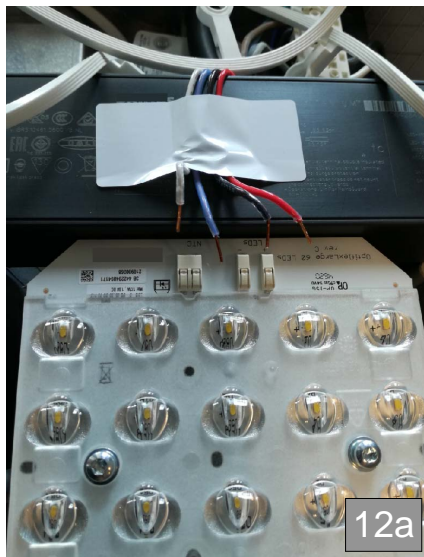

12a

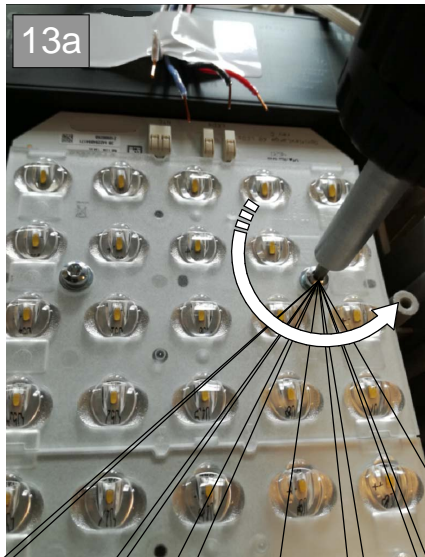

13a



14a

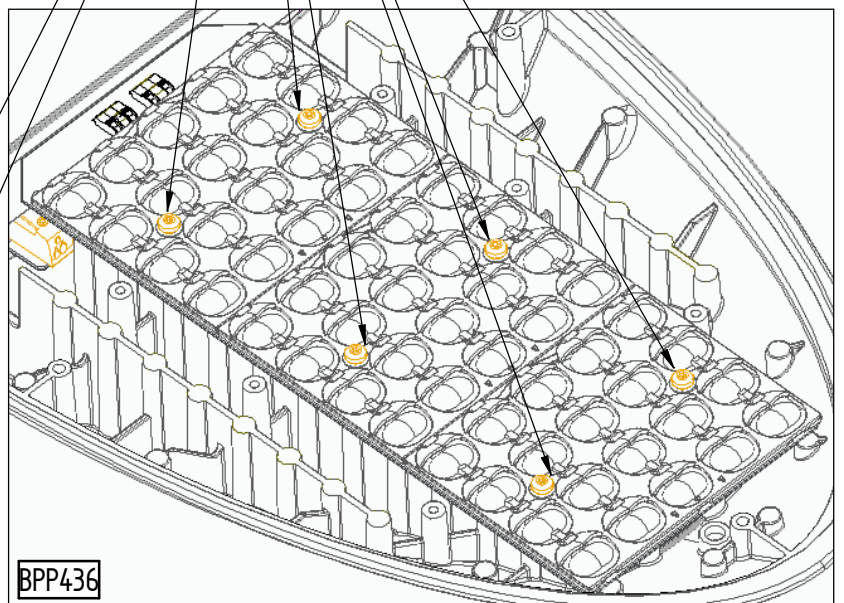
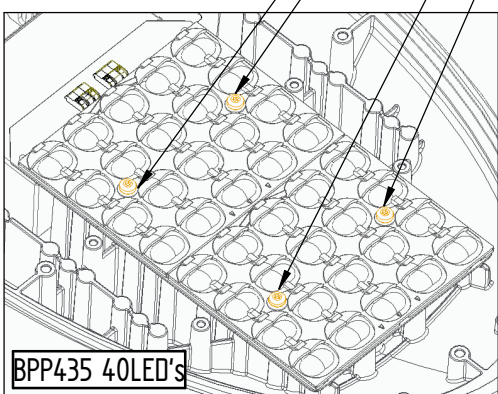
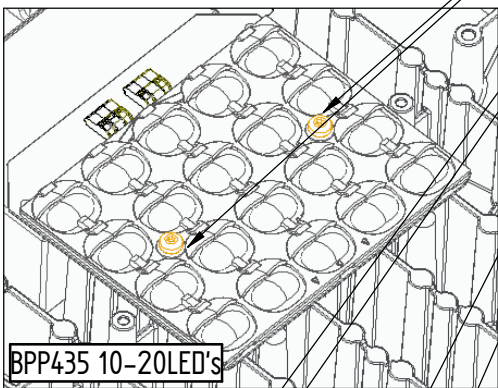

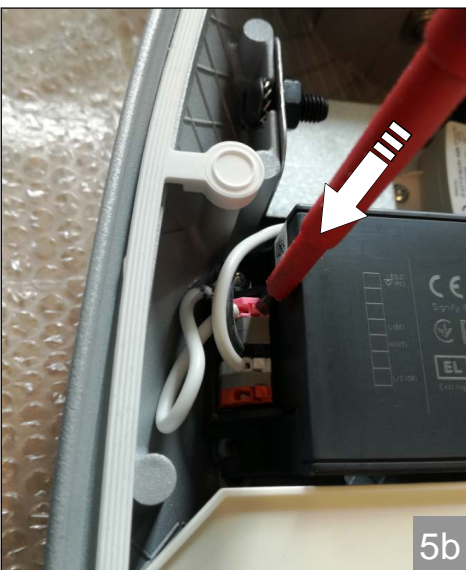
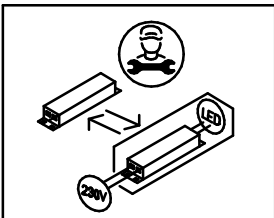
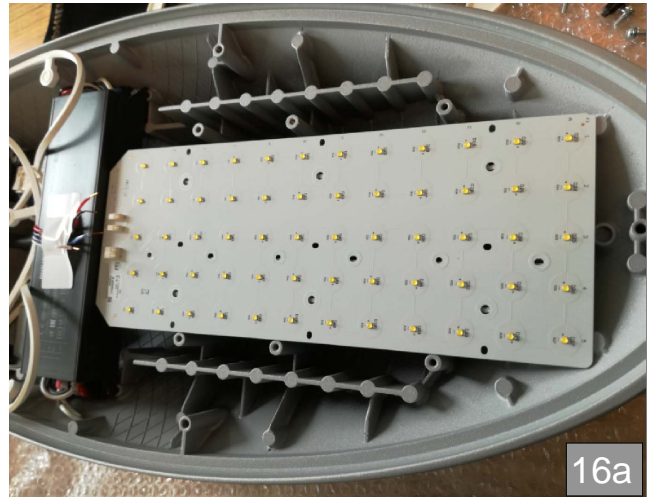
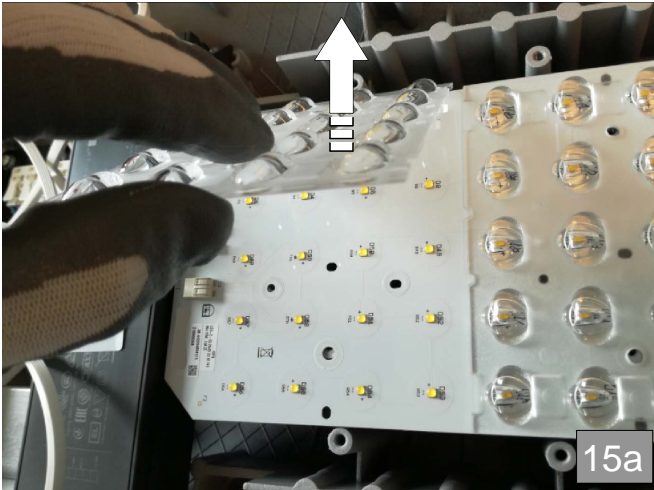

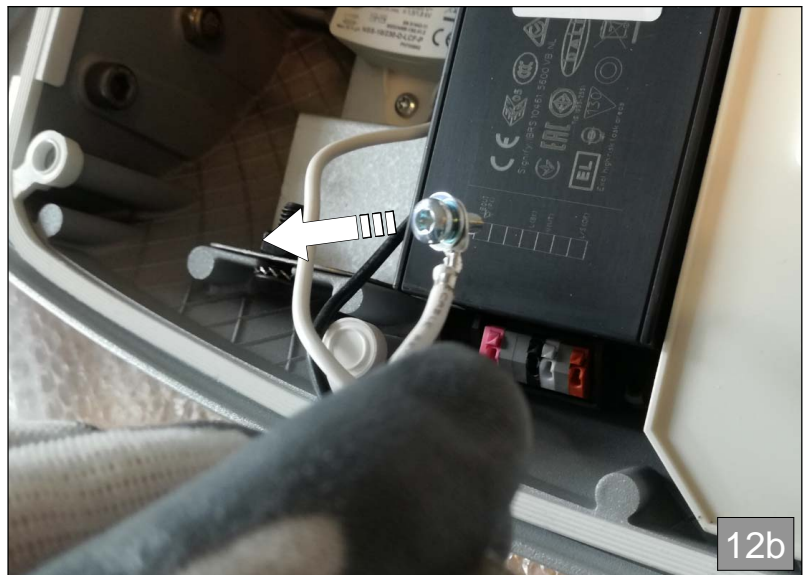
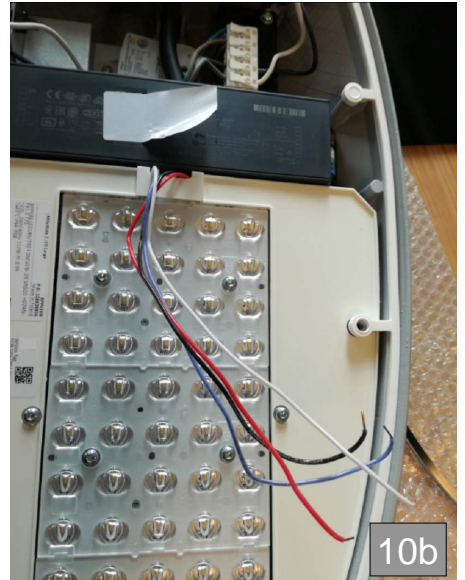

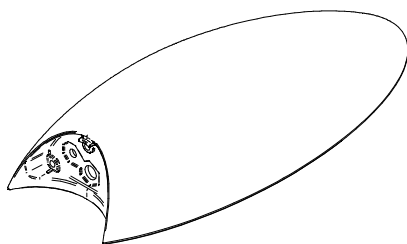
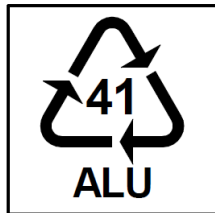
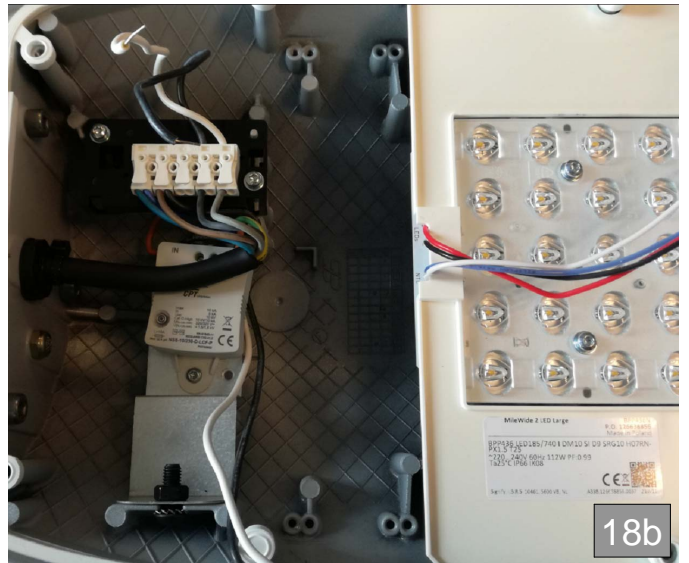
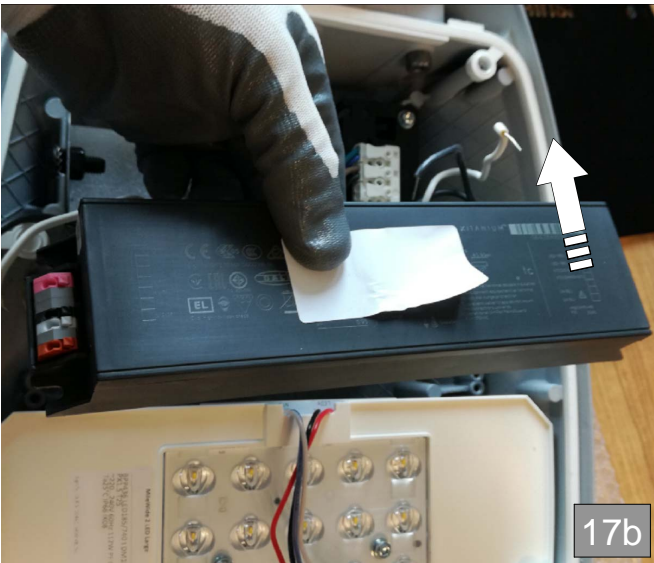

401

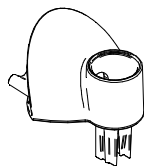

701

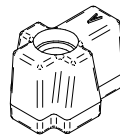

712

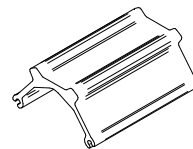

710

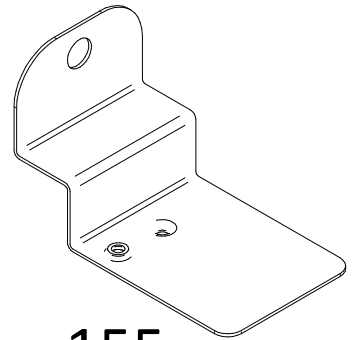
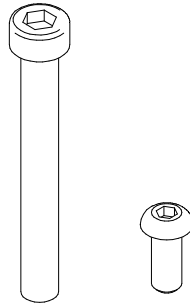
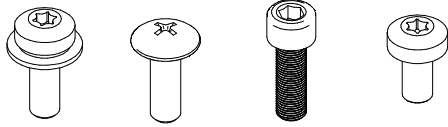
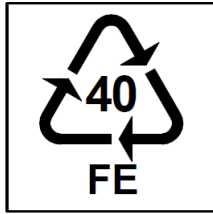

155

111, 204, 702, 185, 713, 156,

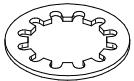

474

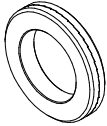

725



714

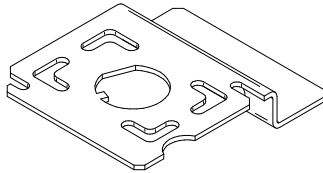

472



157

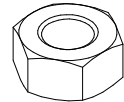

158

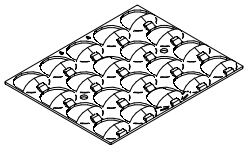
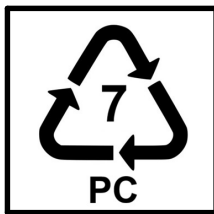

651



203

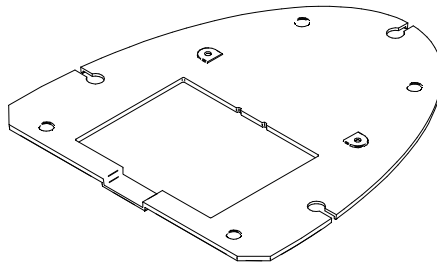

422

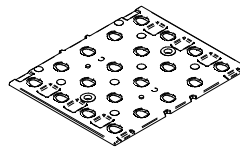
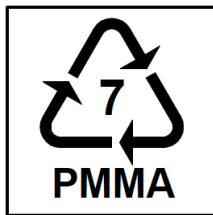

630

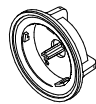
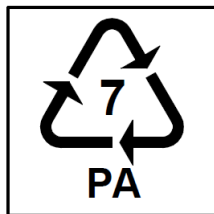

476 /
477



475

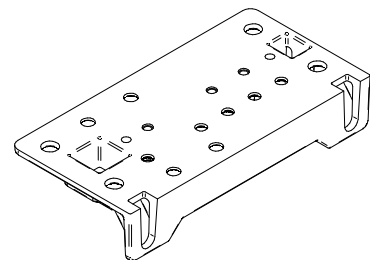

410

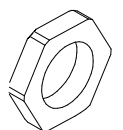

425

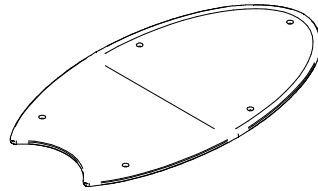
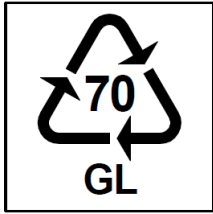

201

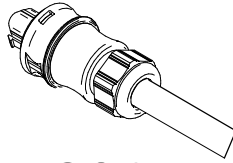
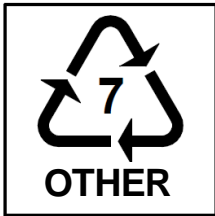

801

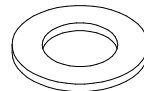

473



420

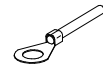

105

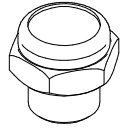

403

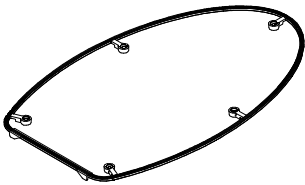

202

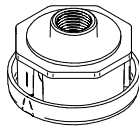

402

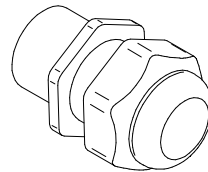

420

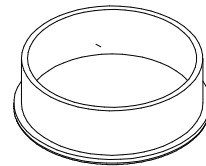

715

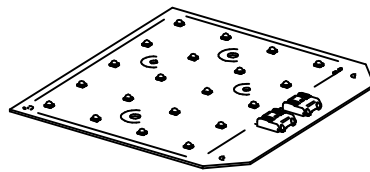

625

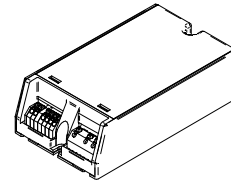

110

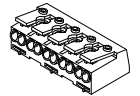

404

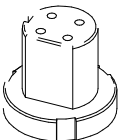

473

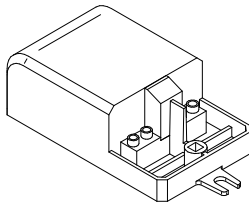

170

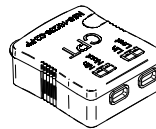

151

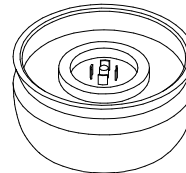

460



405

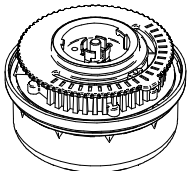

450

GB	Please inform yourself about the local waste disposal, separation and collection system for electrical and electronic products. Please act according to your local rules and do not dispose of your old product with your normal household waste. The correct disposal of your product will help prevent potential negative consequences for the environment and human health.	RO	Vă rugăm să vă informați despre sistemul local de colectare, separare și eliminare a deșeurilor pentru produsele electrice și electronice. Vă rugăm să acționați conform regulilor locale și să nu aruncați produsul vechi împreună cu deșeurile menajere obișnuite. Eliminarea corectă a produsului dumneavoastră va ajuta la prevenirea posibilelor consecințe negative asupra mediului și sănătății umane.
ES	Por favor Infórmese sobre el sistema local de eliminación, separación y recogida de residuos de productos eléctricos y electrónicos. Por favor, actúe de acuerdo con las normas locales y no deseche su producto antiguo con la basura doméstica normal. La eliminación correcta de su producto ayudará a prevenir posibles consecuencias negativas para el medio ambiente y la salud humana.	FI	Tutustu paikallisiin sähkö- ja elektroniikkatuotteiden jätehuolto- ja keräysjärjelyistä. Toimi paikallisten sääntöjen mukaan alaka hävittä tuotteita tavallisen kotitalousjätteen mukana. Tuotteen oikea hävittäminen auttaa estämään mahdolliset kielteiset vaikutukset ympäristöön ja ihmisten terveyteen.
PT	Informe-se sobre o sistema local de eliminação, separação e recolha de resíduos de produtos elétricos e eletrónicos. Por favor, aja de acordo com as regras locais e não elimine o seu produto antigo com o seu lixo doméstico normal. A correta eliminação do seu produto ajudará a prevenir potenciais consequências negativas para o ambiente e para a saúde humana.	RU	Пожалуйста, ознакомьтесь с местной системой утилизации, разделения и сбора электрических и электронных продуктов. Действуйте в соответствии с местными правилами и не выбрасывайте старый продукт вместе с обычными бытовыми отходами. Правильная утилизация вашего продукта поможет предотвратить возможные негативные последствия для окружающей среды и здоровья человека.
DE	Bitte informieren Sie sich über das örtliche Entsorgungs-, Trenn- und Sammelsystem für elektrische und elektronische Produkte. Bitte handeln Sie gemäß den örtlichen Vorschriften und entsorgen Sie Ihr altes Produkt nicht mit dem normalen Hausmüll. Die korrekte Entsorgung Ihres Produkts trägt dazu bei, mögliche negative Folgen für die Umwelt und die menschliche Gesundheit zu vermeiden.	HR	Molimo da se informirate oko lokalnih opcija ispravnog odlaganja, odvajanja i prikupljanja električnog i elektroničkog otpada. Molimo da se ponašate u skladu s lokalnom regulativom i ne odlazete ovakav stari proizvod s vašim kućnim otpadom. Ispravno postupanje sa starim proizvodom pomoći će spriječiti negativne posljedice nepravilnog postupanja na okoliš i ljudsko zdravlje.
FR	Veillez-vous renseigner sur les modalités en vigueur localement pour la mise en décharge, le tri et la collecte des produits électriques et électroniques. Veillez à vous conformer aux réglementations locales et ne pas jeter l'ancien produit avec les déchets ménagers. L'élimination de votre produit dans la filière adéquate permettra d'éviter les éventuels impacts négatifs sur l'environnement et sur la santé humaine.	GR	Παρακαλείστε να ενημερωθείτε για το τοπικό σύστημα διάθεσης, διαχωρισμού και συλλογής ηλεκτρικών και ηλεκτρονικών προϊόντων. Παρακαλούμε να ενεργείτε σύμφωνα με τους τοπικούς σας κανόνες και να μην απορρίπτετε το παλιό σας προϊόν με τα συνηθισμένα οικιακά απορρίμματα. Η σωστή απόρριψη του προϊόντος σας θα βοηθήσει στην πρόληψη πιθανών αρνητικών συνεπειών για το περιβάλλον και την ανθρώπινη υγεία.
IT	Informatevi sul sistema locale di smaltimento, separazione e raccolta dei rifiuti per prodotti elettrici ed elettronici. Si prega di agire secondo le regole locali e non smaltire il vecchio prodotto con i normali rifiuti domestici. Il corretto smaltimento del prodotto aiuterà a prevenire potenziali conseguenze negative per l'ambiente e per l'uomo.	TR	Lütfen elektrikli ve elektronik ürünler için yerel atık imha, ayrıca ve toplama sistemi hakkında bilgi edinin. Lütfen yerel kurallarınıza göre hareket edin ve eski ürününüzü normal ev atığınızla birlikte atmayın. Ürününüzün doğru şekilde imha edilmesi, çevre ve insan sağlığı için olası olumsuz sonuçları önlemeye yardımcı olacaktır.
NL	Informeer uzelf over het lokale afvalverwijderings-, -scheidings en -inzamelingsstelsel voor elektrische en elektronische producten. Volg de lokale voorschriften en gooi uw oude product niet weg met uw normale huishoudafval. Een correcte afvalverwijdering van uw product helpt eventuele negatieve gevolgen voor het milieu en de menselijke gezondheid te voorkomen.	BG	Моля, информирайте се за местната система за изхвърляне, разделяне и събиране на отпадъци за електрически и електронни продукти. Моля, действайте в съответствие с местните правила и не изхвърляйте излезлия си от употреба стар продукт с обичайните си битови отпадъци. Правилното изхвърляне на вашия продукт ще помогне за предотвратяване на потенциални негативни последици за околната среда и човешкото здраве.
DK	Venligst sæt Dem ind i gældende affaldshåndtering, sortering og indsamlings ordninger for elektronik. Venligst følg lokale regler og bortskaft ikke dit gamle produkt sammen med dit normale husholdningsaffald. Korrekt bortskaftelse af dit produkt hjælper med at forhindre potentielle negative konsekvenser for miljøet og menneskers sundhed.	SK	Prosím informujte sa lokálnom systéme likvidácie, separácia a zberu odpadu elektrických a elektronických zariadení. Prosím postupujte v súlade s lokálnymi predpismi a nevyhadzujte svoj starý výrobok do bežného komunálneho odpadu. Správna likvidácia vášho výrobku pomôže predísť potenciálnym negatívnym dopadom na životné prostredie a zdravie ľudí.
SE	Vi ber er att hålla er informerade om den lokala avfallshanteringen, samt sortering och insamlingsssystem för elektriska och elektroniska produkter. Följ de lokala reglerna och släng inte din gamla produkt bland ditt vanliga hushållsavfall. Korrekt avfallshandtering hjälper till att förhindra negativ inverkan på miljön och människors hälsa.	LT	Prašome pasidomėti apie jūsų šalies veikiančią elektrinių ir elektroninių gaminių atliekų šalinimo, atskirimo ir surinkimo sistemą. Elkitės vadovaudamiesi vietinėmis taisyklėmis ir neišmeskite seno gaminio su įprastomis buitinėmis atliekomis. Teisingas produkto pašalinimas padės išvengti galimų neigiamų pasekmių aplinkai ir žmonių sveikatai.
NO	Oppdater deg på de lokale regler for håndtering, sortering og innsamling av elektrisk og elektronisk avfall. Følg de lokale reglene og kast ikke det gamle produktet i vanlig husholdningsavfall. Riktig håndtering av ditt produkt vil forhindre potensielle negative konsekvenser for miljøet og folks helse.	LV	Lūgums, iepazīties ar vietējiem elektrisko un elektronisko izstrādājumu atkritumu iznīcināšanas, atdalīšanas un savākšanas noteikumiem. Lūdzu, rīkojieties saskaņā ar vietējiem noteikumiem un neizmetiet veco izstrādājumu kopā ar parastajiem sadzīves atkritumiem. Pareiza produkta iznīcināšana palīdzēs novērst iespējamās negatīvās sekas videi un cilvēku veselībai.
CZ	Informujte se o způsobu likvidace, třídění a sběru elektrických a elektronických výrobků. Postupujte podle místních předpisů a nelikvidujte starý výrobek s běžným domácím odpadem. Správná likvidace Vašeho produktu pomůže předcházet možným negativním dopadům na životní prostředí a lidské zdraví.	EE	Palun viige ennast kurssi kohaliku elektril- ja elektroonikatoodete jäätmete kõrvaldamise, eraldamise ja kogumise süsteemiga. Palun loimige vastavalt kohalikele eeskirjadele ja ärge visake oma vana toodet tavalisste olmejäätmete hulka. Teie toote õige kõrvaldamine aitab ära hoida võimalikke negatiivseid tagajärgi keskkonnale ja inimeste tervisele.
HU	Kérjük, tájékozódjon az Ön országában érvényes elektronikai hulladék ártalmatlanítási, élkülönítési és gyűjtési rendszerével kapcsolatban. Kérjük, tartsa be a vonatkozó előírásokat és jogszályokat, régi termékét ne dobja a kommunális hulladék közé. A termék megfelelő ártalmatlanítása segít elkerülni a környezetre és az emberi egészségre gyakorolt negatív hatásokat.	SI	Prosimo, seznanite se z lokalnim sistemom za odstranjevanje, ločevanje in zbiranje odpadkov za električne izdelke. Upoštevajte lokalna pravila in izdelka ne odvrzite skupaj z običajnimi gospodinjstskimi odpadki. Pravilno odstranjevanje izdelka bo pomagalo preprečiti morebitne negativne posledice za okolje in zdravje ljudi.
PL	Prosimy o zapoznanie się z lokalnym systemem utylizacji, segregacji i zbiórki produktów elektrycznych i elektronicznych. Postępuj zgodnie z lokalnymi przepisami i nie wyrzucaj starego produktu razem ze zwykłymi odpadami domowymi. Prawidłowa utylizacja produktu pomoże zapobiec potencjalnym negatywnym konsekwencjom dla środowiska i zdrowia ludzi.		

- GB The light source and/or control gear and/or the external flexible cable contained in this luminaire shall only be replaced by the manufacturer or his service agent or a similar qualified person.
- ES La fuente de luz/o el driver / o el cable flexible contenido en la luminaria solo podrá ser sustituido por el fabricante o su agente de servicio o por una persona cualificada.
- PT A fonte de luz e/ou o equipamento de controlo e/ou o cabo externo flexível nesta luminária só devem ser substituídos pelo fabricante ou pelo seu agente de serviço ou por pessoa qualificada para tal.
- DE Die in dieser Leuchte enthaltene Lichtquelle und/oder das Betriebsgerät und/oder das externe flexible Anschlusskabel darf nur vom Hersteller oder seinem Kundendienst oder einer ähnlich qualifizierten Person ausgetauscht werden.
- FR La source lumineuse et/ou le contrôleur de courant et/ou le câble souple d'alimentation contenus dans ce luminaire ne doivent être remplacés que par le fabricant, un de ses agents ou une personne qualifiée.
- IT La sorgente luminosa e/o il dispositivo di controllo e/o il cavo flessibile esterno contenuti in questo apparecchio di illuminazione sono sostituiti solo dal costruttore o dal suo agente di servizio o da una persona qualificata analoga.
- NL De lichtbron en/of voorschakelapparatuur en/of de flexibele voedingskabel van dit armatuur mag alleen vervangen worden door de fabrikant of haar service dealer of een vergelijkbaar gekwalificeerd persoon.
- DK Lyskilden og/eller driver og/eller eksterne kabler indeholdt i dette armatur må kun udskiftes af producenten eller godkendt service partner eller lignende kvalificeret person.
- SE Ljuskällan och/eller styrsystemet och/eller den externa kabeln i denna armatur får endast bytas ut av tillverkaren eller en kvalificerad person.
- NO Lyskilden og/eller driveren og/eller den eksterne kabelen i dette armaturet skal bare erstattes av produsenten eller dens service agent eller tilsvarende kvalifisert person.
- CZ Světelný zdroj a/nebo napájecí zdroj (předřadník) a/nebo flexibilní napájecí kabel v tomto svítidle smí vyměňovat pouze výrobce nebo jeho servisní technik nebo obdobně kvalifikovaná osoba.
- HU A lámpatestben található fényforrást és/vagy működtető szerelvény és/vagy a külső rugalmas kábelt csak a gyártó, a gyártóval szerződött cég vagy megfelelő képesítéssel rendelkező szakember cserélheti ki.
- PL Źródło światła i/lub zasilacz i/lub zewnętrzny przewód zasilający, który jest w sprawie powinien być wymieniony przez producenta lub jego serwisanta lub kwalifikowany personel.
- RO Sursa de lumină și / sau aparatură și / sau cablu flexibil extern conținut în acest aparat de iluminat trebuie înlocuite numai de producător sau de agentul său de service sau de o persoană calificată similară.
- FI Tässä valaisimessa oleva valonlähde ja/tai muut komponentit, kuten liitäntälaitte ja/tai ulkoiset kaapelit saadaan vaihtaa vain valmistajan tai tämän valtuuttaman huoltoedustajan tai vastaavan pätevän henkilön toimesta.
- TR Bu armatürde bulunan ışık kaynağı ve / veya kontrol tertibatı ve / veya harici esnek kablo, yalnızca imalatçı veya onun servis temsilcisi veya benzer bir kalifiye kişi tarafından değiştirilmelidir.
- HR Izvor svjetlosti i / ili predspojna naprava i / ili vanjski fleksibilni napojni kabel sadržan u ovoj svjetiljci smije zamijeniti samo proizvođač, ovlašteni serviser ili adekvatna stručno osposobljena i ovlaštena osoba.
- GR Η φωτεινή πηγή ή/και τα όργανα έναυσης/ελέγχου ή/και το εξωτερικό εύκαμπτο καλώδιο που περιέχεται στο εν λόγω φωτιστικό πρέπει να αντικαθίστανται μόνο από τον κατασκευαστή ή τον αντιπρόσωπο σέρβις ή παρόμοιο ειδικευμένο πρόσωπο.
- BG Източникът на светлина и / или пусково-регулируща апаратура и / или външният гъвкав кабел, съдържащ се в това осветително тяло, трябва да бъдат заменени само от производителя или неговия оторизиран сервиз или подобно квалифицирано лице.
- RU Источник света и / или ПРА и / или внешний гибкий кабель, содержащиеся в этом светильнике, могут быть заменены только производителем, его агентом по обслуживанию или аналогичным квалифицированным лицом.
- SK Svetelný zdroj a/alebo predradník a/alebo externý flexibilný kábel obsiahnutý v tomto svietidle môže byť vymenený len výrobcom alebo servisným partnerom alebo inou podobne kvalifikovanou osobou.
- LT Šviesos šaltinis ir/arba valdymo įrenginys ir/arba išorinis lankstus kabelis esantis šiame šviestuve gali būti pakeistas tik gamintojo arba jo aptarnavimo agento ar tai atitinkancio kvalifikuoto asmens.
- LV Gaismas avotu un / vai vadības ierīci un / vai ārējo elastīgo kabeli, kas atrodas šajā gaismeklī, drīkst nomainīt tikai ražotājs vai viņa servisa pārstāvis vai līdzīga kvalificēta persona.
- EE Selles valgustus sisalduva valgusallika ja/või juhtimiseseadme ja/või välise painduva kaabli võib välja vahetada ainult tootja, vastav hooldusspetsialist või muu sarnane kvalifitseeritud isik.
- SI Vir svetlobe in / ali napajalnik in / ali zunanji prilagodljivi kabel, ki ga vsebuje ta svetilka, lahko zamenja le proizvajalec ali njegov servis ali podobna usposobljena oseba.



© 2021-2026 Signify Holding

All rights reserved. The information provided herein is subject to change, without notice. Signify does not give any representation or warranty as to the accuracy or completeness of the information included herein and shall not be liable for any action in reliance thereon. The information presented in this document is not intended as any commercial offer and does not form part of any quotation or contract, unless otherwise agreed by Signify. All trademarks are owned by Signify Holding or their respective owners.

Signify Holding
The Netherlands