



FlexBlend baant de weg voor efficiënte en flexibel ingerichte kantoorruimten

FlexBlend, pendelmontage

Philips FlexBlend is een aantrekkelijk assortiment armaturen voor opbouw- en pendelmontage naast FlexBlend voor inbouwmontage. De armatuurserie geeft eigenaars van gebouwen de mogelijkheid om de prestaties van hun verlichting te moderniseren door verlichting aan te bieden die voldoet aan alle kantoonormen, met een terugverdientijd van minder dan 3 tot 4 jaar. FlexBlend biedt de benodigde flexibiliteit doordat het ontwerp zeer aanpasbaar is. Dit maakt het mogelijk om de armaturen eenvoudig op elk moment ter plaatse te installeren. Zelfs als de huidige armatuur een hangende armatuur is, kan deze morgen op locatie worden vervangen door een installatie met opbouwmontage – of andersom. . De series armaturen voor opbouwmontage en pendelmontage passen in diverse kantoorruimten zoals kantoorruimten, gangen, de receptie of vergaderruimten. FlexBlend wordt aangeboden als lichtlijn en als opzichzelfstaande armatuur, beide met dezelfde verlichtingsmodule. Dit geeft gebruikers de optie om FlexBlend vandaag als afzonderlijke armatuur en in de toekomst als lichtlijn te gebruiken. De regelaar is ingebouwd in de armatuur. Doordat technologie snel evolueert, wordt ook van de ideale lichtoplossing verwacht dat deze in staat is om innovaties en toekomstige ontwikkelingen te integreren die de prestaties nog verder kunnen helpen verbeteren. Daarom beschikt FlexBlend over alle opties voor connectiviteit en toekomstbestendige technologie. De armatuur is System Ready en kan worden gekoppeld met verlichtingsbeheersystemen zoals Philips SpaceWise, met softwaregebaseerde verlichtingssysteem zoals Interact Office (zowel bedraad (PoE) als draadloos) en/of met bestaande en toekomstige sensorinnovaties. Het assortiment armaturen is helemaal klaar voor de toekomst en kan zonder systeemcomponenten worden geleverd om later ter plaatse te worden geüpgraded: een mooie gelegenheid voor zowel nieuwe installaties als renovaties.

FlexBlend, pendelmontage

Voordelen

- Terugverdientijd van minder dan 3 jaar
- Een flexibel kantoor, met toepassingsflexibiliteit dankzij de keuze uit armaturen die bij tal van kantoorruimten passen
- Klaar voor de toekomst: schaalbaar en geschikt voor aansluiting op bedienings- en verlichtingssystemen

Kenmerken

- Voldoet volledig aan kantoonormen (UGR <19, L65< 3000 cd/sm) , lichtniveau volgens vereisten voor kantoor toepassingen
- Homogeen en gelijkmatig lichteffect
- Verschillende montageopties, diverse maten en lokale opties
- Geïntegreerde sensors
- Klaar om te worden verbonden met op software gebaseerde verlichtingssystemen zoals Interact Office

Toepassing

- Kantoren
- Onderwijs
- Gezondheidszorg

Waarschuwingen en veiligheid

- Dit product is geclassificeerd als IPX0 en biedt geen bescherming tegen het binnendringen van water. Daarom raden we nadrukkelijk aan om de omgeving waarin de armatuur wordt geïnstalleerd, voldoende te controleren.
- Als het bovenstaande advies niet in acht wordt genomen en de armaturen worden blootgesteld aan binnendringend water, kan Philips/Signify niet garanderen dat de armatuur veilig wordt uitgeschakeld en vervalt de productgarantie.

Versions



FlexBlend Suspended SP340P O
WH



FlexBlend Suspended SP340P PCS
BK



FlexBlend Suspended-SM340C-
MLO-WH-SENS1-L150

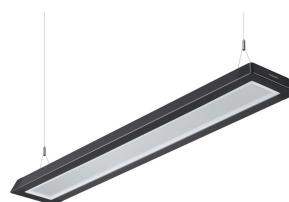

FlexBlend Suspended SP340P
MLO BK

FlexBlend, pendelmontage

Versions



FlexBlend Suspended SP340P PCS
SI



FlexBlend Suspended SP340P
MLO SI

Maatschets

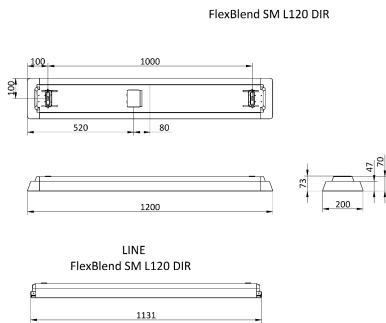
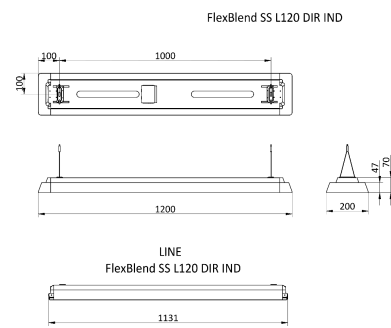
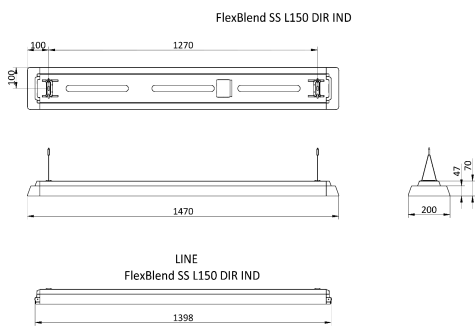

Productgegevens



FlexBlend Suspended SP340P WH



FlexBlend Suspended SP340P

FlexBlend, pendelmontage

Productgegevens



FlexBlend Suspended SP340P O
BK

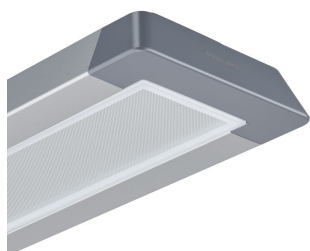

FlexBlend Suspended SP340P
MLO SI

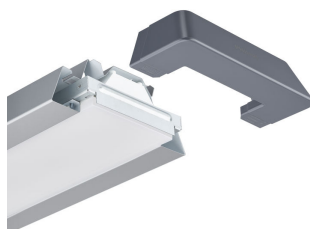

FlexBlend Suspended SP340P O SI



FlexBlend Suspended SP340P PCS
BK



FlexBlend Suspended SP340P SI



FlexBlend Suspended SP340P PCS
WH

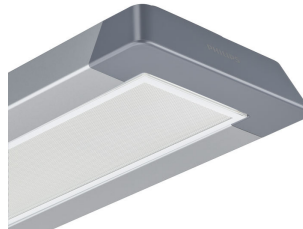

FlexBlend Suspended SP340P PCS
SI



FlexBlend Suspended SP340P SI

FlexBlend, pendelmontage

Productgegevens

FlexBlend Suspended SP340P WH

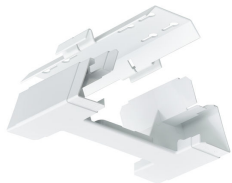

FlexBlend Suspended SP340P BK



FlexBlend_Suspended_SP340P-
line-MLO-WH-SWZU

FlexBlend Suspended SP340P
MLO BK

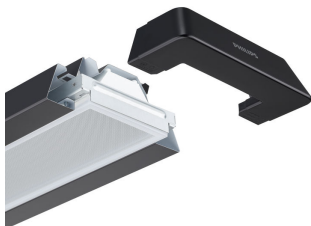

FlexBlend Suspended SP340P
MLO BK

FlexBlend Suspended SP340P BK



FlexBlend Suspended SP340P
MLO SI

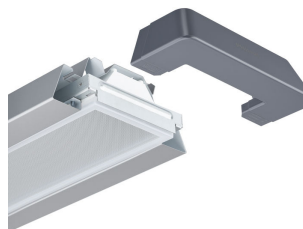

FlexBlend, pendelmontage

Productgegevens



FlexBlend Surface Mounted
SM340C



FlexBlend Suspended SP340P O
WH



FlexBlend Suspended SP340P
MLO WH



FlexBlend Suspended SP340P SI

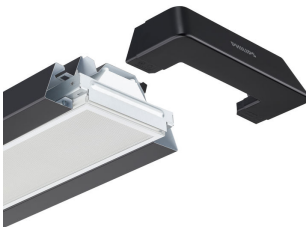

FlexBlend Suspended SP340P PCS
BK



FlexBlend Suspended SP340P BK

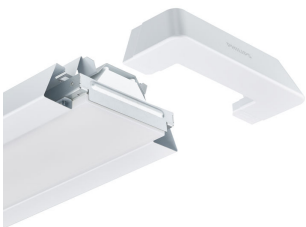

FlexBlend Suspended SP340P O
WH



FlexBlend Suspended SP340P WH

FlexBlend, pendelmontage

Productgegevens



FlexBlend Suspended SP340P WH

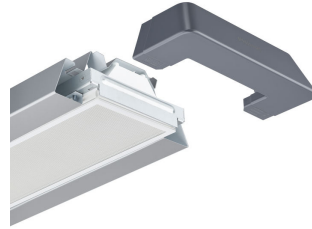

FlexBlend Suspended SP340P PCS
SI



FlexBlend Suspended SP340P WH

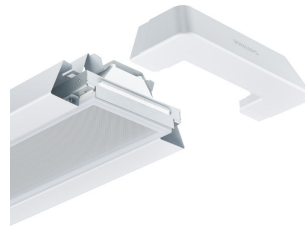

FlexBlend Suspended SP340P
MLO WH



FlexBlend Suspended SP340P BK



FlexBlend Suspended SP340P SI



FlexBlend Suspended SP340P BK

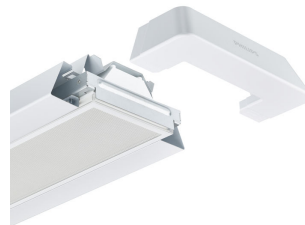

FlexBlend Suspended SP340P PCS
WH

FlexBlend, pendelmontage

Productgegevens

FlexBlend Suspended SP340P SI

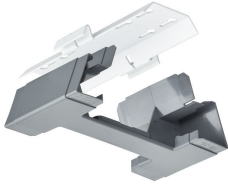

FlexBlend Suspended SP340P O
BK

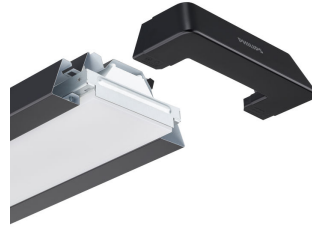

Algemene informatie

Driver/VSA inbegrepen	Ja
Lichtbron vervangbaar	Nee
Aantal VSA's	1 unit
Servicetag	Ja

Gegevens lichttechniek

Kleurweergave-index (CRI)	>90
Optiektype	Brede bundel

Bedrijfs- en elektrische gegevens

IEC beschermingsklasse	Veiligheidsklasse I
Ingangsspanning	220 tot 240 V
Ingangsfrequentie	50 to 60 Hz

Dimbaarheid en regelsystemen

Dimbaar	Ja
Maximaal dimniveau	1%

Eigenschappen behuizing en afmetingen

IK-classificatie	IK02
Beschermingsklasse	IP 20

Keurmerken en classificaties

Bereik omgevingstemperatuur	+10 tot +40 °C
CE-markering	Ja
Brandbaarheidsmarkering	Voor montage op normaal brandbare oppervlakken
Flikkerwaarde (PstLM)	1
Stroboscoopeffectwaarde (SVM)	0,4

Initiële prestaties (conform IEC)

Tolerantie lichtstroom	+/-10%
------------------------	--------

Gegevens lichttechniek

Order Code	Full Product Name	Bundelhoek lichtbron	Gecorreleerde			Lichtstroom
			kleurtemperatuur (nom.)	Lichtrendement (gespec.) (nom.)		
8719514103788	SP342P 45S/940 DEIA O SMT L150 WH	120 graden	4000 K	136 lm/W	4.500 lm	
8719514103672	SP342P 45S/940 DEIA PCS SMT L150 BK	120 graden	4000 K	145 lm/W	4.500 lm	
8719514103658	SP342P 45S/940 DEIA PCS SMT L150 WH	120 graden	4000 K	145 lm/W	4.500 lm	
8719514103870	SP340P 36S/940 DEIA PCS SMT L120 WH	120 graden	4000 K	138 lm/W	3.600 lm	
8719514103887	SP340P 42S/940 DEIA PCS SMT L120 WH	120 graden	4000 K	143 lm/W	4.200 lm	
8719514103917	SP342P 48S/940 DEIA PCS SMT L120 WH	120 graden	4000 K	141 lm/W	4.800 lm	
8719514708082	SP340P 42S/940 SEIA PCS U4 SMT L120 WH	- graden	4000 K	143 lm/W	4.200 lm	
8719514708099	SP342P 45S/930 SEIA MLO U4 SMT L150 WH	- graden	3000 K	110 lm/W	4.500 lm	
8719514708198	SP340P 40S/940 SEIA MLO U4 SMT L120 WH	- graden	4000 K	96 lm/W	4.000 lm	
8719514708204	SP340P 36S/940 SEIA PCS U4 SMT L120 WH	- graden	4000 K	138 lm/W	3.600 lm	
8719514708211	SP340P 36S/940 SEIA MLO U4 SMT L120 WH	- graden	4000 K	97 lm/W	3.600 lm	

Order Code	Full Product Name	Bundelhoek lichtbron	Gecorreleerde		Lichtstroom
			kleurtemperatuur (nom.)	Lichtrendement (gespec.) (nom.)	
8719514103757	SP342P 45S/940 DEIA MLO SMT L150 BK	120 graden	4000 K	112 lm/W	4.500 lm
8719514103665	SP342P 45S/940 DEIA PCS SMT L150 SI	120 graden	4000 K	145 lm/W	4.500 lm
8719514103740	SP342P 45S/940 DEIA MLO SMT L150 SI	120 graden	4000 K	112 lm/W	4.500 lm
8719514103733	SP342P 45S/940 DEIA MLO SMT L150 WH	120 graden	4000 K	112 lm/W	4.500 lm
8719514103894	SP340P 36S/940 DEIA MLO SMT L120 WH	120 graden	4000 K	95 lm/W	3.600 lm
8719514103900	SP340P 40S/940 DEIA MLO SMT L120 WH	120 graden	4000 K	94 lm/W	4.000 lm
8719514103931	SP342P 48S/940 DEIA MLO SMT L120 WH	120 graden	4000 K	109 lm/W	4.800 lm
8719514103948	SP342P 52S/940 DEIA MLO SMT L120 WH	120 graden	4000 K	108 lm/W	5.200 lm

Bedrijfs- en elektrische gegevens

Order Code	Full Product Name	Energieverbruik	Geschikt voor willekeurige schakeling	Order Code	Full Product Name	Energieverbruik	Geschikt voor willekeurige schakeling
8719514103788	SP342P 45S/940 DEIA O SMT L150 WH	37,5 W	Ja (gerelateerd aan gedetecteerde aanwezigheid/beweging en de hoeveelheid daglicht)	8719514103917	SP342P 48S/940 DEIA PCS SMT L120 WH	36 W	Ja (gerelateerd aan gedetecteerde aanwezigheid/beweging en de hoeveelheid daglicht)
8719514103672	SP342P 45S/940 DEIA PCS SMT L150 BK	35 W	Ja (gerelateerd aan gedetecteerde aanwezigheid/beweging en de hoeveelheid daglicht)	8719514708082	SP340P 42S/940 SEIA PCS U4 SMT L120 WH	27 W	Nee
8719514103658	SP342P 45S/940 DEIA PCS SMT L150 WH	35 W	Ja (gerelateerd aan gedetecteerde aanwezigheid/beweging en de hoeveelheid daglicht)	8719514708099	SP342P 45S/930 SEIA MLO U4 SMT L150 WH	44,5 W	Nee
8719514103870	SP340P 36S/940 DEIA PCS SMT L120 WH	26,5 W	Ja (gerelateerd aan gedetecteerde aanwezigheid/beweging en de hoeveelheid daglicht)	8719514708198	SP340P 40S/940 SEIA MLO U4 SMT L120 WH	38,5 W	Nee
8719514103887	SP340P 42S/940 DEIA PCS SMT L120 WH	32 W	Ja (gerelateerd aan gedetecteerde aanwezigheid/beweging en de hoeveelheid daglicht)	8719514708204	SP340P 36S/940 SEIA PCS U4 SMT L120 WH	26 W	Nee
				8719514708211	SP340P 36S/940 SEIA MLO U4 SMT L120 WH	32,5 W	Nee
				8719514103757	SP342P 45S/940 DEIA MLO SMT L150 BK	42,5 W	Ja (gerelateerd aan gedetecteerde aanwezigheid/beweging en de hoeveelheid daglicht)
				8719514103665	SP342P 45S/940 DEIA PCS SMT L150 SI	35 W	Ja (gerelateerd aan gedetecteerde

FlexBlend, pendelmontage

Order Code	Full Product Name	Energieverbruik	Geschikt voor willekeurige schakeling
			aanwezigheid/beweging en de hoeveelheid daglicht)
8719514103740	SP342P 45S/940 DEIA MLO SMT L150 SI	42,5 W	Ja (gerelateerd aan gedetecteerde aanwezigheid/beweging en de hoeveelheid daglicht)
8719514103733	SP342P 45S/940 DEIA MLO SMT L150 WH	42,5 W	Ja (gerelateerd aan gedetecteerde aanwezigheid/beweging en de hoeveelheid daglicht)
8719514103894	SP340P 36S/940 DEIA MLO SMT L120 WH	35 W	Ja (gerelateerd aan gedetecteerde aanwezigheid/beweging en de hoeveelheid daglicht)

Order Code	Full Product Name	Energieverbruik	Geschikt voor willekeurige schakeling
			aanwezigheid/beweging en de hoeveelheid daglicht)
8719514103900	SP340P 40S/940 DEIA MLO SMT L120 WH	39 W	Ja (gerelateerd aan gedetecteerde aanwezigheid/beweging en de hoeveelheid daglicht)
8719514103931	SP342P 48S/940 DEIA MLO SMT L120 WH	44,5 W	Ja (gerelateerd aan gedetecteerde aanwezigheid/beweging en de hoeveelheid daglicht)
8719514103948	SP342P 52S/940 DEIA MLO SMT L120 WH	48,5 W	Ja (gerelateerd aan gedetecteerde aanwezigheid/beweging en de hoeveelheid daglicht)

Dimbaarheid en regelsystemen

Order Code	Full Product Name	Ingebouwde regeling
8719514103788	SP342P 45S/940 DEIA O SMT L150 WH	-
8719514103672	SP342P 45S/940 DEIA PCS SMT L150 BK	-
8719514103658	SP342P 45S/940 DEIA PCS SMT L150 WH	-
8719514103870	SP340P 36S/940 DEIA PCS SMT L120 WH	-
8719514103887	SP340P 42S/940 DEIA PCS SMT L120 WH	-
8719514103917	SP342P 48S/940 DEIA PCS SMT L120 WH	-
8719514708082	SP340P 42S/940 SEIA PCS U4 SMT L120 WH	Upgradebare sensoraansluiting met SC200-sensor
8719514708099	SP342P 45S/930 SEIA MLO U4 SMT L150 WH	Upgradebare sensoraansluiting met SC200-sensor
8719514708198	SP340P 40S/940 SEIA MLO U4 SMT L120 WH	Upgradebare sensoraansluiting met SC200-sensor

Order Code	Full Product Name	Ingebouwde regeling
8719514708204	SP340P 36S/940 SEIA PCS U4 SMT L120 WH	Upgradebare sensoraansluiting met SC200-sensor
8719514708211	SP340P 36S/940 SEIA MLO U4 SMT L120 WH	Upgradebare sensoraansluiting met SC200-sensor
8719514103757	SP342P 45S/940 DEIA MLO SMT L150 BK	-
8719514103665	SP342P 45S/940 DEIA PCS SMT L150 SI	-
8719514103740	SP342P 45S/940 DEIA MLO SMT L150 SI	-
8719514103733	SP342P 45S/940 DEIA MLO SMT L150 WH	-
8719514103894	SP340P 36S/940 DEIA MLO SMT L120 WH	-
8719514103900	SP340P 40S/940 DEIA MLO SMT L120 WH	-
8719514103931	SP342P 48S/940 DEIA MLO SMT L120 WH	-
8719514103948	SP342P 52S/940 DEIA MLO SMT L120 WH	-

Eigenschappen behuizing en afmetingen

Order Code	Full Product Name	Kleur behuizing
8719514103788	SP342P 45S/940 DEIA O SMT L150 WH	Wit
8719514103672	SP342P 45S/940 DEIA PCS SMT L150 BK	Zwart
8719514103658	SP342P 45S/940 DEIA PCS SMT L150 WH	Wit
8719514103870	SP340P 36S/940 DEIA PCS SMT L120 WH	Wit
8719514103887	SP340P 42S/940 DEIA PCS SMT L120 WH	Wit
8719514103917	SP342P 48S/940 DEIA PCS SMT L120 WH	Wit
8719514708082	SP340P 42S/940 SEIA PCS U4 SMT L120 WH	Wit
8719514708099	SP342P 45S/930 SEIA MLO U4 SMT L150 WH	Wit
8719514708198	SP340P 40S/940 SEIA MLO U4 SMT L120 WH	Wit
8719514708204	SP340P 36S/940 SEIA PCS U4 SMT L120 WH	Wit

Order Code	Full Product Name	Kleur behuizing
8719514708211	SP340P 36S/940 SEIA MLO U4 SMT L120 WH	Wit
8719514103757	SP342P 45S/940 DEIA MLO SMT L150 BK	Zwart
8719514103665	SP342P 45S/940 DEIA PCS SMT L150 SI	Zilver
8719514103740	SP342P 45S/940 DEIA MLO SMT L150 SI	Zilver
8719514103733	SP342P 45S/940 DEIA MLO SMT L150 WH	Wit
8719514103894	SP340P 36S/940 DEIA MLO SMT L120 WH	Wit
8719514103900	SP340P 40S/940 DEIA MLO SMT L120 WH	Wit
8719514103931	SP342P 48S/940 DEIA MLO SMT L120 WH	Wit
8719514103948	SP342P 52S/940 DEIA MLO SMT L120 WH	Wit

Keurmerken en classificaties

FlexBlend, pendelmontage

Order Code	Full Product Name	ENEC-markering	Gloeidraadtest
8719514103788	SP342P 45S/940 DEIA O SMT L150 WH	ENEC- plusmarkering	Temperatuur 850 °C, duur 30 s
8719514103672	SP342P 45S/940 DEIA PCS SMT L150 BK	ENEC- plusmarkering	Temperatuur 850 °C, duur 30 s
8719514103658	SP342P 45S/940 DEIA PCS SMT L150 WH	ENEC- plusmarkering	Temperatuur 850 °C, duur 30 s
8719514103870	SP340P 36S/940 DEIA PCS SMT L120 WH	ENEC- plusmarkering	Temperatuur 850 °C, duur 30 s
8719514103887	SP340P 42S/940 DEIA PCS SMT L120 WH	ENEC- plusmarkering	Temperatuur 850 °C, duur 30 s
8719514103917	SP342P 48S/940 DEIA PCS SMT L120 WH	ENEC- plusmarkering	Temperatuur 850 °C, duur 30 s
8719514708082	SP340P 42S/940 SEIA PCS U4 SMT L120 WH	ENEC-markering	Temperatuur 850 °C, duur 30 s
8719514708099	SP342P 45S/930 SEIA MLO U4 SMT L150 WH	ENEC-markering	Temperatuur 650 °C, duur 30 s
8719514708198	SP340P 40S/940 SEIA MLO U4 SMT L120 WH	ENEC-markering	Temperatuur 650 °C, duur 30 s
8719514708204	SP340P 36S/940 SEIA PCS U4 SMT L120 WH	ENEC-markering	Temperatuur 850 °C, duur 30 s

Order Code	Full Product Name	ENEC-markering	Gloeidraadtest
8719514708211	SP340P 36S/940 SEIA MLO U4 SMT L120 WH	ENEC-markering	Temperatuur 650 °C, duur 30 s
8719514103757	SP342P 45S/940 DEIA MLO SMT L150 BK	ENEC- plusmarkering	Temperatuur 650 °C, duur 30 s
8719514103665	SP342P 45S/940 DEIA PCS SMT L150 SI	ENEC- plusmarkering	Temperatuur 850 °C, duur 30 s
8719514103740	SP342P 45S/940 DEIA MLO SMT L150 SI	ENEC- plusmarkering	Temperatuur 650 °C, duur 30 s
8719514103733	SP342P 45S/940 DEIA MLO SMT L150 WH	ENEC- plusmarkering	Temperatuur 650 °C, duur 30 s
8719514103894	SP340P 36S/940 DEIA MLO SMT L120 WH	ENEC- plusmarkering	Temperatuur 650 °C, duur 30 s
8719514103900	SP340P 40S/940 DEIA MLO SMT L120 WH	ENEC- plusmarkering	Temperatuur 650 °C, duur 30 s
8719514103931	SP342P 48S/940 DEIA MLO SMT L120 WH	ENEC- plusmarkering	Temperatuur 650 °C, duur 30 s
8719514103948	SP342P 52S/940 DEIA MLO SMT L120 WH	ENEC- plusmarkering	Temperatuur 650 °C, duur 30 s

Initiële prestaties (conform IEC)

Order Code	Full Product Name	Aanvankelijke kleurkwaliteit
8719514103788	SP342P 45S/940 DEIA O SMT L150 WH	(0.38, 0.38) SDCM <3
8719514103672	SP342P 45S/940 DEIA PCS SMT L150 BK	(0.38, 0.38) SDCM <3
8719514103658	SP342P 45S/940 DEIA PCS SMT L150 WH	(0.38, 0.38) SDCM <3
8719514103870	SP340P 36S/940 DEIA PCS SMT L120 WH	(0.38, 0.38) SDCM <3
8719514103887	SP340P 42S/940 DEIA PCS SMT L120 WH	(0.38, 0.38) SDCM <3
8719514103917	SP342P 48S/940 DEIA PCS SMT L120 WH	(0.38, 0.38) SDCM <3
8719514708082	SP340P 42S/940 SEIA PCS U4 SMT L120 WH	0.38,0.37
8719514708099	SP342P 45S/930 SEIA MLO U4 SMT L150 WH	0.43,0.39
8719514708198	SP340P 40S/940 SEIA MLO U4 SMT L120 WH	0.38,0.37
8719514708204	SP340P 36S/940 SEIA PCS U4 SMT L120 WH	0.38,0.37

Order Code	Full Product Name	Aanvankelijke kleurkwaliteit
8719514708211	SP340P 36S/940 SEIA MLO U4 SMT L120 WH	0.38,0.37
8719514103757	SP342P 45S/940 DEIA MLO SMT L150 BK	(0.38, 0.38) SDCM <3
8719514103665	SP342P 45S/940 DEIA PCS SMT L150 SI	(0.38, 0.38) SDCM <3
8719514103740	SP342P 45S/940 DEIA MLO SMT L150 SI	(0.38, 0.38) SDCM <3
8719514103733	SP342P 45S/940 DEIA MLO SMT L150 WH	(0.38, 0.38) SDCM <3
8719514103894	SP340P 36S/940 DEIA MLO SMT L120 WH	(0.38, 0.38) SDCM <3
8719514103900	SP340P 40S/940 DEIA MLO SMT L120 WH	(0.38, 0.38) SDCM <3
8719514103931	SP342P 48S/940 DEIA MLO SMT L120 WH	(0.38, 0.38) SDCM <3
8719514103948	SP342P 52S/940 DEIA MLO SMT L120 WH	(0.38, 0.38) SDCM <3

Productgegevens

Order Code	Full Product Name	Code productfamilie
8719514103788	SP342P 45S/940 DEIA O SMT L150 WH	SP342P
8719514103672	SP342P 45S/940 DEIA PCS SMT L150 BK	SP342P
8719514103658	SP342P 45S/940 DEIA PCS SMT L150 WH	SP342P
8719514103870	SP340P 36S/940 DEIA PCS SMT L120 WH	SP340P
8719514103887	SP340P 42S/940 DEIA PCS SMT L120 WH	SP340P
8719514103917	SP342P 48S/940 DEIA PCS SMT L120 WH	SP342P
8719514708082	SP340P 42S/940 SEIA PCS U4 SMT L120 WH	SP340P

Order Code	Full Product Name	Code productfamilie
8719514708099	SP342P 45S/930 SEIA MLO U4 SMT L150 WH	SP342P
8719514708198	SP340P 40S/940 SEIA MLO U4 SMT L120 WH	SP340P
8719514708204	SP340P 36S/940 SEIA PCS U4 SMT L120 WH	SP340P
8719514708211	SP340P 36S/940 SEIA MLO U4 SMT L120 WH	SP340P
8719514103757	SP342P 45S/940 DEIA MLO SMT L150 BK	SP342P
8719514103665	SP342P 45S/940 DEIA PCS SMT L150 SI	SP342P
8719514103740	SP342P 45S/940 DEIA MLO SMT L150 SI	SP342P

FlexBlend, pendelmontage

Order Code	Full Product Name	Code productfamilie
8719514103733	SP342P 45S/940 DEIA MLO SMT L150 WH	SP342P
8719514103894	SP340P 36S/940 DEIA MLO SMT L120 WH	SP340P
8719514103900	SP340P 40S/940 DEIA MLO SMT L120 WH	SP340P

Order Code	Full Product Name	Code productfamilie
8719514103931	SP342P 48S/940 DEIA MLO SMT L120 WH	SP342P
8719514103948	SP342P 52S/940 DEIA MLO SMT L120 WH	SP342P

Polar Wide Diagrams

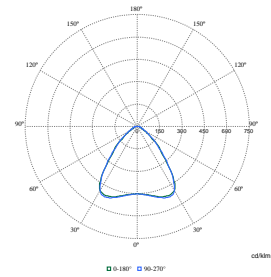
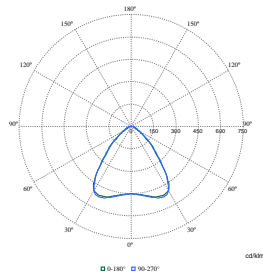
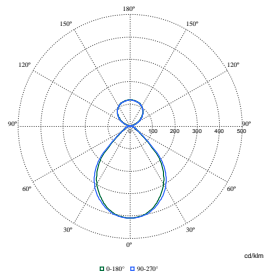

Polar Normal (separate) - SM340CI - 910925868896

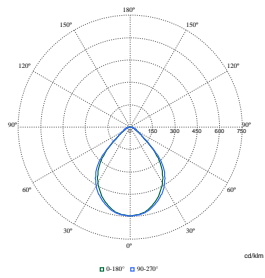

Polar Normal (separate) - SM340CI - 910925868908

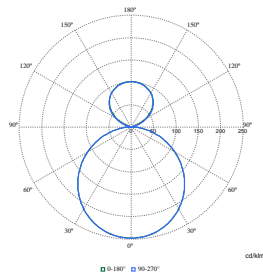

Polar Normal (separate) - SM340CI - 910925868895

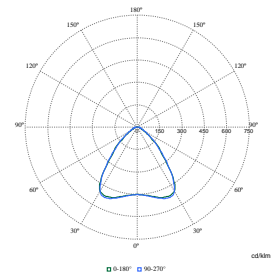

Polar Normal (separate) - SM340CI - 910925868909

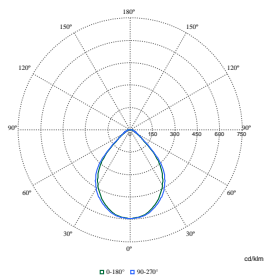

Polar Normal (separate) - SM340CI - 910925867117

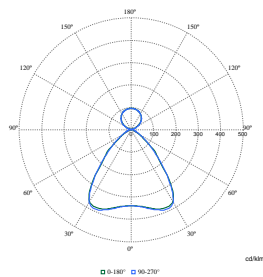

Polar Normal (separate) - SM340CI - 910925867127

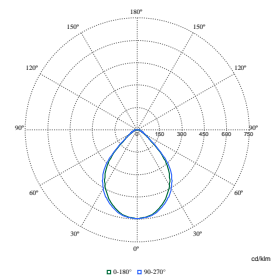

Polar Normal (separate) - SM340CI - 910925867128



Polar Normal (separate) - SM340CI - 910925867105



Polar Normal (separate) - SM340CI - 910925867129



Polar Wide Diagrams

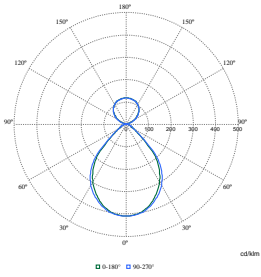

Polar Normal (separate) - SM340CI - 910925867112

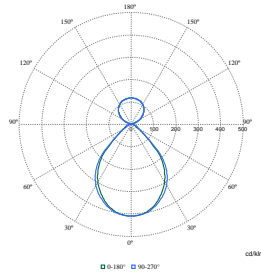

Polar Normal (separate) - SM340CI - 910925867113

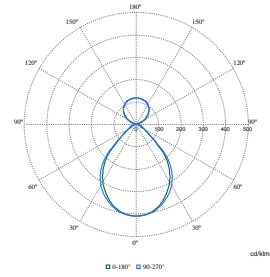

Polar Normal (separate) - SM340CI - 910925867114

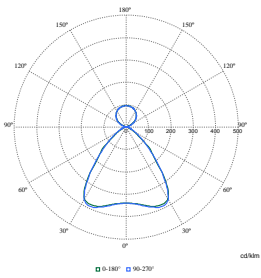

Polar Normal (separate) - SM340CI - 910925867104

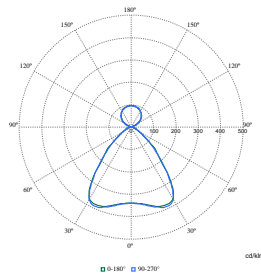

Polar Normal (separate) - SM340CI - 910925867106

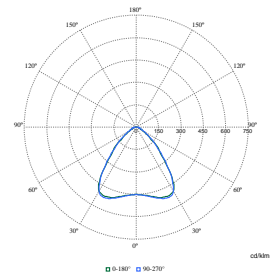

Polar Normal (separate) - SM340CI - 910925867126

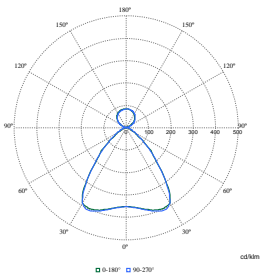

Polar Normal (separate) - SM340CI - 910925867130

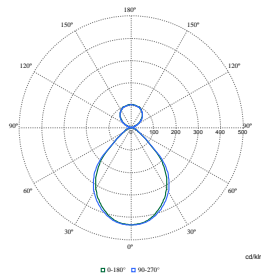

Polar Normal (separate) - SM340CI - 910925867132

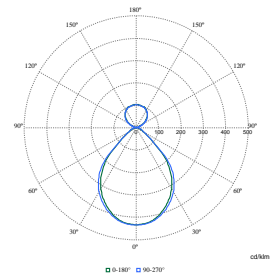

Polar Normal (separate) - SM340CI - 910925867133

FlexBlend, pendelmontage

Polar Wide Diagrams

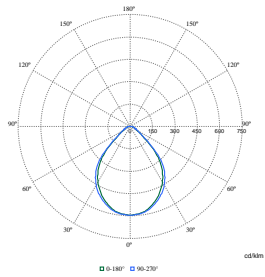

**Polar Normal (separate) - SM340CI -
910925868907**

