



FlexBlend heading the way to efficient and flexible furnished offices areas

FlexBlend, Suspended

Philips FlexBlend is an attractive family of surface mounted and suspended luminaires, next to Flexblend recessed. The luminaire range is enabling building owners to advance their lighting operations, by offering office-compliant lighting with a return on investment of less than 3 to 4 years. FlexBlend provides the required flexibility through the adaptability in design. This gives the possibility to install the luminaires easily in the field, at any moment. Even when today's luminaire is suspended, tomorrow this can be adapted to a surface mounted installation at the venue. And the other way around. The surface mounted and suspended luminaire range fit to many different office spaces like open plan office, corridors, reception or meeting rooms. FlexBlend is offered in both lines and as standalone, using the same lighting module. This gives the option to the users to use FlexBlend as standalone now, and tomorrow, as line. The controller is integrated in the luminaire. As technology is changing fast, the ideal lighting solution is also expected to be ready to incorporate innovations that can help optimize operations further. For this reason, FlexBlend holds all connectivity and future ready options available. As System Ready luminaire it can be paired with lighting management systems such as the Philips SpaceWise, and to software-based lighting systems as Interact Office wired (PoE) and Interact Office wireless and/or existing and upcoming sensor innovations. The luminaire range is therefore future ready and can be delivered without any system component, and in a next phase, in the field to be upgraded. An attractive opportunity for new installations and renovations.

FlexBlend, Suspended

Benefits

- Return of investment less than 3 years
- A flexible office, with application flexibility to the choice of luminaires to fit many office areas
- Future ready: scalable and ready to be connected to controls and lighting systems

Features

- Fully office compliant (UGR <19, L65< 3000cd/sm) , light level according to office applications requirements
- Homogenous and uniform light effect
- Various mounting options, dimensional variety and local options
- Integrated sensors
- Ready to be connected to software based lighting systems such as Interact Office

Application

- Offices
- Education
- Healthcare

Warnings and Safety

- The product is IPX0 & as such is not protected against water ingress & as such we strongly recommend that the environment in which the luminaire is to be installed is suitably checked
- If The above advice is not taken and the luminaires are subject to water ingress, Philips / Signify cannot guarantee safe failure & product warranty will become void

Versions



FlexBlend Surface Mounted-
Suspended Emergency Lighting



FlexBlend Suspended SP340P PCS
BK



FlexBlend Suspended SP340P
MLO BK



FlexBlend Suspended SP340P O SI

FlexBlend, Suspended

Versions



FlexBlend Suspended SP340P O
BK

Dimensional drawing

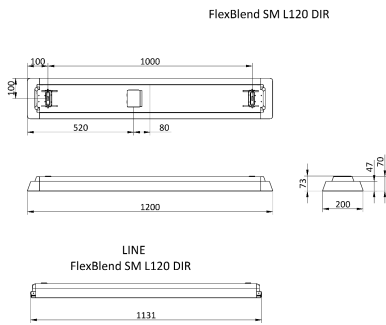
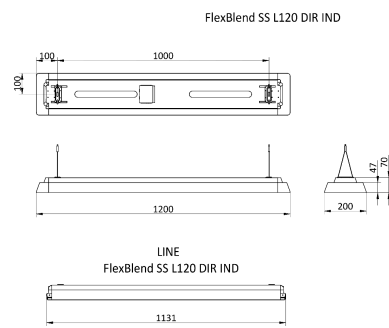
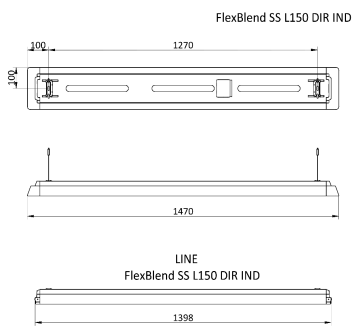

Product details



FlexBlend Suspended SP340P WH



FlexBlend_Surface_Mounted-
Suspended_Emergency Lighting

FlexBlend, Suspended

Product details



FlexBlend Suspended SP340P



FlexBlend Suspended SP340P O
BK



FlexBlend_Surface_Mounted-
Suspended_Emergency Lighting



FlexBlend Suspended SP340P SI

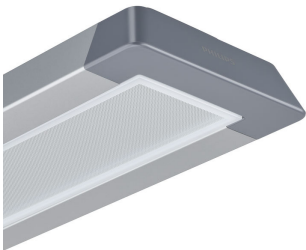

FlexBlend Suspended SP340P
MLO SI

FlexBlend_Surface_Mounted-
Suspended_Emergency Lighting



FlexBlend_Surface_Mounted-
Suspended_Emergency Lighting



FlexBlend Suspended SP340P PCS
WH

FlexBlend, Suspended

Product details

FlexBlend Suspended SP340P O SI

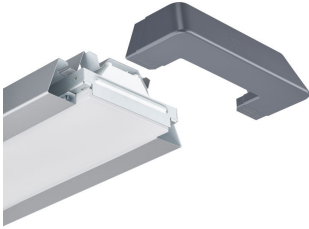

FlexBlend Suspended SP340P O SI

FlexBlend_Surface_Mounted-
Suspended_Emergency Lighting

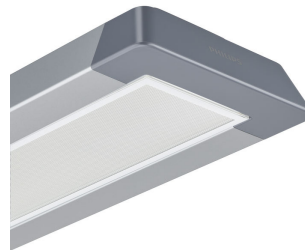

FlexBlend Suspended SP340P PCS
SI

FlexBlend Suspended SP340P PCS
BK



FlexBlend Suspended SP340P SI

FlexBlend Suspended SP340P WH

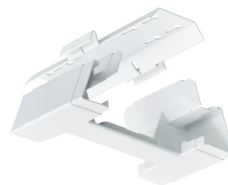

FlexBlend Suspended SP340P BK



FlexBlend, Suspended

Product details



FlexBlend_Suspended_SP340P-
line-MLO-WH-SWZU



FlexBlend Suspended SP340P
MLO BK



FlexBlend Suspended SP340P
MLO BK



FlexBlend_Surface_Mounted-
Suspended_Emergency Lighting



FlexBlend Suspended SP340P BK

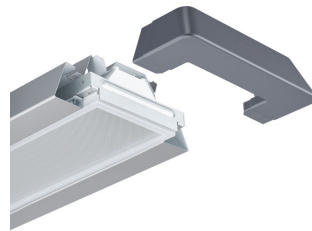

FlexBlend Suspended SP340P
MLO SI



FlexBlend Surface Mounted
SM340C



FlexBlend Suspended SP340P O
WH

FlexBlend, Suspended

Product details



FlexBlend Suspended SP340P
MLO WH



FlexBlend Suspended SP340P SI

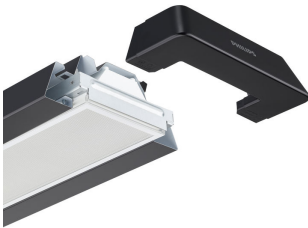

FlexBlend Suspended SP340P PCS
BK



FlexBlend Suspended SP340P BK

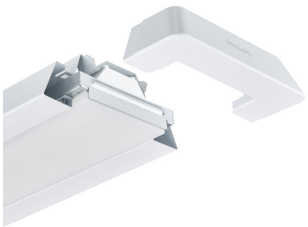

FlexBlend Suspended SP340P O
WH



FlexBlend Suspended SP340P WH



FlexBlend Suspended SP340P WH

FlexBlend, Suspended

Product details

FlexBlend_Surface_Mounted-
Suspended_Emergency Lighting



FlexBlend Suspended SP340P PCS
SI

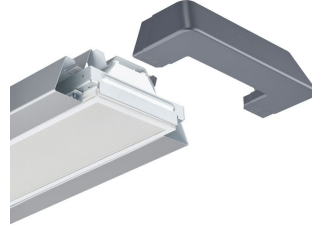

FlexBlend_Surface_Mounted-
Suspended_Emergency Lighting



FlexBlend_Surface_Mounted-
Suspended_Emergency Lighting



FlexBlend Suspended SP340P WH



FlexBlend Suspended SP340P
MLO WH

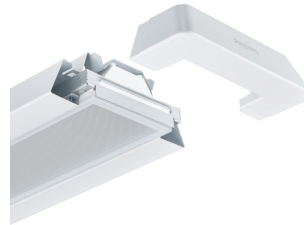

FlexBlend Suspended SP340P BK



FlexBlend Suspended SP340P SI



FlexBlend, Suspended

Product details



FlexBlend Suspended SP340P BK

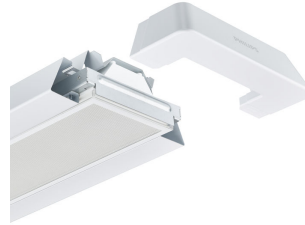

FlexBlend Suspended SP340P PCS
WH

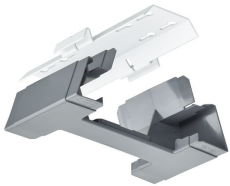

FlexBlend Suspended SP340P SI

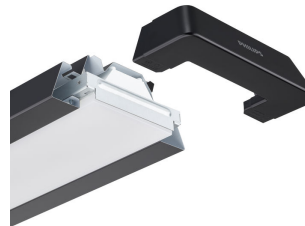

FlexBlend Suspended SP340P O
BK

FlexBlend, Suspended

General Information

Driver included	Yes
Light source replaceable	No
Number of gear units	1 unit
Service tag	Yes

Light Technical

Color rendering index (CRI)	>90
Optic type	Wide beam

Operating and Electrical

Protection class IEC	Safety class I
Input Voltage	220 to 240 V
Line Frequency	50 to 60 Hz

Controls and Dimming

Dimmable	Yes
Maximum dim level	1%

Mechanical and Housing

Mech. impact protection code	IK02
Ingress protection code	IP20

Approval and Application

CE mark	Yes
Flammability mark	For mounting on normally flammable surfaces
Flickering value (PstLM) - Flickering value as per EN 61000-3-3	1
Stroboscopic effect visibility measure (SVM)	0.4

Initial Performance (IEC Compliant)

Luminous flux tolerance	+/-10%
-------------------------	--------

Light Technical

Order Code	Full Product Name	Beam angle of light source	Correlated Color Temperature (Nom)	Luminous Efficacy (rated) (Nom)	Luminous Flux
910925867117	SP342P 45S/940 DEIA O SMT L150 WH	120 degree(s)	4000 K	136 lm/W	4,500 lm
910925867924	SP342P 36S/940 DEIA O SMT L120 WH	120 degree(s)	4000 K	128 lm/W	3,600 lm
910925867940	SP342P 45S/930 DEIA O SMT L150 WH	120 degree(s)	3000 K	136 lm/W	4,500 lm
910925867958	SP343P 35S/940 DEIA O SMT L150 WH	120 degree(s)	4000 K	140 lm/W	3,500 lm
910925868101	SP342P 52S/940 DIA MLO ELP3 SMT L120 WH	120 degree(s)	4000 K	108 lm/W	5,200 lm
910925867106	SP342P 45S/940 DEIA PCS SMT L150 BK	120 degree(s)	4000 K	145 lm/W	4,500 lm
910925867104	SP342P 45S/940 DEIA PCS SMT L150 WH	120 degree(s)	4000 K	145 lm/W	4,500 lm
910925867126	SP340P 36S/940 DEIA PCS SMT L120 WH	120 degree(s)	4000 K	138 lm/W	3,600 lm
910925867127	SP340P 42S/940 DEIA PCS SMT L120 WH	120 degree(s)	4000 K	143 lm/W	4,200 lm
910925867130	SP342P 48S/940 DEIA PCS SMT L120 WH	120 degree(s)	4000 K	141 lm/W	4,800 lm
910925867918	SP342P 36S/940 DEIA PCS SMT L120 WH	120 degree(s)	4000 K	138 lm/W	3,600 lm
910925867932	SP342P 60S/940 DEIA PCS SMT L150 WH	120 degree(s)	4000 K	140 lm/W	6,000 lm
910925867933	SP342P 70S/940 DEIA PCS SMT L150 WH	120 degree(s)	4000 K	137 lm/W	7,000 lm
910925867936	SP342P 45S/930 DEIA PCS SMT L150 WH	120 degree(s)	3000 K	145 lm/W	4,500 lm
910925867937	SP342P 60S/930 DEIA PCS SMT L150 WH	120 degree(s)	3000 K	140 lm/W	6,000 lm
910925867954	SP343P 35S/940 DEIA PCS SMT L150 WH	120 degree(s)	4000 K	140 lm/W	3,500 lm
910925867955	SP343P 45S/940 DEIA PCS SMT L150 WH	120 degree(s)	4000 K	145 lm/W	4,500 lm
910925868894	SP340P 42S/930 SEIA PCS U4 SMT L120 WH	- degree(s)	3000 K	143 lm/W	4,200 lm
910925868895	SP340P 42S/940 SEIA PCS U4 SMT L120 WH	- degree(s)	4000 K	143 lm/W	4,200 lm
910925868896	SP342P 45S/930 SEIA MLO U4 SMT L150 WH	- degree(s)	3000 K	110 lm/W	4,500 lm
910925868897	SP342P 45S/940 SEIA MLO U4 SMT L150 WH	- degree(s)	4000 K	110 lm/W	4,500 lm
910925868905	SP342P 60S/940 SEIA PCS U4 SMT L150 WH	- degree(s)	4000 K	140 lm/W	6,000 lm
910925868906	SP342P 45S/940 SEIA PCS U4 SMT L150 WH	- degree(s)	4000 K	140 lm/W	4,500 lm
910925868907	SP340P 40S/940 SEIA MLO U4 SMT L120 WH	- degree(s)	4000 K	96 lm/W	4,000 lm

FlexBlend, Suspended

Order Code	Full Product Name	Beam angle of light source	Correlated Color Temperature (Nom)	Luminous Efficacy (rated) (Nom)	Luminous Flux
910925868908	SP340P 36S/940 SEIA PCS U4 SMT L120 WH	- degree(s)	4000 K	138 lm/W	3.600 lm
910925868909	SP340P 36S/940 SEIA MLO U4 SMT L120 WH	- degree(s)	4000 K	97 lm/W	3.600 lm
910925867114	SP342P 45S/940 DEIA MLO SMT L150 BK	120 degree(s)	4000 K	112 lm/W	4.500 lm
910925867105	SP342P 45S/940 DEIA PCS SMT L150 SI	120 degree(s)	4000 K	145 lm/W	4.500 lm
910925867925	SP342P 36S/940 DEIA PCS SMT L120 SI	120 degree(s)	4000 K	138 lm/W	3.600 lm
910925867926	SP342P 48S/940 DEIA PCS SMT L120 SI	120 degree(s)	4000 K	138 lm/W	4.800 lm
910925867927	SP342P 56S/940 DEIA PCS SMT L120 SI	120 degree(s)	4000 K	130 lm/W	5.200 lm
910925867941	SP342P 60S/940 DEIA PCS SMT L150 SI	120 degree(s)	4000 K	140 lm/W	6.000 lm
910925867959	SP343P 35S/940 DEIA PCS SMT L150 SI	120 degree(s)	4000 K	140 lm/W	3.500 lm
910925867960	SP343P 45S/940 DEIA PCS SMT L150 SI	120 degree(s)	4000 K	145 lm/W	4.500 lm
910925867113	SP342P 45S/940 DEIA MLO SMT L150 SI	120 degree(s)	4000 K	112 lm/W	4.500 lm
910925867928	SP342P 36S/940 DEIA MLO SMT L120 SI	120 degree(s)	4000 K	112 lm/W	3.600 lm
910925867929	SP342P 48S/940 DEIA MLO SMT L120 SI	120 degree(s)	4000 K	109 lm/W	4.800 lm
910925867930	SP342P 52S/940 DEIA MLO SMT L120 SI	120 degree(s)	4000 K	108 lm/W	5.200 lm
910925867942	SP342P 60S/940 DEIA MLO SMT L150 SI	120 degree(s)	4000 K	102 lm/W	6.000 lm
910925867943	SP342P 66S/940 DEIA MLO SMT L150 SI	120 degree(s)	4000 K	106 lm/W	6.600 lm
910925867961	SP343P 35S/940 DEIA MLO SMT L150 SI	120 degree(s)	4000 K	110 lm/W	3.500 lm
910925867962	SP343P 45S/940 DEIA MLO SMT L150 SI	120 degree(s)	4000 K	112 lm/W	4.500 lm
910925867931	SP342P 36S/940 DEIA O SMT L120 SI	120 degree(s)	4000 K	128 lm/W	3.600 lm
910925867944	SP342P 45S/940 DEIA O SMT L150 SI	120 degree(s)	4000 K	136 lm/W	4.500 lm
910925867963	SP343P 35S/940 DEIA O SMT L150 SI	120 degree(s)	4000 K	140 lm/W	3.500 lm
910925867112	SP342P 45S/940 DEIA MLO SMT L150 WH	120 degree(s)	4000 K	112 lm/W	4.500 lm
910925867128	SP340P 36S/940 DEIA MLO SMT L120 WH	120 degree(s)	4000 K	95 lm/W	3.600 lm
910925867129	SP340P 40S/940 DEIA MLO SMT L120 WH	120 degree(s)	4000 K	94 lm/W	4.000 lm
910925867132	SP342P 48S/940 DEIA MLO SMT L120 WH	120 degree(s)	4000 K	109 lm/W	4.800 lm

FlexBlend, Suspended

Order Code	Full Product Name	Beam angle of light source	Correlated Color Temperature (Nom)	Luminous Efficacy (rated) (Nom)	Luminous Flux
910925867133	SP342P 52S/940 DEIA MLO SMT L120 WH	120 degree(s)	4000 K	108 lm/W	5,200 lm
910925867921	SP342P 36S/940 DEIA MLO SMT L120 WH	120 degree(s)	4000 K	112 lm/W	3,600 lm
910925867934	SP342P 60S/940 DEIA MLO SMT L150 WH	120 degree(s)	4000 K	111 lm/W	6,000 lm
910925867935	SP342P 66S/940 DEIA MLO SMT L150 WH	120 degree(s)	4000 K	106 lm/W	6,600 lm
910925867938	SP342P 45S/930 DEIA MLO SMT L150 WH	120 degree(s)	3000 K	112 lm/W	4,500 lm
910925867939	SP342P 60S/930 DEIA MLO SMT L150 WH	120 degree(s)	3000 K	98.5 lm/W	6,000 lm
910925867956	SP343P 35S/940 DEIA MLO SMT L150 WH	120 degree(s)	4000 K	110 lm/W	3,500 lm
910925867957	SP343P 45S/940 DEIA MLO SMT L150 WH	120 degree(s)	4000 K	112 lm/W	4,500 lm
910925867945	SP342P 45S/940 DEIA O SMT L150 BK	120 degree(s)	4000 K	136 lm/W	4,500 lm

Operating and Electrical

Order Code	Full Product Name	Power Consumption	Suitable for random switching	Order Code	Full Product Name	Power Consumption	Suitable for random switching
910925867117	SP342P 45S/940 DEIA O SMT L150 WH	37.5 W	Yes (relates to presence/movement detection and daylight harvesting)	910925867130	SP342P 48S/940 DEIA PCS SMT L120 WH	36 W	Yes (relates to presence/movement detection and daylight harvesting)
910925867924	SP342P 36S/940 DEIA O SMT L120 WH	29 W	Yes (relates to presence/movement detection and daylight harvesting)	910925867918	SP342P 36S/940 DEIA PCS SMT L120 WH	27 W	Yes (relates to presence/movement detection and daylight harvesting)
910925867940	SP342P 45S/930 DEIA O SMT L150 WH	39 W	Yes (relates to presence/movement detection and daylight harvesting)	910925867932	SP342P 60S/940 DEIA PCS SMT L150 WH	46.5 W	Yes (relates to presence/movement detection and daylight harvesting)
910925867958	SP343P 35S/940 DEIA O SMT L150 WH	29 W	Yes (relates to presence/movement detection and daylight harvesting)	910925867933	SP342P 70S/940 DEIA PCS SMT L150 WH	52 W	Yes (relates to presence/movement detection and daylight harvesting)
910925868101	SP342P 52S/940 DIA MLO ELP3 SMT L120 WH	52.5 W	Yes (relates to presence/movement detection and daylight harvesting)	910925867936	SP342P 45S/930 DEIA PCS SMT L150 WH	36.5 W	Yes (relates to presence/movement detection and daylight harvesting)
910925867106	SP342P 45S/940 DEIA PCS SMT L150 BK	35 W	Yes (relates to presence/movement detection and daylight harvesting)	910925867937	SP342P 60S/930 DEIA PCS SMT L150 WH	49.5 W	Yes (relates to presence/movement detection and daylight harvesting)
910925867104	SP342P 45S/940 DEIA PCS SMT L150 WH	35 W	Yes (relates to presence/movement detection and daylight harvesting)	910925867954	SP343P 35S/940 DEIA PCS SMT L150 WH	27.5 W	Yes (relates to presence/movement detection and daylight harvesting)
910925867126	SP340P 36S/940 DEIA PCS SMT L120 WH	26.5 W	Yes (relates to presence/movement detection and daylight harvesting)	910925867955	SP343P 45S/940 DEIA PCS SMT L150 WH	35 W	Yes (relates to presence/movement detection and daylight harvesting)
910925867127	SP340P 42S/940 DEIA PCS SMT L120 WH	32 W	Yes (relates to presence/movement detection and daylight harvesting)	910925868894	SP340P 42S/930 SEIA PCS U4 SMT L120 WH	27 W	No

FlexBlend, Suspended

Order Code	Full Product Name	Power Consumption	Suitable for random switching
910925868895	SP340P 42S/940 SEIA PCS U4 SMT L120 WH	27 W	No
910925868896	SP342P 45S/930 SEIA MLO U4 SMT L150 WH	44.5 W	No
910925868897	SP342P 45S/940 SEIA MLO U4 SMT L150 WH	42.5 W	No
910925868905	SP342P 60S/940 SEIA PCS U4 SMT L150 WH	46.5 W	No
910925868906	SP342P 45S/940 SEIA PCS U4 SMT L150 WH	35 W	No
910925868907	SP340P 40S/940 SEIA MLO U4 SMT L120 WH	38.5 W	No
910925868908	SP340P 36S/940 SEIA PCS U4 SMT L120 WH	26 W	No
910925868909	SP340P 36S/940 SEIA MLO U4 SMT L120 WH	32.5 W	No
910925867114	SP342P 45S/940 DEIA MLO SMT L150 BK	42.5 W	Yes (relates to presence/ movement detection and daylight harvesting)
910925867105	SP342P 45S/940 DEIA PCS SMT L150 SI	35 W	Yes (relates to presence/ movement detection and daylight harvesting)
910925867925	SP342P 36S/940 DEIA PCS SMT L120 SI	27 W	Yes (relates to presence/ movement detection and daylight harvesting)
910925867926	SP342P 48S/940 DEIA PCS SMT L120 SI	36 W	Yes (relates to presence/ movement detection and daylight harvesting)
910925867927	SP342P 56S/940 DEIA PCS SMT L120 SI	40 W	Yes (relates to presence/ movement detection and daylight harvesting)
910925867941	SP342P 60S/940 DEIA PCS SMT L150 SI	46.5 W	Yes (relates to presence/ movement detection and daylight harvesting)
910925867959	SP343P 35S/940 DEIA PCS SMT L150 SI	27.5 W	Yes (relates to presence/ movement detection and daylight harvesting)
910925867960	SP343P 45S/940 DEIA PCS SMT L150 SI	35 W	Yes (relates to presence/ movement detection and daylight harvesting)
910925867113	SP342P 45S/940 DEIA MLO SMT L150 SI	42.5 W	Yes (relates to presence/ movement detection and daylight harvesting)
910925867928	SP342P 36S/940 DEIA MLO SMT L120 SI	32.5 W	Yes (relates to presence/ movement detection and daylight harvesting)
910925867929	SP342P 48S/940 DEIA MLO SMT L120 SI	44.5 W	Yes (relates to presence/ movement detection and daylight harvesting)

Order Code	Full Product Name	Power Consumption	Suitable for random switching
910925867930	SP342P 52S/940 DEIA MLO SMT L120 SI	48.5 W	Yes (relates to presence/ movement detection and daylight harvesting)
910925867942	SP342P 60S/940 DEIA MLO SMT L150 SI	59 W	Yes (relates to presence/ movement detection and daylight harvesting)
910925867943	SP342P 66S/940 DEIA MLO SMT L150 SI	64 W	Yes (relates to presence/ movement detection and daylight harvesting)
910925867961	SP343P 35S/940 DEIA MLO SMT L150 SI	32.5 W	Yes (relates to presence/ movement detection and daylight harvesting)
910925867962	SP343P 45S/940 DEIA MLO SMT L150 SI	42.5 W	Yes (relates to presence/ movement detection and daylight harvesting)
910925867931	SP342P 36S/940 DEIA O SMT L120 SI	29 W	Yes (relates to presence/ movement detection and daylight harvesting)
910925867944	SP342P 45S/940 DEIA O SMT L150 SI	37.5 W	Yes (relates to presence/ movement detection and daylight harvesting)
910925867963	SP343P 35S/940 DEIA O SMT L150 SI	29 W	Yes (relates to presence/ movement detection and daylight harvesting)
910925867112	SP342P 45S/940 DEIA MLO SMT L150 WH	42.5 W	Yes (relates to presence/ movement detection and daylight harvesting)
910925867128	SP340P 36S/940 DEIA MLO SMT L120 WH	35 W	Yes (relates to presence/ movement detection and daylight harvesting)
910925867129	SP340P 40S/940 DEIA MLO SMT L120 WH	39 W	Yes (relates to presence/ movement detection and daylight harvesting)
910925867132	SP342P 48S/940 DEIA MLO SMT L120 WH	44.5 W	Yes (relates to presence/ movement detection and daylight harvesting)
910925867133	SP342P 52S/940 DEIA MLO SMT L120 WH	48.5 W	Yes (relates to presence/ movement detection and daylight harvesting)
910925867921	SP342P 36S/940 DEIA MLO SMT L120 WH	32.5 W	Yes (relates to presence/ movement detection and daylight harvesting)
910925867934	SP342P 60S/940 DEIA MLO SMT L150 WH	59 W	Yes (relates to presence/ movement detection and daylight harvesting)
910925867935	SP342P 66S/940 DEIA MLO SMT L150 WH	64 W	Yes (relates to presence/ movement detection and daylight harvesting)
910925867938	SP342P 45S/930 DEIA MLO SMT L150 WH	48 W	Yes (relates to presence/ movement detection and daylight harvesting)

FlexBlend, Suspended

Order Code	Full Product Name	Power Consumption	Suitable for random switching
910925867939	SP342P 60S/930 DEIA MLO SMT L150 WH	61 W	Yes (relates to presence/movement detection and daylight harvesting)
910925867956	SP343P 35S/940 DEIA MLO SMT L150 WH	32.5 W	Yes (relates to presence/movement detection and daylight harvesting)

Order Code	Full Product Name	Power Consumption	Suitable for random switching
910925867957	SP343P 45S/940 DEIA MLO SMT L150 WH	42.5 W	Yes (relates to presence/movement detection and daylight harvesting)
910925867945	SP342P 45S/940 DEIA O SMT L150 BK	37.5 W	Yes (relates to presence/movement detection and daylight harvesting)

Controls and Dimming

Order Code	Full Product Name	Embedded control
910925867117	SP342P 45S/940 DEIA O SMT L150 WH	-
910925867924	SP342P 36S/940 DEIA O SMT L120 WH	-
910925867940	SP342P 45S/930 DEIA O SMT L150 WH	-
910925867958	SP343P 35S/940 DEIA O SMT L150 WH	-
910925868101	SP342P 52S/940 DIA MLO ELP3 SMT L120 WH	-
910925867106	SP342P 45S/940 DEIA PCS SMT L150 BK	-
910925867104	SP342P 45S/940 DEIA PCS SMT L150 WH	-
910925867126	SP340P 36S/940 DEIA PCS SMT L120 WH	-
910925867127	SP340P 42S/940 DEIA PCS SMT L120 WH	-
910925867130	SP342P 48S/940 DEIA PCS SMT L120 WH	-
910925867918	SP342P 36S/940 DEIA PCS SMT L120 WH	-
910925867932	SP342P 60S/940 DEIA PCS SMT L150 WH	-
910925867933	SP342P 70S/940 DEIA PCS SMT L150 WH	-
910925867936	SP342P 45S/930 DEIA PCS SMT L150 WH	-
910925867937	SP342P 60S/930 DEIA PCS SMT L150 WH	-
910925867954	SP343P 35S/940 DEIA PCS SMT L150 WH	-
910925867955	SP343P 45S/940 DEIA PCS SMT L150 WH	-
910925868894	SP340P 42S/930 SEIA PCS U4 SMT L120 WH	Upgradable sensor slot with SC200 sensor
910925868895	SP340P 42S/940 SEIA PCS U4 SMT L120 WH	Upgradable sensor slot with SC200 sensor
910925868896	SP342P 45S/930 SEIA MLO U4 SMT L150 WH	Upgradable sensor slot with SC200 sensor
910925868897	SP342P 45S/940 SEIA MLO U4 SMT L150 WH	Upgradable sensor slot with SC200 sensor
910925868905	SP342P 60S/940 SEIA PCS U4 SMT L150 WH	Upgradable sensor slot with SC200 sensor
910925868906	SP342P 45S/940 SEIA PCS U4 SMT L150 WH	Upgradable sensor slot with SC200 sensor
910925868907	SP340P 40S/940 SEIA MLO U4 SMT L120 WH	Upgradable sensor slot with SC200 sensor
910925868908	SP340P 36S/940 SEIA PCS U4 SMT L120 WH	Upgradable sensor slot with SC200 sensor
910925868909	SP340P 36S/940 SEIA MLO U4 SMT L120 WH	Upgradable sensor slot with SC200 sensor

Order Code	Full Product Name	Embedded control
910925867114	SP342P 45S/940 DEIA MLO SMT L150 BK	-
910925867105	SP342P 45S/940 DEIA PCS SMT L150 SI	-
910925867925	SP342P 36S/940 DEIA PCS SMT L120 SI	-
910925867926	SP342P 48S/940 DEIA PCS SMT L120 SI	-
910925867927	SP342P 56S/940 DEIA PCS SMT L120 SI	-
910925867941	SP342P 60S/940 DEIA PCS SMT L150 SI	-
910925867959	SP343P 35S/940 DEIA PCS SMT L150 SI	-
910925867960	SP343P 45S/940 DEIA PCS SMT L150 SI	-
910925867113	SP342P 45S/940 DEIA MLO SMT L150 SI	-
910925867928	SP342P 36S/940 DEIA MLO SMT L120 SI	-
910925867929	SP342P 48S/940 DEIA MLO SMT L120 SI	-
910925867930	SP342P 52S/940 DEIA MLO SMT L120 SI	-
910925867942	SP342P 60S/940 DEIA MLO SMT L150 SI	-
910925867943	SP342P 66S/940 DEIA MLO SMT L150 SI	-
910925867961	SP343P 35S/940 DEIA MLO SMT L150 SI	-
910925867962	SP343P 45S/940 DEIA MLO SMT L150 SI	-
910925867931	SP342P 36S/940 DEIA O SMT L120 SI	-
910925867944	SP342P 45S/940 DEIA O SMT L150 SI	-
910925867963	SP343P 35S/940 DEIA O SMT L150 SI	-
910925867112	SP342P 45S/940 DEIA MLO SMT L150 WH	-
910925867128	SP340P 36S/940 DEIA MLO SMT L120 WH	-
910925867129	SP340P 40S/940 DEIA MLO SMT L120 WH	-
910925867132	SP342P 48S/940 DEIA MLO SMT L120 WH	-
910925867133	SP342P 52S/940 DEIA MLO SMT L120 WH	-
910925867921	SP342P 36S/940 DEIA MLO SMT L120 WH	-
910925867934	SP342P 60S/940 DEIA MLO SMT L150 WH	-
910925867935	SP342P 66S/940 DEIA MLO SMT L150 WH	-
910925867938	SP342P 45S/930 DEIA MLO SMT L150 WH	-
910925867939	SP342P 60S/930 DEIA MLO SMT L150 WH	-
910925867956	SP343P 35S/940 DEIA MLO SMT L150 WH	-
910925867957	SP343P 45S/940 DEIA MLO SMT L150 WH	-
910925867945	SP342P 45S/940 DEIA O SMT L150 BK	-

Mechanical and Housing

Order Code	Full Product Name	Housing Color
910925867117	SP342P 45S/940 DEIA O SMT L150 WH	White

Order Code	Full Product Name	Housing Color
910925867924	SP342P 36S/940 DEIA O SMT L120 WH	White

FlexBlend, Suspended

Order Code	Full Product Name	Housing Color
910925867940	SP342P 45S/930 DEIA O SMT L150 WH	White
910925867958	SP343P 35S/940 DEIA O SMT L150 WH	White
910925868101	SP342P 52S/940 DIA MLO ELP3 SMT L120 WH	White
910925867106	SP342P 45S/940 DEIA PCS SMT L150 BK	Black
910925867104	SP342P 45S/940 DEIA PCS SMT L150 WH	White
910925867126	SP340P 36S/940 DEIA PCS SMT L120 WH	White
910925867127	SP340P 42S/940 DEIA PCS SMT L120 WH	White
910925867130	SP342P 48S/940 DEIA PCS SMT L120 WH	White
910925867918	SP342P 36S/940 DEIA PCS SMT L120 WH	White
910925867932	SP342P 60S/940 DEIA PCS SMT L150 WH	White
910925867933	SP342P 70S/940 DEIA PCS SMT L150 WH	White
910925867936	SP342P 45S/930 DEIA PCS SMT L150 WH	White
910925867937	SP342P 60S/930 DEIA PCS SMT L150 WH	White
910925867954	SP343P 35S/940 DEIA PCS SMT L150 WH	White
910925867955	SP343P 45S/940 DEIA PCS SMT L150 WH	White
910925868894	SP340P 42S/930 SEIA PCS U4 SMT L120 WH	White
910925868895	SP340P 42S/940 SEIA PCS U4 SMT L120 WH	White
910925868896	SP342P 45S/930 SEIA MLO U4 SMT L150 WH	White
910925868897	SP342P 45S/940 SEIA MLO U4 SMT L150 WH	White
910925868905	SP342P 60S/940 SEIA PCS U4 SMT L150 WH	White
910925868906	SP342P 45S/940 SEIA PCS U4 SMT L150 WH	White
910925868907	SP340P 40S/940 SEIA MLO U4 SMT L120 WH	White
910925868908	SP340P 36S/940 SEIA PCS U4 SMT L120 WH	White
910925868909	SP340P 36S/940 SEIA MLO U4 SMT L120 WH	White
910925867114	SP342P 45S/940 DEIA MLO SMT L150 BK	Black
910925867105	SP342P 45S/940 DEIA PCS SMT L150 SI	Silver
910925867925	SP342P 36S/940 DEIA PCS SMT L120 SI	Silver
910925867926	SP342P 48S/940 DEIA PCS SMT L120 SI	Silver

Order Code	Full Product Name	Housing Color
910925867927	SP342P 56S/940 DEIA PCS SMT L120 SI	Silver
910925867941	SP342P 60S/940 DEIA PCS SMT L150 SI	Silver
910925867959	SP343P 35S/940 DEIA PCS SMT L150 SI	Silver
910925867960	SP343P 45S/940 DEIA PCS SMT L150 SI	Silver
910925867113	SP342P 45S/940 DEIA MLO SMT L150 SI	Silver
910925867928	SP342P 36S/940 DEIA MLO SMT L120 SI	Silver
910925867929	SP342P 48S/940 DEIA MLO SMT L120 SI	Silver
910925867930	SP342P 52S/940 DEIA MLO SMT L120 SI	Silver
910925867942	SP342P 60S/940 DEIA MLO SMT L150 SI	Silver
910925867943	SP342P 66S/940 DEIA MLO SMT L150 SI	Silver
910925867961	SP343P 35S/940 DEIA MLO SMT L150 SI	Silver
910925867962	SP343P 45S/940 DEIA MLO SMT L150 SI	Silver
910925867931	SP342P 36S/940 DEIA O SMT L120 SI	Silver
910925867944	SP342P 45S/940 DEIA O SMT L150 SI	Silver
910925867963	SP343P 35S/940 DEIA O SMT L150 SI	Silver
910925867112	SP342P 45S/940 DEIA MLO SMT L150 WH	White
910925867128	SP340P 36S/940 DEIA MLO SMT L120 WH	White
910925867129	SP340P 40S/940 DEIA MLO SMT L120 WH	White
910925867132	SP342P 48S/940 DEIA MLO SMT L120 WH	White
910925867133	SP342P 52S/940 DEIA MLO SMT L120 WH	White
910925867921	SP342P 36S/940 DEIA MLO SMT L120 WH	White
910925867934	SP342P 60S/940 DEIA MLO SMT L150 WH	White
910925867935	SP342P 66S/940 DEIA MLO SMT L150 WH	White
910925867938	SP342P 45S/930 DEIA MLO SMT L150 WH	White
910925867939	SP342P 60S/930 DEIA MLO SMT L150 WH	White
910925867956	SP343P 35S/940 DEIA MLO SMT L150 WH	White
910925867957	SP343P 45S/940 DEIA MLO SMT L150 WH	White
910925867945	SP342P 45S/940 DEIA O SMT L150 BK	Black

Emergency Operation

Order Code	Full Product Name	Central Emergency	Emergency lighting	Rated duration of the emergency lighting (when fully charged)
910925867117	SP342P 45S/940 DEIA O SMT L150 WH	-	-	-
910925867924	SP342P 36S/940 DEIA O SMT L120 WH	-	-	-
910925867940	SP342P 45S/930 DEIA O SMT L150 WH	-	-	-
910925867958	SP343P 35S/940 DEIA O SMT L150 WH	-	-	-
910925868101	SP342P 52S/940 DIA MLO ELP3 SMT L120 WH	No	Emergency lighting 3 hours duration Pro version	3 hour(s)

Order Code	Full Product Name	Central Emergency	Emergency lighting	Rated duration of the emergency lighting (when fully charged)
910925867106	SP342P 45S/940 DEIA PCS SMT L150 BK	-	-	-
910925867104	SP342P 45S/940 DEIA PCS SMT L150 WH	-	-	-
910925867126	SP340P 36S/940 DEIA PCS SMT L120 WH	-	-	-
910925867127	SP340P 42S/940 DEIA PCS SMT L120 WH	-	-	-
910925867130	SP342P 48S/940 DEIA PCS SMT L120 WH	-	-	-
910925867918	SP342P 36S/940 DEIA PCS SMT L120 WH	-	-	-
910925867932	SP342P 60S/940 DEIA PCS SMT L150 WH	-	-	-

FlexBlend, Suspended

Order Code	Full Product Name	Central Emergency	Emergency lighting	Rated duration of the emergency lighting (when fully charged)
910925867933	SP342P 70S/940 DEIA PCS SMT L150 WH	-	-	-
910925867936	SP342P 45S/930 DEIA PCS SMT L150 WH	-	-	-
910925867937	SP342P 60S/930 DEIA PCS SMT L150 WH	-	-	-
910925867954	SP343P 35S/940 DEIA PCS SMT L150 WH	-	-	-
910925867955	SP343P 45S/940 DEIA PCS SMT L150 WH	-	-	-
910925868894	SP340P 42S/930 SEIA PCS U4 SMT L120 WH	-	-	-
910925868895	SP340P 42S/940 SEIA PCS U4 SMT L120 WH	-	-	-
910925868896	SP342P 45S/930 SEIA MLO U4 SMT L150 WH	-	-	-
910925868897	SP342P 45S/940 SEIA MLO U4 SMT L150 WH	-	-	-
910925868905	SP342P 60S/940 SEIA PCS U4 SMT L150 WH	-	-	-
910925868906	SP342P 45S/940 SEIA PCS U4 SMT L150 WH	-	-	-
910925868907	SP340P 40S/940 SEIA MLO U4 SMT L120 WH	-	-	-
910925868908	SP340P 36S/940 SEIA PCS U4 SMT L120 WH	-	-	-
910925868909	SP340P 36S/940 SEIA MLO U4 SMT L120 WH	-	-	-
910925867114	SP342P 45S/940 DEIA MLO SMT L150 BK	-	-	-
910925867105	SP342P 45S/940 DEIA PCS SMT L150 SI	-	-	-
910925867925	SP342P 36S/940 DEIA PCS SMT L120 SI	-	-	-
910925867926	SP342P 48S/940 DEIA PCS SMT L120 SI	-	-	-
910925867927	SP342P 56S/940 DEIA PCS SMT L120 SI	-	-	-
910925867941	SP342P 60S/940 DEIA PCS SMT L150 SI	-	-	-
910925867959	SP343P 35S/940 DEIA PCS SMT L150 SI	-	-	-
910925867960	SP343P 45S/940 DEIA PCS SMT L150 SI	-	-	-
910925867113	SP342P 45S/940 DEIA MLO SMT L150 SI	-	-	-

Order Code	Full Product Name	Central Emergency	Emergency lighting	Rated duration of the emergency lighting (when fully charged)
910925867928	SP342P 36S/940 DEIA MLO SMT L120 SI	-	-	-
910925867929	SP342P 48S/940 DEIA MLO SMT L120 SI	-	-	-
910925867930	SP342P 52S/940 DEIA MLO SMT L120 SI	-	-	-
910925867942	SP342P 60S/940 DEIA MLO SMT L150 SI	-	-	-
910925867943	SP342P 66S/940 DEIA MLO SMT L150 SI	-	-	-
910925867961	SP343P 35S/940 DEIA MLO SMT L150 SI	-	-	-
910925867962	SP343P 45S/940 DEIA MLO SMT L150 SI	-	-	-
910925867931	SP342P 36S/940 DEIA O SMT L120 SI	-	-	-
910925867944	SP342P 45S/940 DEIA O SMT L150 SI	-	-	-
910925867963	SP343P 35S/940 DEIA O SMT L150 SI	-	-	-
910925867112	SP342P 45S/940 DEIA MLO SMT L150 WH	-	-	-
910925867128	SP340P 36S/940 DEIA MLO SMT L120 WH	-	-	-
910925867129	SP340P 40S/940 DEIA MLO SMT L120 WH	-	-	-
910925867132	SP342P 48S/940 DEIA MLO SMT L120 WH	-	-	-
910925867133	SP342P 52S/940 DEIA MLO SMT L120 WH	-	-	-
910925867921	SP342P 36S/940 DEIA MLO SMT L120 WH	-	-	-
910925867934	SP342P 60S/940 DEIA MLO SMT L150 WH	-	-	-
910925867935	SP342P 66S/940 DEIA MLO SMT L150 WH	-	-	-
910925867938	SP342P 45S/930 DEIA MLO SMT L150 WH	-	-	-
910925867939	SP342P 60S/930 DEIA MLO SMT L150 WH	-	-	-
910925867956	SP343P 35S/940 DEIA MLO SMT L150 WH	-	-	-
910925867957	SP343P 45S/940 DEIA MLO SMT L150 WH	-	-	-
910925867945	SP342P 45S/940 DEIA O SMT L150 BK	-	-	-

FlexBlend, Suspended

Approval and Application

Order Code	Full Product Name	Ambient temperature range	ENEC mark	Glow-wire test
910925867117	SP342P 45S/940 DEIA O SMT L150 WH	+10 to +40 °C	ENEC plus mark	Temperature 850 °C, duration 30 s
910925867924	SP342P 36S/940 DEIA O SMT L120 WH	+10 to +40 °C	ENEC plus mark	Temperature 850 °C, duration 30 s
910925867940	SP342P 45S/930 DEIA O SMT L150 WH	+10 to +40 °C	ENEC plus mark	Temperature 850 °C, duration 30 s
910925867958	SP343P 35S/940 DEIA O SMT L150 WH	+10 to +40 °C	ENEC plus mark	Temperature 850 °C, duration 30 s
910925868101	SP342P 52S/940 DIA MLO ELP3 SMT L120 WH	+10 to +25 °C	ENEC plus mark	Temperature 650 °C, duration 30 s
910925867106	SP342P 45S/940 DEIA PCS SMT L150 BK	+10 to +40 °C	ENEC plus mark	Temperature 850 °C, duration 30 s
910925867104	SP342P 45S/940 DEIA PCS SMT L150 WH	+10 to +40 °C	ENEC plus mark	Temperature 850 °C, duration 30 s
910925867126	SP340P 36S/940 DEIA PCS SMT L120 WH	+10 to +40 °C	ENEC plus mark	Temperature 850 °C, duration 30 s
910925867127	SP340P 42S/940 DEIA PCS SMT L120 WH	+10 to +40 °C	ENEC plus mark	Temperature 850 °C, duration 30 s
910925867130	SP342P 48S/940 DEIA PCS SMT L120 WH	+10 to +40 °C	ENEC plus mark	Temperature 850 °C, duration 30 s
910925867918	SP342P 36S/940 DEIA PCS SMT L120 WH	+10 to +40 °C	ENEC plus mark	Temperature 850 °C, duration 30 s
910925867932	SP342P 60S/940 DEIA PCS SMT L150 WH	+10 to +40 °C	ENEC plus mark	Temperature 850 °C, duration 30 s
910925867933	SP342P 70S/940 DEIA PCS SMT L150 WH	+10 to +40 °C	ENEC plus mark	Temperature 850 °C, duration 30 s
910925867936	SP342P 45S/930 DEIA PCS SMT L150 WH	+10 to +40 °C	ENEC plus mark	Temperature 850 °C, duration 30 s
910925867937	SP342P 60S/930 DEIA PCS SMT L150 WH	+10 to +40 °C	ENEC plus mark	Temperature 850 °C, duration 30 s
910925867954	SP343P 35S/940 DEIA PCS SMT L150 WH	+10 to +40 °C	ENEC plus mark	Temperature 850 °C, duration 30 s

Order Code	Full Product Name	Ambient temperature range	ENEC mark	Glow-wire test
910925867955	SP343P 45S/940 DEIA PCS SMT L150 WH	+10 to +40 °C	ENEC plus mark	Temperature 850 °C, duration 30 s
910925868894	SP340P 42S/930 SEIA PCS U4 SMT L120 WH	+10 to +40 °C	ENEC mark	Temperature 850 °C, duration 30 s
910925868895	SP340P 42S/940 SEIA PCS U4 SMT L120 WH	+10 to +40 °C	ENEC mark	Temperature 850 °C, duration 30 s
910925868896	SP342P 45S/930 SEIA MLO U4 SMT L150 WH	+10 to +40 °C	ENEC mark	Temperature 650 °C, duration 30 s
910925868897	SP342P 45S/940 SEIA MLO U4 SMT L150 WH	+10 to +40 °C	ENEC mark	Temperature 650 °C, duration 30 s
910925868905	SP342P 60S/940 SEIA PCS U4 SMT L150 WH	+10 to +40 °C	ENEC mark	Temperature 850 °C, duration 30 s
910925868906	SP342P 45S/940 SEIA PCS U4 SMT L150 WH	+10 to +40 °C	ENEC mark	Temperature 850 °C, duration 30 s
910925868907	SP340P 40S/940 SEIA MLO U4 SMT L120 WH	+10 to +40 °C	ENEC mark	Temperature 650 °C, duration 30 s
910925868908	SP340P 36S/940 SEIA PCS U4 SMT L120 WH	+10 to +40 °C	ENEC mark	Temperature 850 °C, duration 30 s
910925868909	SP340P 36S/940 SEIA MLO U4 SMT L120 WH	+10 to +40 °C	ENEC mark	Temperature 650 °C, duration 30 s
910925867114	SP342P 45S/940 DEIA MLO SMT L150 BK	+10 to +40 °C	ENEC plus mark	Temperature 650 °C, duration 30 s
910925867105	SP342P 45S/940 DEIA PCS SMT L150 SI	+10 to +40 °C	ENEC plus mark	Temperature 850 °C, duration 30 s
910925867925	SP342P 36S/940 DEIA PCS SMT L120 SI	+10 to +40 °C	ENEC plus mark	Temperature 850 °C, duration 30 s
910925867926	SP342P 48S/940 DEIA PCS SMT L120 SI	+10 to +40 °C	ENEC plus mark	Temperature 850 °C, duration 30 s
910925867927	SP342P 56S/940 DEIA PCS SMT L120 SI	+10 to +40 °C	ENEC plus mark	Temperature 850 °C, duration 30 s
910925867941	SP342P 60S/940 DEIA PCS SMT L150 SI	+10 to +40 °C	ENEC plus mark	Temperature 850 °C, duration 30 s

FlexBlend, Suspended

Order Code	Full Product Name	Ambient temperature range	ENEC mark	Glow-wire test
910925867959	SP343P 35S/940 DEIA PCS SMT L150 SI	+10 to +40 °C	ENEC plus mark	Temperature 850 °C, duration 30 s
910925867960	SP343P 45S/940 DEIA PCS SMT L150 SI	+10 to +40 °C	ENEC plus mark	Temperature 850 °C, duration 30 s
910925867113	SP342P 45S/940 DEIA MLO SMT L150 SI	+10 to +40 °C	ENEC plus mark	Temperature 650 °C, duration 30 s
910925867928	SP342P 36S/940 DEIA MLO SMT L120 SI	+10 to +40 °C	ENEC plus mark	Temperature 650 °C, duration 30 s
910925867929	SP342P 48S/940 DEIA MLO SMT L120 SI	+10 to +40 °C	ENEC plus mark	Temperature 650 °C, duration 30 s
910925867930	SP342P 52S/940 DEIA MLO SMT L120 SI	+10 to +40 °C	ENEC plus mark	Temperature 650 °C, duration 30 s
910925867942	SP342P 60S/940 DEIA MLO SMT L150 SI	+10 to +40 °C	ENEC plus mark	Temperature 650 °C, duration 30 s
910925867943	SP342P 66S/940 DEIA MLO SMT L150 SI	+10 to +40 °C	ENEC plus mark	Temperature 650 °C, duration 30 s
910925867961	SP343P 35S/940 DEIA MLO SMT L150 SI	+10 to +40 °C	ENEC plus mark	Temperature 650 °C, duration 30 s
910925867962	SP343P 45S/940 DEIA MLO SMT L150 SI	+10 to +40 °C	ENEC plus mark	Temperature 650 °C, duration 30 s
910925867931	SP342P 36S/940 DEIA O SMT L120 SI	+10 to +40 °C	ENEC plus mark	Temperature 850 °C, duration 30 s
910925867944	SP342P 45S/940 DEIA O SMT L150 SI	+10 to +40 °C	ENEC plus mark	Temperature 850 °C, duration 30 s
910925867963	SP343P 35S/940 DEIA O SMT L150 SI	+10 to +40 °C	ENEC plus mark	Temperature 850 °C, duration 30 s

Order Code	Full Product Name	Ambient temperature range	ENEC mark	Glow-wire test
910925867112	SP342P 45S/940 DEIA MLO SMT L150 WH	+10 to +40 °C	ENEC plus mark	Temperature 650 °C, duration 30 s
910925867128	SP340P 36S/940 DEIA MLO SMT L120 WH	+10 to +40 °C	ENEC plus mark	Temperature 650 °C, duration 30 s
910925867129	SP340P 40S/940 DEIA MLO SMT L120 WH	+10 to +40 °C	ENEC plus mark	Temperature 650 °C, duration 30 s
910925867132	SP342P 48S/940 DEIA MLO SMT L120 WH	+10 to +40 °C	ENEC plus mark	Temperature 650 °C, duration 30 s
910925867133	SP342P 52S/940 DEIA MLO SMT L120 WH	+10 to +40 °C	ENEC plus mark	Temperature 650 °C, duration 30 s
910925867921	SP342P 36S/940 DEIA MLO SMT L120 WH	+10 to +40 °C	ENEC plus mark	Temperature 650 °C, duration 30 s
910925867934	SP342P 60S/940 DEIA MLO SMT L150 WH	+10 to +40 °C	ENEC plus mark	Temperature 650 °C, duration 30 s
910925867935	SP342P 66S/940 DEIA MLO SMT L150 WH	+10 to +40 °C	ENEC plus mark	Temperature 650 °C, duration 30 s
910925867938	SP342P 45S/930 DEIA MLO SMT L150 WH	+10 to +40 °C	ENEC plus mark	Temperature 650 °C, duration 30 s
910925867939	SP342P 60S/930 DEIA MLO SMT L150 WH	+10 to +40 °C	ENEC plus mark	Temperature 650 °C, duration 30 s
910925867956	SP343P 35S/940 DEIA MLO SMT L150 WH	+10 to +40 °C	ENEC plus mark	Temperature 650 °C, duration 30 s
910925867957	SP343P 45S/940 DEIA MLO SMT L150 WH	+10 to +40 °C	ENEC plus mark	Temperature 650 °C, duration 30 s
910925867945	SP342P 45S/940 DEIA O SMT L150 BK	+10 to +40 °C	ENEC plus mark	Temperature 850 °C, duration 30 s

Initial Performance (IEC Compliant)

Order Code	Full Product Name	Initial chromaticity
910925867117	SP342P 45S/940 DEIA O SMT L150 WH	(0.38, 0.38) SDCM <3
910925867924	SP342P 36S/940 DEIA O SMT L120 WH	(0.38, 0.38) SDCM <3
910925867940	SP342P 45S/930 DEIA O SMT L150 WH	(0.43, 0.40) SDCM <3
910925867958	SP343P 35S/940 DEIA O SMT L150 WH	(0.38, 0.38) SDCM <3
910925868101	SP342P 52S/940 DIA MLO ELP3 SMT L120 WH	(0.38, 0.37) SDCM <3
910925867106	SP342P 45S/940 DEIA PCS SMT L150 BK	(0.38, 0.38) SDCM <3
910925867104	SP342P 45S/940 DEIA PCS SMT L150 WH	(0.38, 0.38) SDCM <3

Order Code	Full Product Name	Initial chromaticity
910925867126	SP340P 36S/940 DEIA PCS SMT L120 WH	(0.38, 0.38) SDCM <3
910925867127	SP340P 42S/940 DEIA PCS SMT L120 WH	(0.38, 0.38) SDCM <3
910925867130	SP342P 48S/940 DEIA PCS SMT L120 WH	(0.38, 0.38) SDCM <3
910925867918	SP342P 36S/940 DEIA PCS SMT L120 WH	(0.38, 0.38) SDCM <3
910925867932	SP342P 60S/940 DEIA PCS SMT L150 WH	(0.38, 0.38) SDCM <3
910925867933	SP342P 70S/940 DEIA PCS SMT L150 WH	(0.38, 0.38) SDCM <3
910925867936	SP342P 45S/930 DEIA PCS SMT L150 WH	(0.43, 0.40) SDCM <3

FlexBlend, Suspended

Order Code	Full Product Name	Initial chromaticity
910925867937	SP342P 60S/930 DEIA PCS SMT L150 WH	(0.43, 0.40) SDCM <3
910925867954	SP343P 35S/940 DEIA PCS SMT L150 WH	(0.38, 0.38) SDCM <3
910925867955	SP343P 45S/940 DEIA PCS SMT L150 WH	(0.38, 0.38) SDCM <3
910925868894	SP340P 42S/930 SEIA PCS U4 SMT L120 WH	0.43,0.39
910925868895	SP340P 42S/940 SEIA PCS U4 SMT L120 WH	0.38,0.37
910925868896	SP342P 45S/930 SEIA MLO U4 SMT L150 WH	0.43,0.39
910925868897	SP342P 45S/940 SEIA MLO U4 SMT L150 WH	0.38,0.37
910925868905	SP342P 60S/940 SEIA PCS U4 SMT L150 WH	0.38,0.37
910925868906	SP342P 45S/940 SEIA PCS U4 SMT L150 WH	0.38,0.37
910925868907	SP340P 40S/940 SEIA MLO U4 SMT L120 WH	0.38,0.37
910925868908	SP340P 36S/940 SEIA PCS U4 SMT L120 WH	0.38,0.37
910925868909	SP340P 36S/940 SEIA MLO U4 SMT L120 WH	0.38,0.37
910925867114	SP342P 45S/940 DEIA MLO SMT L150 BK	(0.38, 0.38) SDCM <3
910925867105	SP342P 45S/940 DEIA PCS SMT L150 SI	(0.38, 0.38) SDCM <3
910925867925	SP342P 36S/940 DEIA PCS SMT L120 SI	(0.38, 0.38) SDCM <3
910925867926	SP342P 48S/940 DEIA PCS SMT L120 SI	(0.38, 0.38) SDCM <3
910925867927	SP342P 56S/940 DEIA PCS SMT L120 SI	(0.43, 0.40) SDCM <3
910925867941	SP342P 60S/940 DEIA PCS SMT L150 SI	(0.38, 0.38) SDCM <3
910925867959	SP343P 35S/940 DEIA PCS SMT L150 SI	(0.38, 0.38) SDCM <3
910925867960	SP343P 45S/940 DEIA PCS SMT L150 SI	(0.38, 0.38) SDCM <3
910925867113	SP342P 45S/940 DEIA MLO SMT L150 SI	(0.38, 0.38) SDCM <3
910925867928	SP342P 36S/940 DEIA MLO SMT L120 SI	(0.38, 0.38) SDCM <3

Order Code	Full Product Name	Initial chromaticity
910925867929	SP342P 48S/940 DEIA MLO SMT L120 SI	(0.38, 0.38) SDCM <3
910925867930	SP342P 52S/940 DEIA MLO SMT L120 SI	(0.38, 0.38) SDCM <3
910925867942	SP342P 60S/940 DEIA MLO SMT L150 SI	(0.43, 0.40) SDCM <3
910925867943	SP342P 66S/940 DEIA MLO SMT L150 SI	(0.38, 0.38) SDCM <3
910925867961	SP343P 35S/940 DEIA MLO SMT L150 SI	(0.38, 0.38) SDCM <3
910925867962	SP343P 45S/940 DEIA MLO SMT L150 SI	(0.38, 0.38) SDCM <3
910925867931	SP342P 36S/940 DEIA O SMT L120 SI	(0.38, 0.38) SDCM <3
910925867944	SP342P 45S/940 DEIA O SMT L150 SI	(0.38, 0.38) SDCM <3
910925867963	SP343P 35S/940 DEIA O SMT L150 SI	(0.38, 0.38) SDCM <3
910925867112	SP342P 45S/940 DEIA MLO SMT L150 WH	(0.38, 0.38) SDCM <3
910925867128	SP340P 36S/940 DEIA MLO SMT L120 WH	(0.38, 0.38) SDCM <3
910925867129	SP340P 40S/940 DEIA MLO SMT L120 WH	(0.38, 0.38) SDCM <3
910925867132	SP342P 48S/940 DEIA MLO SMT L120 WH	(0.38, 0.38) SDCM <3
910925867133	SP342P 52S/940 DEIA MLO SMT L120 WH	(0.38, 0.38) SDCM <3
910925867921	SP342P 36S/940 DEIA MLO SMT L120 WH	(0.38, 0.38) SDCM <3
910925867934	SP342P 60S/940 DEIA MLO SMT L150 WH	(0.43, 0.40) SDCM <3
910925867935	SP342P 66S/940 DEIA MLO SMT L150 WH	(0.38, 0.38) SDCM <3
910925867938	SP342P 45S/930 DEIA MLO SMT L150 WH	(0.43, 0.40) SDCM <3
910925867939	SP342P 60S/930 DEIA MLO SMT L150 WH	(0.43, 0.40) SDCM <3
910925867956	SP343P 35S/940 DEIA MLO SMT L150 WH	(0.38, 0.38) SDCM <3
910925867957	SP343P 45S/940 DEIA MLO SMT L150 WH	(0.38, 0.38) SDCM <3
910925867945	SP342P 45S/940 DEIA O SMT L150 BK	(0.38, 0.38) SDCM <3

Over Time Performance (IEC Compliant)

Order Code	Full Product Name	Driver failure rate at 5000 h
910925867117	SP342P 45S/940 DEIA O SMT L150 WH	-
910925867924	SP342P 36S/940 DEIA O SMT L120 WH	-
910925867940	SP342P 45S/930 DEIA O SMT L150 WH	-
910925867958	SP343P 35S/940 DEIA O SMT L150 WH	-
910925868101	SP342P 52S/940 DIA MLO ELP3 SMT L120 WH	0.05 %
910925867106	SP342P 45S/940 DEIA PCS SMT L150 BK	-
910925867104	SP342P 45S/940 DEIA PCS SMT L150 WH	-
910925867126	SP340P 36S/940 DEIA PCS SMT L120 WH	-
910925867127	SP340P 42S/940 DEIA PCS SMT L120 WH	-
910925867130	SP342P 48S/940 DEIA PCS SMT L120 WH	-
910925867918	SP342P 36S/940 DEIA PCS SMT L120 WH	-
910925867932	SP342P 60S/940 DEIA PCS SMT L150 WH	-
910925867933	SP342P 70S/940 DEIA PCS SMT L150 WH	-
910925867936	SP342P 45S/930 DEIA PCS SMT L150 WH	-
910925867937	SP342P 60S/930 DEIA PCS SMT L150 WH	-
910925867954	SP343P 35S/940 DEIA PCS SMT L150 WH	-
910925867955	SP343P 45S/940 DEIA PCS SMT L150 WH	-
910925868894	SP340P 42S/930 SEIA PCS U4 SMT L120 WH	-
910925868895	SP340P 42S/940 SEIA PCS U4 SMT L120 WH	-
910925868896	SP342P 45S/930 SEIA MLO U4 SMT L150 WH	-
910925868897	SP342P 45S/940 SEIA MLO U4 SMT L150 WH	-
910925868905	SP342P 60S/940 SEIA PCS U4 SMT L150 WH	-
910925868906	SP342P 45S/940 SEIA PCS U4 SMT L150 WH	-
910925868907	SP340P 40S/940 SEIA MLO U4 SMT L120 WH	-
910925868908	SP340P 36S/940 SEIA PCS U4 SMT L120 WH	-

Order Code	Full Product Name	Driver failure rate at 5000 h
910925868909	SP340P 36S/940 SEIA MLO U4 SMT L120 WH	-
910925867114	SP342P 45S/940 DEIA MLO SMT L150 BK	-
910925867105	SP342P 45S/940 DEIA PCS SMT L150 SI	-
910925867925	SP342P 36S/940 DEIA PCS SMT L120 SI	-
910925867926	SP342P 48S/940 DEIA PCS SMT L120 SI	-
910925867927	SP342P 56S/940 DEIA PCS SMT L120 SI	-
910925867941	SP342P 60S/940 DEIA PCS SMT L150 SI	-
910925867959	SP343P 35S/940 DEIA PCS SMT L150 SI	-
910925867960	SP343P 45S/940 DEIA PCS SMT L150 SI	-
910925867113	SP342P 45S/940 DEIA MLO SMT L150 SI	-
910925867928	SP342P 36S/940 DEIA MLO SMT L120 SI	-
910925867929	SP342P 48S/940 DEIA MLO SMT L120 SI	-
910925867930	SP342P 52S/940 DEIA MLO SMT L120 SI	-
910925867942	SP342P 60S/940 DEIA MLO SMT L150 SI	-
910925867943	SP342P 66S/940 DEIA MLO SMT L150 SI	-
910925867961	SP343P 35S/940 DEIA MLO SMT L150 SI	-
910925867962	SP343P 45S/940 DEIA MLO SMT L150 SI	-
910925867931	SP342P 36S/940 DEIA O SMT L120 SI	-
910925867944	SP342P 45S/940 DEIA O SMT L150 SI	-
910925867963	SP343P 35S/940 DEIA O SMT L150 SI	-
910925867112	SP342P 45S/940 DEIA MLO SMT L150 WH	-
910925867128	SP340P 36S/940 DEIA MLO SMT L120 WH	-
910925867129	SP340P 40S/940 DEIA MLO SMT L120 WH	-
910925867132	SP342P 48S/940 DEIA MLO SMT L120 WH	-
910925867133	SP342P 52S/940 DEIA MLO SMT L120 WH	-

FlexBlend, Suspended

Order Code	Full Product Name	Driver failure rate at 5000 h
910925867921	SP342P 36S/940 DEIA MLO SMT L120 WH	-
910925867934	SP342P 60S/940 DEIA MLO SMT L150 WH	-
910925867935	SP342P 66S/940 DEIA MLO SMT L150 WH	-
910925867938	SP342P 45S/930 DEIA MLO SMT L150 WH	-

Order Code	Full Product Name	Driver failure rate at 5000 h
910925867939	SP342P 60S/930 DEIA MLO SMT L150 WH	-
910925867956	SP343P 35S/940 DEIA MLO SMT L150 WH	-
910925867957	SP343P 45S/940 DEIA MLO SMT L150 WH	-
910925867945	SP342P 45S/940 DEIA O SMT L150 BK	-

Product Data

Order Code	Full Product Name	Product family code
910925867117	SP342P 45S/940 DEIA O SMT L150 WH	SP342P
910925867924	SP342P 36S/940 DEIA O SMT L120 WH	SP342P
910925867940	SP342P 45S/930 DEIA O SMT L150 WH	SP342P
910925867958	SP343P 35S/940 DEIA O SMT L150 WH	SP343P
910925868101	SP342P 52S/940 DIA MLO ELP3 SMT L120 WH	SP342P
910925867106	SP342P 45S/940 DEIA PCS SMT L150 BK	SP342P
910925867104	SP342P 45S/940 DEIA PCS SMT L150 WH	SP342P
910925867126	SP340P 36S/940 DEIA PCS SMT L120 WH	SP340P
910925867127	SP340P 42S/940 DEIA PCS SMT L120 WH	SP340P
910925867130	SP342P 48S/940 DEIA PCS SMT L120 WH	SP342P
910925867918	SP342P 36S/940 DEIA PCS SMT L120 WH	SP342P
910925867932	SP342P 60S/940 DEIA PCS SMT L150 WH	SP342P
910925867933	SP342P 70S/940 DEIA PCS SMT L150 WH	SP342P
910925867936	SP342P 45S/930 DEIA PCS SMT L150 WH	SP342P
910925867937	SP342P 60S/930 DEIA PCS SMT L150 WH	SP342P
910925867954	SP343P 35S/940 DEIA PCS SMT L150 WH	SP343P
910925867955	SP343P 45S/940 DEIA PCS SMT L150 WH	SP343P
910925868894	SP340P 42S/930 SEIA PCS U4 SMT L120 WH	SP340P
910925868895	SP340P 42S/940 SEIA PCS U4 SMT L120 WH	SP340P
910925868896	SP342P 45S/930 SEIA MLO U4 SMT L150 WH	SP342P
910925868897	SP342P 45S/940 SEIA MLO U4 SMT L150 WH	SP342P
910925868905	SP342P 60S/940 SEIA PCS U4 SMT L150 WH	SP342P
910925868906	SP342P 45S/940 SEIA PCS U4 SMT L150 WH	SP342P
910925868907	SP340P 40S/940 SEIA MLO U4 SMT L120 WH	SP340P
910925868908	SP340P 36S/940 SEIA PCS U4 SMT L120 WH	SP340P
910925868909	SP340P 36S/940 SEIA MLO U4 SMT L120 WH	SP340P
910925867114	SP342P 45S/940 DEIA MLO SMT L150 BK	SP342P
910925867105	SP342P 45S/940 DEIA PCS SMT L150 SI	SP342P
910925867925	SP342P 36S/940 DEIA PCS SMT L120 SI	SP342P

Order Code	Full Product Name	Product family code
910925867926	SP342P 48S/940 DEIA PCS SMT L120 SI	SP342P
910925867927	SP342P 56S/940 DEIA PCS SMT L120 SI	SP342P
910925867941	SP342P 60S/940 DEIA PCS SMT L150 SI	SP342P
910925867959	SP343P 35S/940 DEIA PCS SMT L150 SI	SP343P
910925867960	SP343P 45S/940 DEIA PCS SMT L150 SI	SP343P
910925867113	SP342P 45S/940 DEIA MLO SMT L150 SI	SP342P
910925867928	SP342P 36S/940 DEIA MLO SMT L120 SI	SP342P
910925867929	SP342P 48S/940 DEIA MLO SMT L120 SI	SP342P
910925867930	SP342P 52S/940 DEIA MLO SMT L120 SI	SP342P
910925867942	SP342P 60S/940 DEIA MLO SMT L150 SI	SP342P
910925867943	SP342P 66S/940 DEIA MLO SMT L150 SI	SP342P
910925867961	SP343P 35S/940 DEIA MLO SMT L150 SI	SP343P
910925867962	SP343P 45S/940 DEIA MLO SMT L150 SI	SP343P
910925867931	SP342P 36S/940 DEIA O SMT L120 SI	SP342P
910925867944	SP342P 45S/940 DEIA O SMT L150 SI	SP342P
910925867963	SP343P 35S/940 DEIA O SMT L150 SI	SP343P
910925867112	SP342P 45S/940 DEIA MLO SMT L150 WH	SP342P
910925867128	SP340P 36S/940 DEIA MLO SMT L120 WH	SP340P
910925867129	SP340P 40S/940 DEIA MLO SMT L120 WH	SP340P
910925867132	SP342P 48S/940 DEIA MLO SMT L120 WH	SP342P
910925867133	SP342P 52S/940 DEIA MLO SMT L120 WH	SP342P
910925867921	SP342P 36S/940 DEIA MLO SMT L120 WH	SP342P
910925867934	SP342P 60S/940 DEIA MLO SMT L150 WH	SP342P
910925867935	SP342P 66S/940 DEIA MLO SMT L150 WH	SP342P
910925867938	SP342P 45S/930 DEIA MLO SMT L150 WH	SP342P
910925867939	SP342P 60S/930 DEIA MLO SMT L150 WH	SP342P
910925867956	SP343P 35S/940 DEIA MLO SMT L150 WH	SP343P
910925867957	SP343P 45S/940 DEIA MLO SMT L150 WH	SP343P
910925867945	SP342P 45S/940 DEIA O SMT L150 BK	SP342P

Polar Wide Diagrams

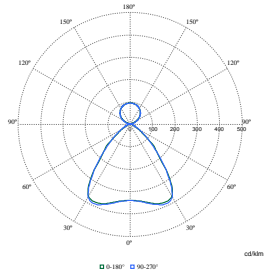

Polar Normal (separate) - SM340CI - 910925868905

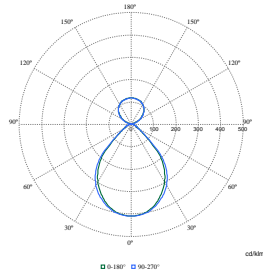

Polar Normal (separate) - SM340CI - 910925868897

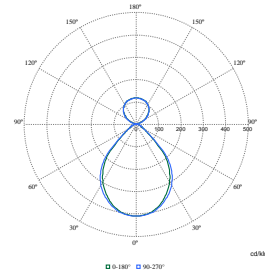

Polar Normal (separate) - SM340CI - 910925868896

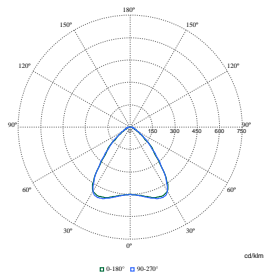

Polar Normal (separate) - SM340CI - 910925868908

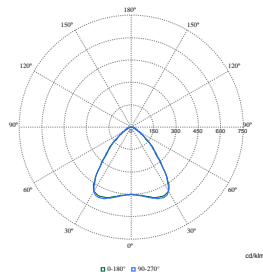

Polar Normal (separate) - SM340CI - 910925868895

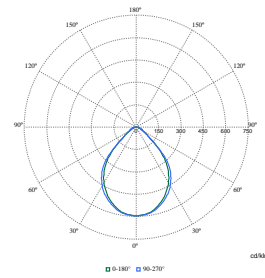

Polar Normal (separate) - SM340CI - 910925868909

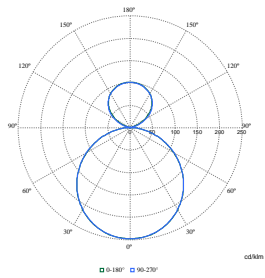

Polar Normal (separate) - SM340CI - 910925867117

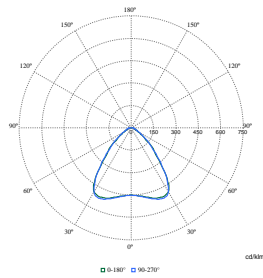

Polar Normal (separate) - SM340CI - 910925867127

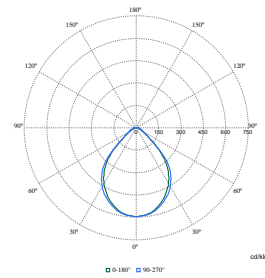

Polar Normal (separate) - SM340CI - 910925867128

Polar Wide Diagrams

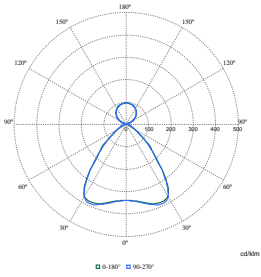

Polar Normal (separate) - SM340CI - 910925867105

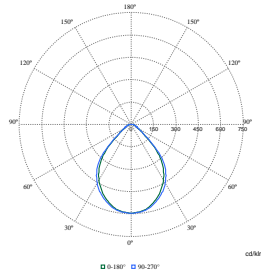

Polar Normal (separate) - SM340CI - 910925867129

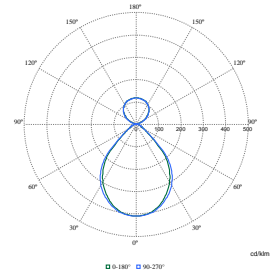

Polar Normal (separate) - SM340CI - 910925867112

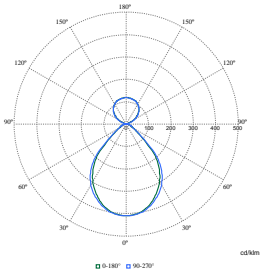

Polar Normal (separate) - SM340CI - 910925867113

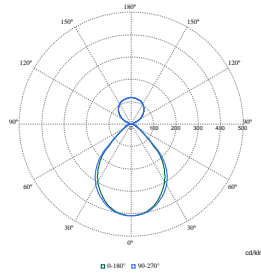

Polar Normal (separate) - SM340CI - 910925867114

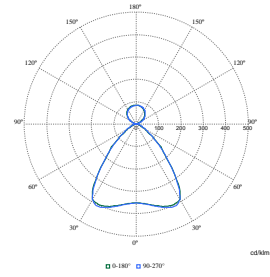

Polar Normal (separate) - SM340CI - 910925867925

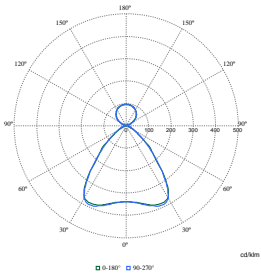

Polar Normal (separate) - SM340CI - 910925867933

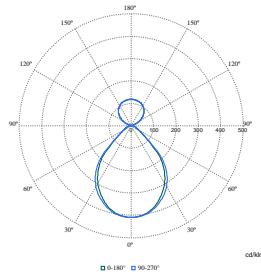

Polar Normal (separate) - SM340CI - 910925867957

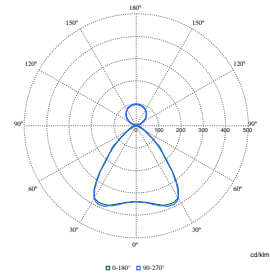

Polar Normal (separate) - SM340CI - 910925867104

Polar Wide Diagrams

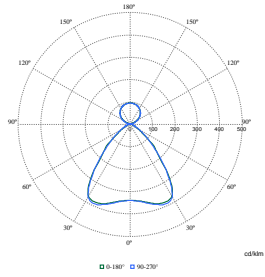

Polar Normal (separate) - SM340CI - 910925867106

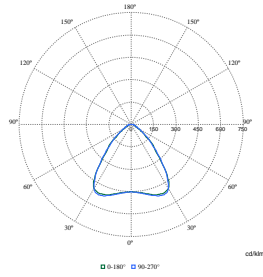

Polar Normal (separate) - SM340CI - 910925867126

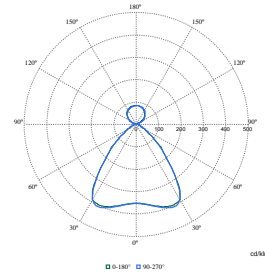

Polar Normal (separate) - SM340CI - 910925867130

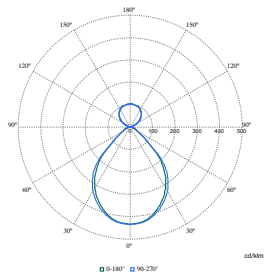

Polar Normal (separate) - SM340CI - 910925867132

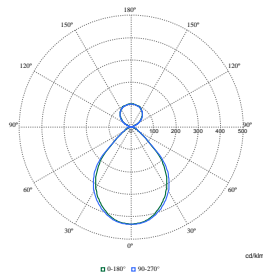

Polar Normal (separate) - SM340CI - 910925867133

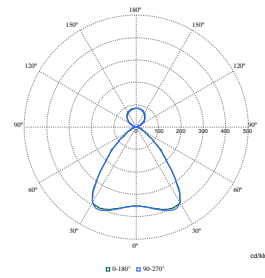

Polar Normal (separate) - SM340CI - 910925867918

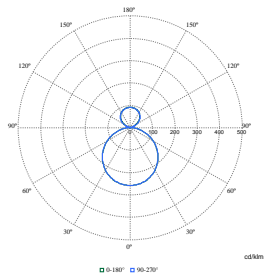

Polar Normal (separate) - SM340CI - 910925867931

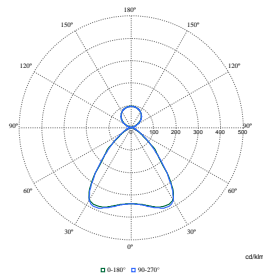

Polar Normal (separate) - SM340CI - 910925867932

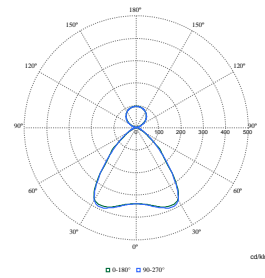

Polar Normal (separate) - SM340CI - 910925867937

Polar Wide Diagrams

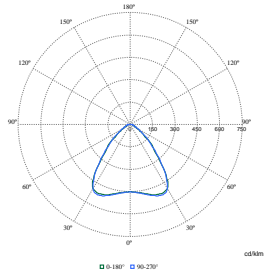

Polar Normal (separate) - SM340CI - 910925868894

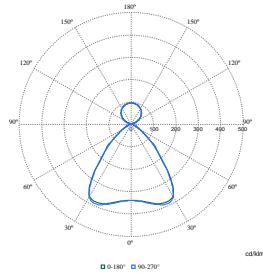

Polar Normal (separate) - SM340CI - 910925868906

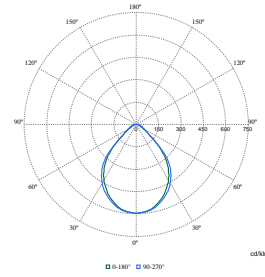

Polar Normal (separate) - SM340CI - 910925868907

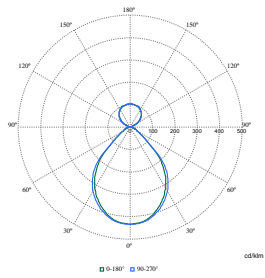

Polar Normal (separate) - SM340CI - 910925867921

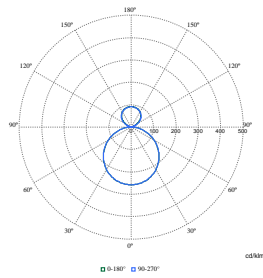

Polar Normal (separate) - SM340CI - 910925867924

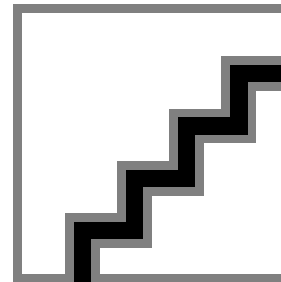

Polar Normal (separate) - SM340CI - 910925867927

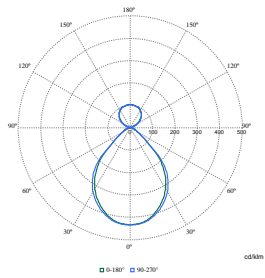

Polar Normal (separate) - SM340CI - 910925867928

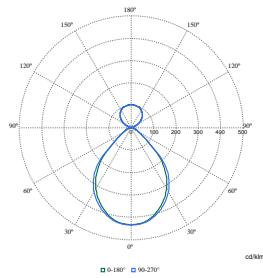

Polar Normal (separate) - SM340CI - 910925867929

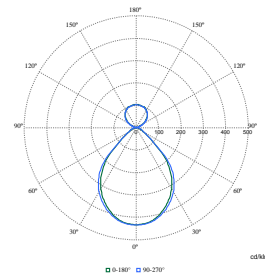

Polar Normal (separate) - SM340CI - 910925867930

Polar Wide Diagrams

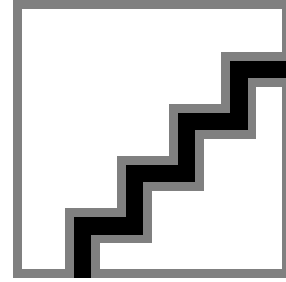
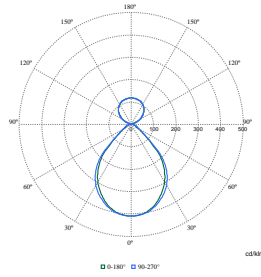
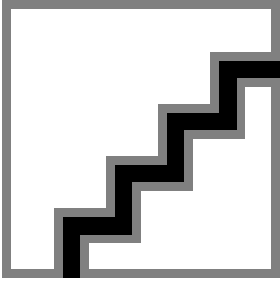

Polar Normal (separate) - SM340CI - 910925867934

Polar Normal (separate) - SM340CI - 910925867935

Polar Normal (separate) - SM340CI - 910925867939

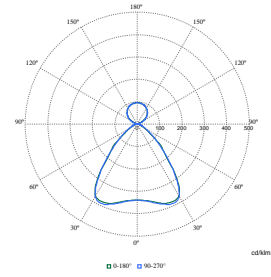
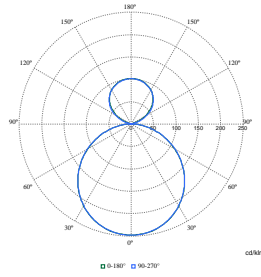
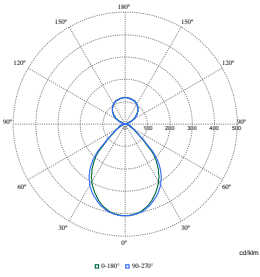

Polar Normal (separate) - SM340CI - 910925867938

Polar Normal (separate) - SM340CI - 910925867940

Polar Normal (separate) - SM340CI - 910925867936

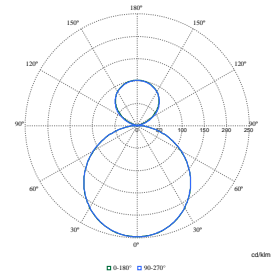
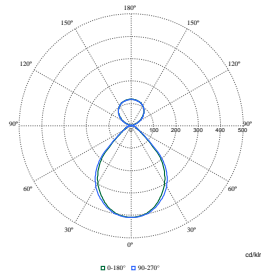
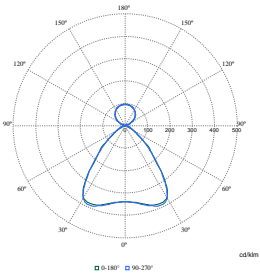

Polar Normal (separate) - SM340CI - 910925867941

Polar Normal (separate) - SM340CI - 910925867943

Polar Normal (separate) - SM340CI - 910925867944

Polar Wide Diagrams

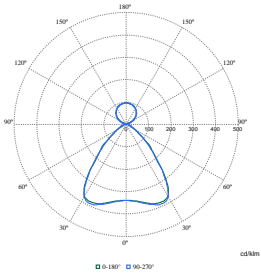

Polar Normal (separate) - SM340CI - 910925867954

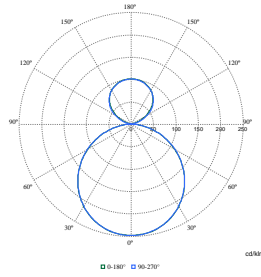

Polar Normal (separate) - SM340CI - 910925867945

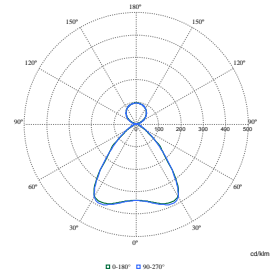

Polar Normal (separate) - SM340CI - 910925867955

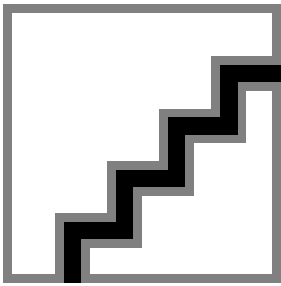

Polar Normal (separate) - SM340CI - 910925867942

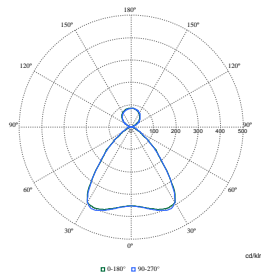

Polar Normal (separate) - SM340CI - 910925867926

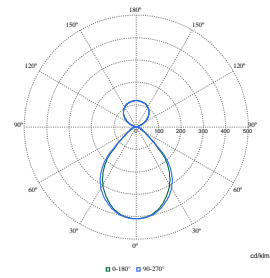

Polar Normal (separate) - SM340CI - 910925867956

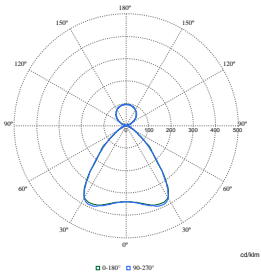

Polar Normal (separate) - SM340CI - 910925867960

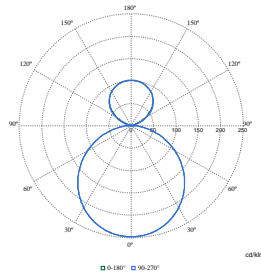

Polar Normal (separate) - SM340CI - 910925867958

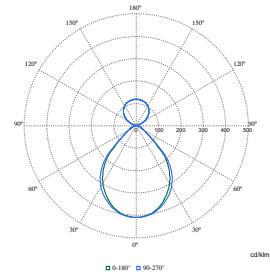

Polar Normal (separate) - SM340CI - 910925867961

FlexBlend, Suspended

Polar Wide Diagrams

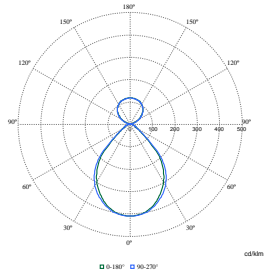

Polar Normal (separate) - SM340CI - 910925867962

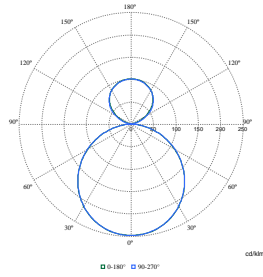

Polar Normal (separate) - SM340CI - 910925867963

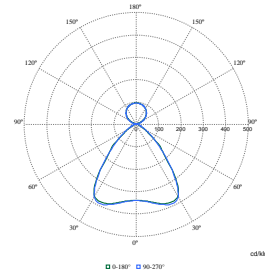

Polar Normal (separate) - SM340CI - 910925867959

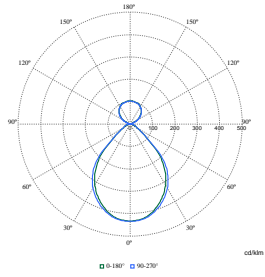

Polar Normal (separate) - SM340CI - 910925868101

