



Flexibilný rad svetiel

KeyLine, povrchové a závesné

V súčasnosti mnohí majitelia kancelárií a dizajnéri kancelárskeho osvetlenia uprednostňujú línie svetla. Dôvod je jednoduchý. Nielenže majú takéto svietidlá minimalistický dizajn, ale zároveň ponúkajú aj oveľa väčšiu možnosť výberu a sú flexibilnejšie. Možné je všetko: krátke alebo dlhé línie, samostatné svietidlá, rôzne optiky vrátane asymetrických, rôzne tvary aj rôzne farby. A s KeyLine prichádzajú všetky tieto výhody za konkurencieschopnú cenu, pričom sú stále v súlade s normami kancelárskeho osvetlenia. KeyLine je vynikajúci rad svetelných línií s tenkým, minimalistickým dizajnom a vysokým svetelným tokom na osvetlenie tých najjasnejších kancelárskych priestorov. Ale vďaka pohodlnej nízkej úrovni oslnenia je tiež nenáročný na oči a vyhovuje norme UGR19. Vďaka tomu je KeyLine ideálny pre lineárne aplikácie, ako aj samostatné závesné alebo prisadené svietidlá (príslušenstvo je potrebné objednať samostatne). Rad, ktorý ponúka maximálnu flexibilitu a neobmedzené možnosti. Flexibilita dizajnu KeyLine prichádza v podobe rôznych dĺžok, farieb a svetelných výstupov – vrátane tvarov L, ako aj rovných línií. Všetky svietidlá sa vyznačujú vysokou účinnosťou až do 142 lm/W a majú možnosť rozšírenia o bezdrôtovú konektivitu a ovládanie. Pridajte k tomu atraktívnu cenu a uvidíte, že svetlá KeyLine ponúkajú veľkú pridanú hodnotu s vynikajúcimi celkovými nákladmi na vlastníctvo.

Výhody

- Vhodné do kancelárskych priestorov
- Vynikajúce celkové náklady na vlastníctvo
- Široká škála možností, ktoré vyhovujú požiadavkám rôznych kancelárskych priestorov

Vlastnosti

- Prijemné s nízkou mierou oslnenia: <UGR19 pre celý modelový rad
- Vysoký svetelný tok až 4 000 lm pri verzii s dĺžkou 1,2 m
- Pripravené na prepojenie so systémom Interact s bezdrôtovými napájačmi
- Štandardné možnosti s rôznymi dĺžkami, farbami a hodnotami svetelného toku
- Možnosti prispôsobenia

KeyLine, povrchové a závesné

Aplikácie

- Kancelárie
- Obchod
- Priestory na vzdelávanie

Varovanie a ochrana

- Svietidlá KeyLine majú krytie IP20 a nie sú chránené pred vniknutím vody. Dôrazne odporúčame kontrolu vhodnosti prostredia, do ktorého sa bude svietidlo inštalovať.
- V prípade, že sú aj napriek upozorneniu na krytie IPX0 svietidlá vystavené vniknutiu vody spoločnosti Philips a Signify nemôžu garantovať bezpečnosť ani zabrániť poruche. V tomto prípade sa na výrobok záruka nevzťahuje a stráca platnosť.

Versions



KeyLine L-corner, black

KeyLine suspended L1500, bk

KeyLine suspended L1200, alu

KeyLine L-corner, alu



KeyLine suspended L1500, alu

KeyLine suspended L1500, white

KeyLine suspended L1200, bk

KeyLine L-corner, white



KeyLine Asymmetric SM531C SPP

KeyLine, povrchové a závesné

Rozmerový obrázok

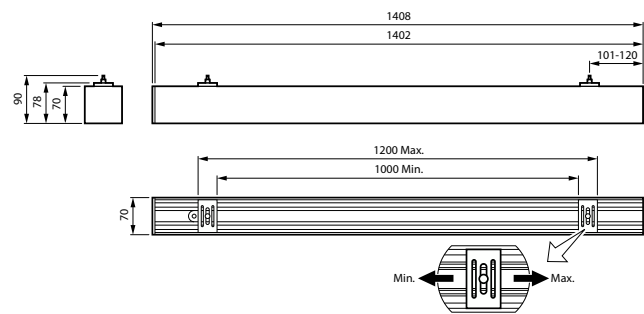
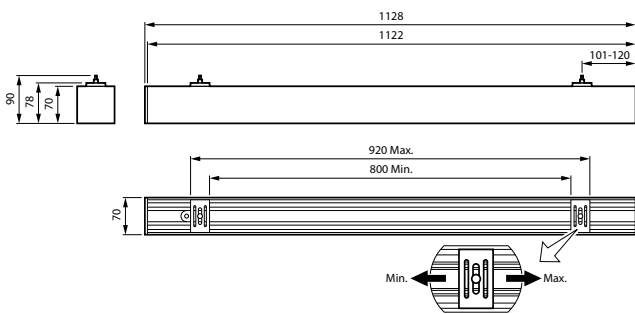
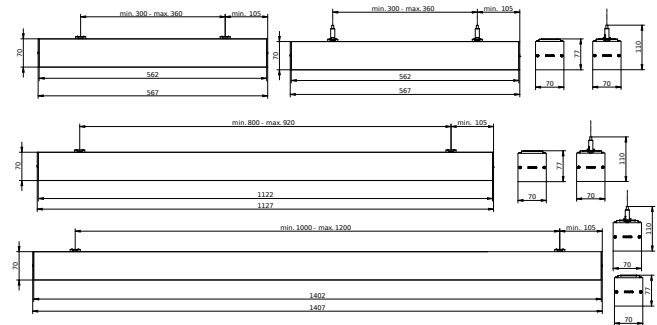
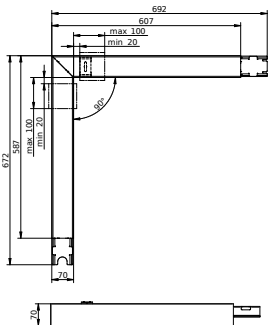

Podrobnosti o produkte



KeyLine line coupling, alu



KeyLine black with ceiling bracket accessory for surface mounting

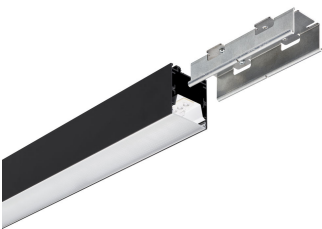

KeyLine black with coupling piece accessory for line mounting



KeyLine Asymmetric SM531C detailed

KeyLine, povrchové a závesné

Podrobnosti o produkte



KeyLine_SM350C_WIA_DPP1



KeyLine line configuration, white



KeyLine SM350C, white



KeyLine configuration with L-corner SM350X



KeyLine black with end-cap accessory



KeyLine line coupling, white



KeyLine alu with suspension set for suspended mounting

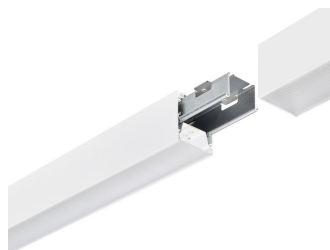

KeyLine white line coupling with coupling piece accessory



KeyLine_SM350C_WIA_DPP3



KeyLine alu with end-cap accessory

KeyLine, povrchové a závesné

Podrobnosti o produkte



KeyLine white with coupling piece accessory for line mounting



KeyLine structured optics UGR19 (PCS)



KeyLine line coupling, black

KeyLine SM350C, alu

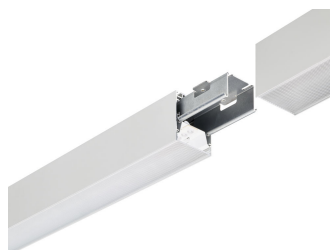

KeyLine alu line coupling with coupling piece accessory

KeyLine line configuration, black



KeyLine alu with ceiling bracket accessory for surface mounting



KeyLine white with suspension set for suspended mounting



KeyLine white with ceiling bracket accessory for surface mounting



KeyLine, povrchové a závesné

Podrobnosti o produkte



KeyLine white with end-cap accessory



KeyLine alu with coupling piece accessory for line mounting



KeyLine SM350C, black



KeyLine L-corner, black

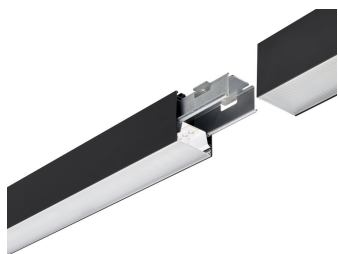

KeyLine black line coupling with coupling piece accessory



KeyLine black with suspension set for suspended mounting



KeyLine_SM350C_WIA_DPP2



KeyLine L-corner, alu

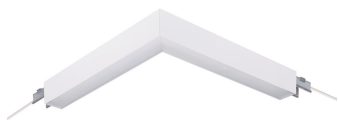

KeyLine L-corner, white

KeyLine, povrchové a závesné

Všeobecné informácie

Vrátane napájača	Áno
Počet jednotiek predradníka	1 jednotka
Servisná značka	Áno

Svetelné technické

Index podania farieb (CRI)	>80
----------------------------	-----

Prevádzkové a elektrické

Trieda ochrany IEC	Bezpečnostná trieda I
Sieťová frekvencia	50 to 60 Hz

Mechanické časti a teleso

Kód krytia IP (mechanický náraz)	IK06
Krytie IP	IP20

Schválenie a použitie

Rozsah okolitých teplôt	+10 až +35 °C
Značka CE	Áno
Značka ENEC	Značka ENEC
Požiarina odolnosť	Teplota 650 °C, trvanie 30 s
Miera viditeľnosti stroboskopického efektu (SVM)	0,4

Počiatočný výkon (súlad s požiadavkami IEC)

Tolerancia svetelného toku	+/-10%
----------------------------	--------

Všeobecné informácie

Order Code	Full Product Name	Vymeniteľný svetelný zdroj
62454200	SM350X 27S/840 PSD PCS N BK	Nie
62442900	SM350C 34S/840 PSU PCS L1500 BK	Nie
62445000	SM350C 50S/840 PSU PCS L1500 BK	Nie
62448100	SM350C 34S/840 PSD PCS L1500 BK	Nie
62451100	SM350C 50S/840 PSD PCS L1500 BK	Nie
62367500	SM350C 27S/840 PSU PCS L1200 ALU	Nie
62417700	SM350C 40S/840 PSU PCS L1200 ALU	Nie
62420700	SM350C 27S/840 PSD PCS L1200 ALU	Nie
62423800	SM350C 40S/840 PSD PCS L1200 ALU	Nie
62432000	SM350C 27S/830 PSU PCS L1200 ALU	Nie
62434400	SM350C 40S/830 PSU PCS L1200 ALU	Nie
62436800	SM350C 27S/830 PSD PCS L1200 ALU	Nie
62438200	SM350C 40S/830 PSD PCS L1200 ALU	Nie
62452800	SM350X 27S/840 PSD L60L60 PCS ALU	Nie
62440500	SM350C 34S/840 PSU PCS L1500 ALU	Nie
62443600	SM350C 50S/840 PSU PCS L1500 ALU	Nie
62446700	SM350C 34S/840 PSD PCS L1500 ALU	Nie
62449800	SM350C 50S/840 PSD PCS L1500 ALU	Nie
62441200	SM350C 34S/840 PSU PCS L1500 WH	Nie
62444300	SM350C 50S/840 PSU PCS L1500 WH	Nie
62447400	SM350C 34S/840 PSD PCS L1500 WH	Nie
62450400	SM350C 50S/840 PSD PCS L1500 WH	Nie
62430600	SM350C 40S/840 WIA PCS L1200 WH	Nie
62431300	SM350C 40S/840 WIA PCS L1200 BK	Nie
62415300	SM350C 27S/840 PSU PCS L1200 WH	Nie
62418400	SM350C 40S/840 PSU PCS L1200 WH	Nie
62421400	SM350C 27S/840 PSD PCS L1200 WH	Nie
62424500	SM350C 40S/840 PSD PCS L1200 WH	Nie
62433700	SM350C 27S/830 PSU PCS L1200 WH	Nie
62435100	SM350C 40S/830 PSU PCS L1200 WH	Nie
62437500	SM350C 27S/830 PSD PCS L1200 WH	Nie
62439900	SM350C 40S/830 PSD PCS L1200 WH	Nie
62416000	SM350C 27S/840 PSU PCS L1200 BK	Nie
62419100	SM350C 40S/840 PSU PCS L1200 BK	Nie
62422100	SM350C 27S/840 PSD PCS L1200 BK	Nie
62425200	SM350C 40S/840 PSD PCS L1200 BK	Nie
62453500	SM350X 27S/840 PSD L60L60 PCS WH	Nie
61518200	SM351C 40S/840 PSU A PCS L1200 WH	-
61519900	SM351C 40S/840 PSD A PCS L1200 WH	-
61520500	SM351C 50S/840 PSU A PCS L1500 WH	-
61521200	SM351C 50S/840 PSD A PCS L1500 WH	-

Svetelné technické (1/2)

KeyLine, povrchové a závesné

Order Code	Full Product Name	Uhol vyžarovania svetelného zdroja	Náhradná teplota chromatickosti (nom.)	Merný výkon (menovitý) (nom.)	Svetelný tok
62454200	SM350X 27S/840 PSD PCS N BK	120 stupeň (stupne)	4000 K	135 lm/W	2 700 lm
62442900	SM350C 34S/840 PSU PCS L1500 BK	120 stupeň (stupne)	4000 K	142 lm/W	3 400 lm
62445000	SM350C 50S/840 PSU PCS L1500 BK	120 stupeň (stupne)	4000 K	135 lm/W	5 000 lm
62448100	SM350C 34S/840 PSD PCS L1500 BK	120 stupeň (stupne)	4000 K	136 lm/W	3 400 lm
62451100	SM350C 50S/840 PSD PCS L1500 BK	120 stupeň (stupne)	4000 K	135 lm/W	5 000 lm
62367500	SM350C 27S/840 PSU PCS L1200 ALU	120 stupeň (stupne)	4000 K	138 lm/W	2 700 lm
62417700	SM350C 40S/840 PSU PCS L1200 ALU	120 stupeň (stupne)	4000 K	133 lm/W	4 000 lm
62420700	SM350C 27S/840 PSD PCS L1200 ALU	120 stupeň (stupne)	4000 K	135 lm/W	2 700 lm
62423800	SM350C 40S/840 PSD PCS L1200 ALU	120 stupeň (stupne)	4000 K	133 lm/W	4 000 lm
62432000	SM350C 27S/830 PSU PCS L1200 ALU	120 stupeň (stupne)	3000 K	132 lm/W	2 700 lm
62434400	SM350C 40S/830 PSU PCS L1200 ALU	120 stupeň (stupne)	3000 K	133 lm/W	4 000 lm
62436800	SM350C 27S/830 PSD PCS L1200 ALU	120 stupeň (stupne)	3000 K	135 lm/W	2 700 lm
62438200	SM350C 40S/830 PSD PCS L1200 ALU	120 stupeň (stupne)	3000 K	129 lm/W	4 000 lm
62452800	SM350X 27S/840 PSD	120 stupeň (stupne)	4000 K	135 lm/W	2 700 lm

Order Code	Full Product Name	Uhol vyžarovania svetelného zdroja	Náhradná teplota chromatickosti (nom.)	Merný výkon (menovitý) (nom.)	Svetelný tok
	L60L60 PCS ALU				
62440500	SM350C 34S/840 PSU PCS L1500 ALU	120 stupeň (stupne)	4000 K	142 lm/W	3 400 lm
62443600	SM350C 50S/840 PSU PCS L1500 ALU	120 stupeň (stupne)	4000 K	135 lm/W	5 000 lm
62446700	SM350C 34S/840 PSD PCS L1500 ALU	120 stupeň (stupne)	4000 K	136 lm/W	3 400 lm
62449800	SM350C 50S/840 PSD PCS L1500 ALU	120 stupeň (stupne)	4000 K	135 lm/W	5 000 lm
62441200	SM350C 34S/840 PSU PCS L1500 WH	120 stupeň (stupne)	4000 K	142 lm/W	3 400 lm
62444300	SM350C 50S/840 PSU PCS L1500 WH	120 stupeň (stupne)	4000 K	135 lm/W	5 000 lm
62447400	SM350C 34S/840 PSD PCS L1500 WH	120 stupeň (stupne)	4000 K	136 lm/W	3 400 lm
62450400	SM350C 50S/840 PSD PCS L1500 WH	120 stupeň (stupne)	4000 K	135 lm/W	5 000 lm
62430600	SM350C 40S/840 WIA PCS L1200 WH	120 stupeň (stupne)	4000 K	133 lm/W	4 000 lm
62431300	SM350C 40S/840 WIA PCS L1200 BK	120 stupeň (stupne)	4000 K	133 lm/W	4 000 lm
62415300	SM350C 27S/840 PSU PCS L1200 WH	120 stupeň (stupne)	4000 K	138 lm/W	2 700 lm
62418400	SM350C 40S/840 PSU PCS L1200 WH	120 stupeň (stupne)	4000 K	133 lm/W	4 000 lm

KeyLine, povrchové a závesné

Order Code	Full Product Name	Uhol vyžarovania svetelného zdroja	Náhradná teplota chromatickosti (nom.)	Merný výkon (menovitý) (nom.)	Svetelný tok
62421400	SM350C 27S/840 PSD PCS L1200 WH	120 stupeň (stupne)	4000 K	135 lm/W	2 700 lm
62424500	SM350C 40S/840 PSD PCS L1200 WH	120 stupeň (stupne)	4000 K	133 lm/W	4 000 lm
62433700	SM350C 27S/830 PSU PCS L1200 WH	120 stupeň (stupne)	3000 K	132 lm/W	2 700 lm
62435100	SM350C 40S/830 PSU PCS L1200 WH	120 stupeň (stupne)	3000 K	133 lm/W	4 000 lm
62437500	SM350C 27S/830 PSD PCS L1200 WH	120 stupeň (stupne)	3000 K	135 lm/W	2 700 lm
62439900	SM350C 40S/830 PSD PCS L1200 WH	120 stupeň (stupne)	3000 K	129 lm/W	4 000 lm
62416000	SM350C 27S/840 PSU PCS L1200 BK	120 stupeň (stupne)	4000 K	138 lm/W	2 700 lm
62419100	SM350C 40S/840 PSU PCS L1200 BK	120 stupeň (stupne)	4000 K	133 lm/W	4 000 lm

Order Code	Full Product Name	Uhol vyžarovania svetelného zdroja	Náhradná teplota chromatickosti (nom.)	Merný výkon (menovitý) (nom.)	Svetelný tok
62422100	SM350C 27S/840 PSD PCS L1200 BK	120 stupeň (stupne)	4000 K	135 lm/W	2 700 lm
62425200	SM350C 40S/840 PSD PCS L1200 BK	120 stupeň (stupne)	4000 K	133 lm/W	4 000 lm
62453500	SM350X 27S/840 PSD L60L60 PCS WH	120 stupeň (stupne)	4000 K	135 lm/W	2 700 lm
61518200	SM351C 40S/840 PSU A PCS L1200 WH	-	4000 K	133 lm/W	4 000 lm
61519900	SM351C 40S/840 PSD A PCS L1200 WH	-	4000 K	133 lm/W	4 000 lm
61520500	SM351C 50S/840 PSU A PCS L1500 WH	-	4000 K	135 lm/W	5 000 lm
61521200	SM351C 50S/840 PSD A PCS L1500 WH	-	4000 K	132 lm/W	5 000 lm

Svetelné technické (2/2)

Order Code	Full Product Name	Typ optiky
62454200	SM350X 27S/840 PSD PCS N BK	Stredné vyžarovanie
62442900	SM350C 34S/840 PSU PCS L1500 BK	Stredné vyžarovanie
62445000	SM350C 50S/840 PSU PCS L1500 BK	Stredné vyžarovanie
62448100	SM350C 34S/840 PSD PCS L1500 BK	Stredné vyžarovanie
62451100	SM350C 50S/840 PSD PCS L1500 BK	Stredné vyžarovanie
62367500	SM350C 27S/840 PSU PCS L1200 ALU	Stredné vyžarovanie
62417700	SM350C 40S/840 PSU PCS L1200 ALU	Stredné vyžarovanie
62420700	SM350C 27S/840 PSD PCS L1200 ALU	Stredné vyžarovanie
62423800	SM350C 40S/840 PSD PCS L1200 ALU	Stredné vyžarovanie
62432000	SM350C 27S/830 PSU PCS L1200 ALU	Stredné vyžarovanie
62434400	SM350C 40S/830 PSU PCS L1200 ALU	Stredné vyžarovanie
62436800	SM350C 27S/830 PSD PCS L1200 ALU	Stredné vyžarovanie
62438200	SM350C 40S/830 PSD PCS L1200 ALU	Stredné vyžarovanie
62452800	SM350X 27S/840 PSD L60L60 PCS ALU	Stredné vyžarovanie
62440500	SM350C 34S/840 PSU PCS L1500 ALU	Stredné vyžarovanie

Order Code	Full Product Name	Typ optiky
62443600	SM350C 50S/840 PSU PCS L1500 ALU	Stredné vyžarovanie
62446700	SM350C 34S/840 PSD PCS L1500 ALU	Stredné vyžarovanie
62449800	SM350C 50S/840 PSD PCS L1500 ALU	Stredné vyžarovanie
62441200	SM350C 34S/840 PSU PCS L1500 WH	Stredné vyžarovanie
62444300	SM350C 50S/840 PSU PCS L1500 WH	Stredné vyžarovanie
62447400	SM350C 34S/840 PSD PCS L1500 WH	Stredné vyžarovanie
62450400	SM350C 50S/840 PSD PCS L1500 WH	Stredné vyžarovanie
62430600	SM350C 40S/840 WIA PCS L1200 WH	Stredné vyžarovanie
62431300	SM350C 40S/840 WIA PCS L1200 BK	Stredné vyžarovanie
62415300	SM350C 27S/840 PSU PCS L1200 WH	Stredné vyžarovanie
62418400	SM350C 40S/840 PSU PCS L1200 WH	Stredné vyžarovanie
62421400	SM350C 27S/840 PSD PCS L1200 WH	Stredné vyžarovanie
62424500	SM350C 40S/840 PSD PCS L1200 WH	Stredné vyžarovanie
62433700	SM350C 27S/830 PSU PCS L1200 WH	Stredné vyžarovanie
62435100	SM350C 40S/830 PSU PCS L1200 WH	Stredné vyžarovanie

KeyLine, povrchové a závesné

Order Code	Full Product Name	Typ optiky
62437500	SM350C 27S/830 PSD PCS L1200 WH	Stredné vyžarovanie
62439900	SM350C 40S/830 PSD PCS L1200 WH	Stredné vyžarovanie
62416000	SM350C 27S/840 PSU PCS L1200 BK	Stredné vyžarovanie
62419100	SM350C 40S/840 PSU PCS L1200 BK	Stredné vyžarovanie
62422100	SM350C 27S/840 PSD PCS L1200 BK	Stredné vyžarovanie
62425200	SM350C 40S/840 PSD PCS L1200 BK	Stredné vyžarovanie

Order Code	Full Product Name	Typ optiky
62453500	SM350X 27S/840 PSD L60L60 PCS WH	Stredné vyžarovanie
61518200	SM351C 40S/840 PSU A PCS L1200 WH	Asymetrický uhol vyžarovania
61519900	SM351C 40S/840 PSD A PCS L1200 WH	Asymetrický uhol vyžarovania
61520500	SM351C 50S/840 PSU A PCS L1500 WH	Asymetrický uhol vyžarovania
61521200	SM351C 50S/840 PSD A PCS L1500 WH	Asymetrický uhol vyžarovania

Prevádzkové a elektrické

Order Code	Full Product Name	Vstupné napätie	Spotreba	Vhodné pre náhodné prepínanie
62454200	SM350X 27S/840 PSD PCS N BK	220 až 240 V	21 W	Nie
62442900	SM350C 34S/840 PSU PCS L1500 BK	220 až 240 V	25 W	Nie
62445000	SM350C 50S/840 PSU PCS L1500 BK	220 až 240 V	36,5 W	Nie
62448100	SM350C 34S/840 PSD PCS L1500 BK	220 až 240 V	26 W	Nie
62451100	SM350C 50S/840 PSD PCS L1500 BK	220 až 240 V	38 W	Nie
62367500	SM350C 27S/840 PSU PCS L1200 ALU	220 až 240 V	20,5 W	Nie
62417700	SM350C 40S/840 PSU PCS L1200 ALU	220 až 240 V	30 W	Nie
62420700	SM350C 27S/840 PSD PCS L1200 ALU	220 až 240 V	21 W	Nie
62423800	SM350C 40S/840 PSD PCS L1200 ALU	220 až 240 V	31 W	Nie
62432000	SM350C 27S/830 PSU PCS L1200 ALU	220 až 240 V	20,5 W	Nie
62434400	SM350C 40S/830 PSU PCS L1200 ALU	220 až 240 V	30 W	Nie
62436800	SM350C 27S/830 PSD PCS L1200 ALU	220 až 240 V	21 W	Nie
62438200	SM350C 40S/830 PSD PCS L1200 ALU	220 až 240 V	31 W	Nie
62452800	SM350X 27S/840 PSD L60L60 PCS ALU	220 až 240 V	21 W	Nie
62440500	SM350C 34S/840 PSU PCS L1500 ALU	220 až 240 V	25 W	Nie
62443600	SM350C 50S/840 PSU PCS L1500 ALU	220 až 240 V	36,5 W	Nie
62446700	SM350C 34S/840 PSD PCS L1500 ALU	220 až 240 V	26 W	Nie
62449800	SM350C 50S/840 PSD PCS L1500 ALU	220 až 240 V	38 W	Nie
62441200	SM350C 34S/840 PSU PCS L1500 WH	220 až 240 V	25 W	Nie
62444300	SM350C 50S/840 PSU PCS L1500 WH	220 až 240 V	36,5 W	Nie

Order Code	Full Product Name	Vstupné napätie	Spotreba	Vhodné pre náhodné prepínanie
62447400	SM350C 34S/840 PSD PCS L1500 WH	220 až 240 V	26 W	Nie
62450400	SM350C 50S/840 PSD PCS L1500 WH	220 až 240 V	38 W	Nie
62430600	SM350C 40S/840 WIA PCS L1200 WH	220 až 240 V	30 W	Nie
62431300	SM350C 40S/840 WIA PCS L1200 BK	220 až 240 V	30 W	Nie
62415300	SM350C 27S/840 PSU PCS L1200 WH	220 až 240 V	20,5 W	Nie
62418400	SM350C 40S/840 PSU PCS L1200 WH	220 až 240 V	30 W	Nie
62421400	SM350C 27S/840 PSD PCS L1200 WH	220 až 240 V	21 W	Nie
62424500	SM350C 40S/840 PSD PCS L1200 WH	220 až 240 V	31 W	Nie
62433700	SM350C 27S/830 PSU PCS L1200 WH	220 až 240 V	20,5 W	Nie
62435100	SM350C 40S/830 PSU PCS L1200 WH	220 až 240 V	30 W	Nie
62437500	SM350C 27S/830 PSD PCS L1200 WH	220 až 240 V	21 W	Nie
62439900	SM350C 40S/830 PSD PCS L1200 WH	220 až 240 V	31 W	Nie
62416000	SM350C 27S/840 PSU PCS L1200 BK	220 až 240 V	20,5 W	Nie
62419100	SM350C 40S/840 PSU PCS L1200 BK	220 až 240 V	30 W	Nie
62422100	SM350C 27S/840 PSD PCS L1200 BK	220 až 240 V	21 W	Nie
62425200	SM350C 40S/840 PSD PCS L1200 BK	220 až 240 V	31 W	Nie
62453500	SM350X 27S/840 PSD L60L60 PCS WH	220 až 240 V	21 W	Nie
61518200	SM351C 40S/840 PSU A PCS L1200 WH	220-240 V	30 W	Nevzťahuje sa na zariadenie
61519900	SM351C 40S/840 PSD A PCS L1200 WH	220-240 V	31 W	Nevzťahuje sa na zariadenie
61520500	SM351C 50S/840 PSU A PCS L1500 WH	220-240 V	37 W	Nevzťahuje sa na zariadenie

KeyLine, povrchové a závesné

Order Code	Full Product Name	Vstupné napätie	Spotreba	Vhodné pre náhodné prepínanie
61521200	SM351C 50S/840 PSD A PCS L1500 WH	220-240 V	38 W	Nevzfahuje sa na zariadenie

Ovládanie a stmievanie

Order Code	Full Product Name	Stmievateľné	Maximálna úroveň stmievania
62454200	SM350X 27S/840 PSD PCS N BK	Áno	1%
62442900	SM350C 34S/840 PSU PCS L1500 BK	Nie	Nevzfahuje sa na zariadenie
62445000	SM350C 50S/840 PSU PCS L1500 BK	Nie	Nevzfahuje sa na zariadenie
62448100	SM350C 34S/840 PSD PCS L1500 BK	Áno	1%
62451100	SM350C 50S/840 PSD PCS L1500 BK	Áno	1%
62367500	SM350C 27S/840 PSU PCS L1200 ALU	Nie	Nevzfahuje sa na zariadenie
62417700	SM350C 40S/840 PSU PCS L1200 ALU	Nie	Nevzfahuje sa na zariadenie
62420700	SM350C 27S/840 PSD PCS L1200 ALU	Áno	1%
62423800	SM350C 40S/840 PSD PCS L1200 ALU	Áno	1%
62432000	SM350C 27S/830 PSU PCS L1200 ALU	Nie	Nevzfahuje sa na zariadenie
62434400	SM350C 40S/830 PSU PCS L1200 ALU	Nie	Nevzfahuje sa na zariadenie
62436800	SM350C 27S/830 PSD PCS L1200 ALU	Áno	1%
62438200	SM350C 40S/830 PSD PCS L1200 ALU	Áno	1%
62452800	SM350X 27S/840 PSD L60L60 PCS ALU	Áno	1%
62440500	SM350C 34S/840 PSU PCS L1500 ALU	Nie	Nevzfahuje sa na zariadenie
62443600	SM350C 50S/840 PSU PCS L1500 ALU	Nie	Nevzfahuje sa na zariadenie
62446700	SM350C 34S/840 PSD PCS L1500 ALU	Áno	1%
62449800	SM350C 50S/840 PSD PCS L1500 ALU	Áno	1%
62441200	SM350C 34S/840 PSU PCS L1500 WH	Nie	Nevzfahuje sa na zariadenie
62444300	SM350C 50S/840 PSU PCS L1500 WH	Nie	Nevzfahuje sa na zariadenie
62447400	SM350C 34S/840 PSD PCS L1500 WH	Áno	1%

Order Code	Full Product Name	Stmievateľné	Maximálna úroveň stmievania
62450400	SM350C 50S/840 PSD PCS L1500 WH	Áno	1%
62430600	SM350C 40S/840 WIA PCS L1200 WH	Nie	1%
62431300	SM350C 40S/840 WIA PCS L1200 BK	Nie	1%
62415300	SM350C 27S/840 PSU PCS L1200 WH	Nie	Nevzfahuje sa na zariadenie
62418400	SM350C 40S/840 PSU PCS L1200 WH	Nie	Nevzfahuje sa na zariadenie
62421400	SM350C 27S/840 PSD PCS L1200 WH	Áno	1%
62424500	SM350C 40S/840 PSD PCS L1200 WH	Áno	1%
62433700	SM350C 27S/830 PSU PCS L1200 WH	Nie	Nevzfahuje sa na zariadenie
62435100	SM350C 40S/830 PSU PCS L1200 WH	Nie	Nevzfahuje sa na zariadenie
62437500	SM350C 27S/830 PSD PCS L1200 WH	Áno	1%
62439900	SM350C 40S/830 PSD PCS L1200 WH	Áno	1%
62416000	SM350C 27S/840 PSU PCS L1200 BK	Nie	Nevzfahuje sa na zariadenie
62419100	SM350C 40S/840 PSU PCS L1200 BK	Nie	Nevzfahuje sa na zariadenie
62422100	SM350C 27S/840 PSD PCS L1200 BK	Áno	1%
62425200	SM350C 40S/840 PSD PCS L1200 BK	Áno	1%
62453500	SM350X 27S/840 PSD L60L60 PCS WH	Áno	1%
61518200	SM351C 40S/840 PSU A PCS L1200 WH	Nie	Nevzfahuje sa na zariadenie
61519900	SM351C 40S/840 PSD A PCS L1200 WH	-	1%
61520500	SM351C 50S/840 PSU A PCS L1500 WH	Nie	Nevzfahuje sa na zariadenie
61521200	SM351C 50S/840 PSD A PCS L1500 WH	-	1%

Mechanické časti a teleso

KeyLine, povrchové a závesné

Order Code	Full Product Name	Farba telesa
62454200	SM350X 27S/840 PSD PCS N BK	Čierna
62442900	SM350C 34S/840 PSU PCS L1500 BK	Čierna
62445000	SM350C 50S/840 PSU PCS L1500 BK	Čierna
62448100	SM350C 34S/840 PSD PCS L1500 BK	Čierna
62451100	SM350C 50S/840 PSD PCS L1500 BK	Čierna
62367500	SM350C 27S/840 PSU PCS L1200 ALU	Hliník
62417700	SM350C 40S/840 PSU PCS L1200 ALU	Hliník
62420700	SM350C 27S/840 PSD PCS L1200 ALU	Hliník
62423800	SM350C 40S/840 PSD PCS L1200 ALU	Hliník
62432000	SM350C 27S/830 PSU PCS L1200 ALU	Hliník
62434400	SM350C 40S/830 PSU PCS L1200 ALU	Hliník
62436800	SM350C 27S/830 PSD PCS L1200 ALU	Hliník
62438200	SM350C 40S/830 PSD PCS L1200 ALU	Hliník
62452800	SM350X 27S/840 PSD L60L60 PCS ALU	Hliník
62440500	SM350C 34S/840 PSU PCS L1500 ALU	Hliník
62443600	SM350C 50S/840 PSU PCS L1500 ALU	Hliník
62446700	SM350C 34S/840 PSD PCS L1500 ALU	Hliník
62449800	SM350C 50S/840 PSD PCS L1500 ALU	Hliník
62441200	SM350C 34S/840 PSU PCS L1500 WH	Biela
62444300	SM350C 50S/840 PSU PCS L1500 WH	Biela
62447400	SM350C 34S/840 PSD PCS L1500 WH	Biela

Order Code	Full Product Name	Farba telesa
62450400	SM350C 50S/840 PSD PCS L1500 WH	Biela
62430600	SM350C 40S/840 WIA PCS L1200 WH	Biela
62431300	SM350C 40S/840 WIA PCS L1200 BK	Čierna
62415300	SM350C 27S/840 PSU PCS L1200 WH	Biela
62418400	SM350C 40S/840 PSU PCS L1200 WH	Biela
62421400	SM350C 27S/840 PSD PCS L1200 WH	Biela
62424500	SM350C 40S/840 PSD PCS L1200 WH	Biela
62433700	SM350C 27S/830 PSU PCS L1200 WH	Biela
62435100	SM350C 40S/830 PSU PCS L1200 WH	Biela
62437500	SM350C 27S/830 PSD PCS L1200 WH	Biela
62439900	SM350C 40S/830 PSD PCS L1200 WH	Biela
62416000	SM350C 27S/840 PSU PCS L1200 BK	Čierna
62419100	SM350C 40S/840 PSU PCS L1200 BK	Čierna
62422100	SM350C 27S/840 PSD PCS L1200 BK	Čierna
62425200	SM350C 40S/840 PSD PCS L1200 BK	Čierna
62453500	SM350X 27S/840 PSD L60L60 PCS WH	Biela
61518200	SM351C 40S/840 PSU A PCS L1200 WH	Biela
61519900	SM351C 40S/840 PSD A PCS L1200 WH	Biela
61520500	SM351C 50S/840 PSU A PCS L1500 WH	Biela
61521200	SM351C 50S/840 PSD A PCS L1500 WH	Biela

Núdzová prevádzka

Order Code	Full Product Name	Centrálna núdzová prevádzka
62454200	SM350X 27S/840 PSD PCS N BK	-
62442900	SM350C 34S/840 PSU PCS L1500 BK	-
62445000	SM350C 50S/840 PSU PCS L1500 BK	-
62448100	SM350C 34S/840 PSD PCS L1500 BK	-
62451100	SM350C 50S/840 PSD PCS L1500 BK	-
62367500	SM350C 27S/840 PSU PCS L1200 ALU	-
62417700	SM350C 40S/840 PSU PCS L1200 ALU	-
62420700	SM350C 27S/840 PSD PCS L1200 ALU	-
62423800	SM350C 40S/840 PSD PCS L1200 ALU	-
62432000	SM350C 27S/830 PSU PCS L1200 ALU	-
62434400	SM350C 40S/830 PSU PCS L1200 ALU	-
62436800	SM350C 27S/830 PSD PCS L1200 ALU	-
62438200	SM350C 40S/830 PSD PCS L1200 ALU	-
62452800	SM350X 27S/840 PSD L60L60 PCS ALU	-
62440500	SM350C 34S/840 PSU PCS L1500 ALU	-
62443600	SM350C 50S/840 PSU PCS L1500 ALU	-
62446700	SM350C 34S/840 PSD PCS L1500 ALU	-
62449800	SM350C 50S/840 PSD PCS L1500 ALU	-
62441200	SM350C 34S/840 PSU PCS L1500 WH	-
62444300	SM350C 50S/840 PSU PCS L1500 WH	-
62447400	SM350C 34S/840 PSD PCS L1500 WH	-

Order Code	Full Product Name	Centrálna núdzová prevádzka
62450400	SM350C 50S/840 PSD PCS L1500 WH	-
62430600	SM350C 40S/840 WIA PCS L1200 WH	-
62431300	SM350C 40S/840 WIA PCS L1200 BK	-
62415300	SM350C 27S/840 PSU PCS L1200 WH	-
62418400	SM350C 40S/840 PSU PCS L1200 WH	-
62421400	SM350C 27S/840 PSD PCS L1200 WH	-
62424500	SM350C 40S/840 PSD PCS L1200 WH	-
62433700	SM350C 27S/830 PSU PCS L1200 WH	-
62435100	SM350C 40S/830 PSU PCS L1200 WH	-
62437500	SM350C 27S/830 PSD PCS L1200 WH	-
62439900	SM350C 40S/830 PSD PCS L1200 WH	-
62416000	SM350C 27S/840 PSU PCS L1200 BK	-
62419100	SM350C 40S/840 PSU PCS L1200 BK	-
62422100	SM350C 27S/840 PSD PCS L1200 BK	-
62425200	SM350C 40S/840 PSD PCS L1200 BK	-
62453500	SM350X 27S/840 PSD L60L60 PCS WH	-
61518200	SM351C 40S/840 PSU A PCS L1200 WH	Nie
61519900	SM351C 40S/840 PSD A PCS L1200 WH	Nie
61520500	SM351C 50S/840 PSU A PCS L1500 WH	Nie
61521200	SM351C 50S/840 PSD A PCS L1500 WH	Nie

Schválenie a použitie

KeyLine, povrchové a závesné

Order Code	Full Product Name	Značka horľavosti	Hodnota blikania (PstLM) – hodnota blikania podľa normy EN 61000-3-3
62454200	SM350X 27S/840 PSD PCS N BK	Na montáž na bežne horľavých povrchoch	1
62442900	SM350C 34S/840 PSU PCS L1500 BK	Na montáž na bežne horľavých povrchoch	1
62445000	SM350C 50S/840 PSU PCS L1500 BK	Na montáž na bežne horľavých povrchoch	1
62448100	SM350C 34S/840 PSD PCS L1500 BK	Na montáž na bežne horľavých povrchoch	1
62451100	SM350C 50S/840 PSD PCS L1500 BK	Na montáž na bežne horľavých povrchoch	1
62367500	SM350C 27S/840 PSU PCS L1200 ALU	Na montáž na bežne horľavých povrchoch	1
62417700	SM350C 40S/840 PSU PCS L1200 ALU	Na montáž na bežne horľavých povrchoch	1
62420700	SM350C 27S/840 PSD PCS L1200 ALU	Na montáž na bežne horľavých povrchoch	1
62423800	SM350C 40S/840 PSD PCS L1200 ALU	Na montáž na bežne horľavých povrchoch	1
62432000	SM350C 27S/830 PSU PCS L1200 ALU	Na montáž na bežne horľavých povrchoch	1
62434400	SM350C 40S/830 PSU PCS L1200 ALU	Na montáž na bežne horľavých povrchoch	1
62436800	SM350C 27S/830 PSD PCS L1200 ALU	Na montáž na bežne horľavých povrchoch	1
62438200	SM350C 40S/830 PSD PCS L1200 ALU	Na montáž na bežne horľavých povrchoch	1
62452800	SM350X 27S/840 PSD L60L60 PCS ALU	Na montáž na bežne horľavých povrchoch	1
62440500	SM350C 34S/840 PSU PCS L1500 ALU	Na montáž na bežne horľavých povrchoch	1
62443600	SM350C 50S/840 PSU PCS L1500 ALU	Na montáž na bežne horľavých povrchoch	1
62446700	SM350C 34S/840 PSD PCS L1500 ALU	Na montáž na bežne horľavých povrchoch	1
62449800	SM350C 50S/840 PSD PCS L1500 ALU	Na montáž na bežne horľavých povrchoch	1
62441200	SM350C 34S/840 PSU PCS L1500 WH	Na montáž na bežne horľavých povrchoch	1
62444300	SM350C 50S/840 PSU PCS L1500 WH	Na montáž na bežne horľavých povrchoch	1
62447400	SM350C 34S/840 PSD PCS L1500 WH	Na montáž na bežne horľavých povrchoch	1

Order Code	Full Product Name	Značka horľavosti	Hodnota blikania (PstLM) – hodnota blikania podľa normy EN 61000-3-3
62450400	SM350C 50S/840 PSD PCS L1500 WH	Na montáž na bežne horľavých povrchoch	1
62430600	SM350C 40S/840 WIA PCS L1200 WH	Na montáž na bežne horľavých povrchoch	1
62431300	SM350C 40S/840 WIA PCS L1200 BK	Na montáž na bežne horľavých povrchoch	1
62415300	SM350C 27S/840 PSU PCS L1200 WH	Na montáž na bežne horľavých povrchoch	1
62418400	SM350C 40S/840 PSU PCS L1200 WH	Na montáž na bežne horľavých povrchoch	1
62421400	SM350C 27S/840 PSD PCS L1200 WH	Na montáž na bežne horľavých povrchoch	1
62424500	SM350C 40S/840 PSD PCS L1200 WH	Na montáž na bežne horľavých povrchoch	1
62433700	SM350C 27S/830 PSU PCS L1200 WH	Na montáž na bežne horľavých povrchoch	1
62435100	SM350C 40S/830 PSU PCS L1200 WH	Na montáž na bežne horľavých povrchoch	1
62437500	SM350C 27S/830 PSD PCS L1200 WH	Na montáž na bežne horľavých povrchoch	1
62439900	SM350C 40S/830 PSD PCS L1200 WH	Na montáž na bežne horľavých povrchoch	1
62416000	SM350C 27S/840 PSU PCS L1200 BK	Na montáž na bežne horľavých povrchoch	1
62419100	SM350C 40S/840 PSU PCS L1200 BK	Na montáž na bežne horľavých povrchoch	1
62422100	SM350C 27S/840 PSD PCS L1200 BK	Na montáž na bežne horľavých povrchoch	1
62425200	SM350C 40S/840 PSD PCS L1200 BK	Na montáž na bežne horľavých povrchoch	1
62453500	SM350X 27S/840 PSD L60L60 PCS WH	Na montáž na bežne horľavých povrchoch	1
61518200	SM351C 40S/840 PSU A PCS L1200 WH	-	-
61519900	SM351C 40S/840 PSD A PCS L1200 WH	-	-
61520500	SM351C 50S/840 PSU A PCS L1500 WH	-	-
61521200	SM351C 50S/840 PSD A PCS L1500 WH	-	-

Počiatkový výkon (súlad s požiadavkami IEC)

KeyLine, povrchové a závesné

Order Code	Full Product Name	Počítačová chromatickosť
62454200	SM350X 27S/840 PSD PCS N BK	(0.39, 0.38) SDCM <3
62442900	SM350C 34S/840 PSU PCS L1500 BK	(0.39, 0.38) SDCM <3
62445000	SM350C 50S/840 PSU PCS L1500 BK	(0.39, 0.38) SDCM <3
62448100	SM350C 34S/840 PSD PCS L1500 BK	(0.39, 0.38) SDCM <3
62451100	SM350C 50S/840 PSD PCS L1500 BK	(0.39, 0.38) SDCM <3
62367500	SM350C 27S/840 PSU PCS L1200 ALU	(0.39, 0.38) SDCM <3
62417700	SM350C 40S/840 PSU PCS L1200 ALU	(0.39, 0.38) SDCM <3
62420700	SM350C 27S/840 PSD PCS L1200 ALU	(0.39, 0.38) SDCM <3
62423800	SM350C 40S/840 PSD PCS L1200 ALU	(0.39, 0.38) SDCM <3
62432000	SM350C 27S/830 PSU PCS L1200 ALU	(0.43, 0.40) SDCM <3
62434400	SM350C 40S/830 PSU PCS L1200 ALU	(0.43, 0.40) SDCM <3
62436800	SM350C 27S/830 PSD PCS L1200 ALU	(0.43, 0.40) SDCM <3
62438200	SM350C 40S/830 PSD PCS L1200 ALU	(0.43, 0.40) SDCM <3
62452800	SM350X 27S/840 PSD L60L60 PCS ALU	(0.39, 0.38) SDCM <3
62440500	SM350C 34S/840 PSU PCS L1500 ALU	(0.39, 0.38) SDCM <3
62443600	SM350C 50S/840 PSU PCS L1500 ALU	(0.39, 0.38) SDCM <3
62446700	SM350C 34S/840 PSD PCS L1500 ALU	(0.39, 0.38) SDCM <3
62449800	SM350C 50S/840 PSD PCS L1500 ALU	(0.39, 0.38) SDCM <3
62441200	SM350C 34S/840 PSU PCS L1500 WH	(0.39, 0.38) SDCM <3
62444300	SM350C 50S/840 PSU PCS L1500 WH	(0.39, 0.38) SDCM <3
62447400	SM350C 34S/840 PSD PCS L1500 WH	(0.39, 0.38) SDCM <3

Order Code	Full Product Name	Počítačová chromatickosť
62450400	SM350C 50S/840 PSD PCS L1500 WH	(0.39, 0.38) SDCM <3
62430600	SM350C 40S/840 WIA PCS L1200 WH	(0.39, 0.38) SDCM <3
62431300	SM350C 40S/840 WIA PCS L1200 BK	(0.39, 0.38) SDCM <3
62415300	SM350C 27S/840 PSU PCS L1200 WH	(0.39, 0.38) SDCM <3
62418400	SM350C 40S/840 PSU PCS L1200 WH	(0.39, 0.38) SDCM <3
62421400	SM350C 27S/840 PSD PCS L1200 WH	(0.39, 0.38) SDCM <3
62424500	SM350C 40S/840 PSD PCS L1200 WH	(0.39, 0.38) SDCM <3
62433700	SM350C 27S/830 PSU PCS L1200 WH	(0.43, 0.40) SDCM <3
62435100	SM350C 40S/830 PSU PCS L1200 WH	(0.43, 0.40) SDCM <3
62437500	SM350C 27S/830 PSD PCS L1200 WH	(0.43, 0.40) SDCM <3
62439900	SM350C 40S/830 PSD PCS L1200 WH	(0.43, 0.40) SDCM <3
62416000	SM350C 27S/840 PSU PCS L1200 BK	(0.39, 0.38) SDCM <3
62419100	SM350C 40S/840 PSU PCS L1200 BK	(0.39, 0.38) SDCM <3
62422100	SM350C 27S/840 PSD PCS L1200 BK	(0.39, 0.38) SDCM <3
62425200	SM350C 40S/840 PSD PCS L1200 BK	(0.39, 0.38) SDCM <3
62453500	SM350X 27S/840 PSD L60L60 PCS WH	(0.39, 0.38) SDCM <3
61518200	SM351C 40S/840 PSU A PCS L1200 WH	(0.39, 0.38) SDCM <3
61519900	SM351C 40S/840 PSD A PCS L1200 WH	(0.39, 0.38) SDCM <3
61520500	SM351C 50S/840 PSU A PCS L1500 WH	(0.39, 0.38) SDCM <3
61521200	SM351C 50S/840 PSD A PCS L1500 WH	(0.39, 0.38) SDCM <3

Údaje o produkte

Order Code	Full Product Name	Kód radu produktov
62454200	SM350X 27S/840 PSD PCS N BK	SM350X
62442900	SM350C 34S/840 PSU PCS L1500 BK	SM350C
62445000	SM350C 50S/840 PSU PCS L1500 BK	SM350C
62448100	SM350C 34S/840 PSD PCS L1500 BK	SM350C
62451100	SM350C 50S/840 PSD PCS L1500 BK	SM350C
62367500	SM350C 27S/840 PSU PCS L1200 ALU	SM350C
62417700	SM350C 40S/840 PSU PCS L1200 ALU	SM350C
62420700	SM350C 27S/840 PSD PCS L1200 ALU	SM350C
62423800	SM350C 40S/840 PSD PCS L1200 ALU	SM350C
62432000	SM350C 27S/830 PSU PCS L1200 ALU	SM350C
62434400	SM350C 40S/830 PSU PCS L1200 ALU	SM350C
62436800	SM350C 27S/830 PSD PCS L1200 ALU	SM350C
62438200	SM350C 40S/830 PSD PCS L1200 ALU	SM350C
62452800	SM350X 27S/840 PSD L60L60 PCS ALU	SM350X
62440500	SM350C 34S/840 PSU PCS L1500 ALU	SM350C
62443600	SM350C 50S/840 PSU PCS L1500 ALU	SM350C
62446700	SM350C 34S/840 PSD PCS L1500 ALU	SM350C
62449800	SM350C 50S/840 PSD PCS L1500 ALU	SM350C
62441200	SM350C 34S/840 PSU PCS L1500 WH	SM350C
62444300	SM350C 50S/840 PSU PCS L1500 WH	SM350C
62447400	SM350C 34S/840 PSD PCS L1500 WH	SM350C

Order Code	Full Product Name	Kód radu produktov
62450400	SM350C 50S/840 PSD PCS L1500 WH	SM350C
62430600	SM350C 40S/840 WIA PCS L1200 WH	SM350C
62431300	SM350C 40S/840 WIA PCS L1200 BK	SM350C
62415300	SM350C 27S/840 PSU PCS L1200 WH	SM350C
62418400	SM350C 40S/840 PSU PCS L1200 WH	SM350C
62421400	SM350C 27S/840 PSD PCS L1200 WH	SM350C
62424500	SM350C 40S/840 PSD PCS L1200 WH	SM350C
62433700	SM350C 27S/830 PSU PCS L1200 WH	SM350C
62435100	SM350C 40S/830 PSU PCS L1200 WH	SM350C
62437500	SM350C 27S/830 PSD PCS L1200 WH	SM350C
62439900	SM350C 40S/830 PSD PCS L1200 WH	SM350C
62416000	SM350C 27S/840 PSU PCS L1200 BK	SM350C
62419100	SM350C 40S/840 PSU PCS L1200 BK	SM350C
62422100	SM350C 27S/840 PSD PCS L1200 BK	SM350C
62425200	SM350C 40S/840 PSD PCS L1200 BK	SM350C
62453500	SM350X 27S/840 PSD L60L60 PCS WH	SM350X
61518200	SM351C 40S/840 PSU A PCS L1200 WH	SM350C
61519900	SM351C 40S/840 PSD A PCS L1200 WH	SM350C
61520500	SM351C 50S/840 PSU A PCS L1500 WH	SM350C
61521200	SM351C 50S/840 PSD A PCS L1500 WH	SM350C

Polar Wide Diagrams

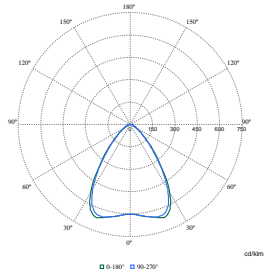

Polar Normal (separate) - SM350CI - 910925868303

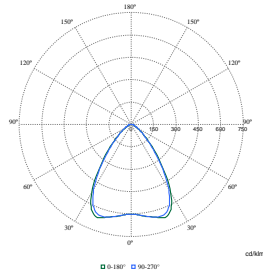

Polar Normal (separate) - SM350CI - 910925868353

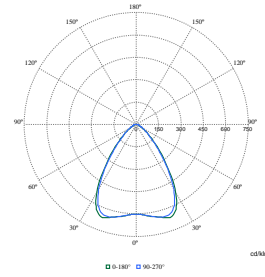

Polar Normal (separate) - SM350CI - 910925868366

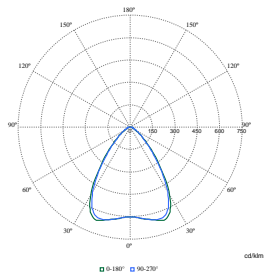

Polar Normal (separate) - SM350CI - 910925868379

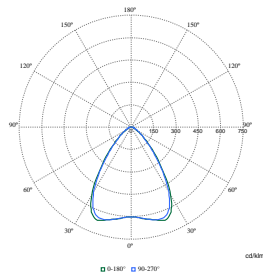

Polar Normal (separate) - SM350CI - 910925868355

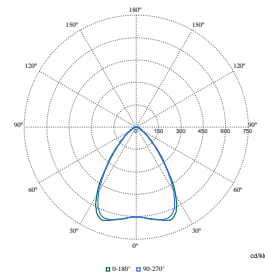

Polar Normal (separate) - SM350CI - 910925868356

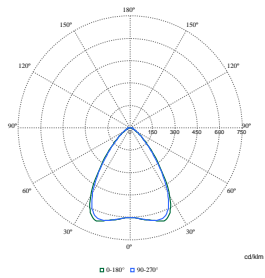

Polar Normal (separate) - SM350CI - 910925868383

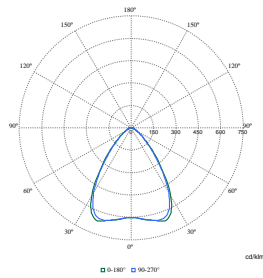

Polar Normal (separate) - SM350CI - 910925868352

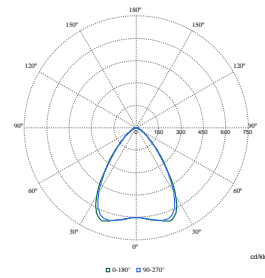

Polar Normal (separate) - SM350CI - 910925868359

Polar Wide Diagrams

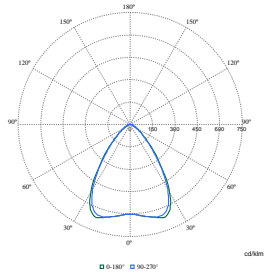

Polar Normal (separate) - SM350CI - 910925868375

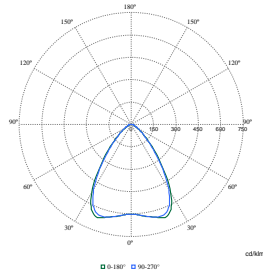

Polar Normal (separate) - SM350CI - 910925868381

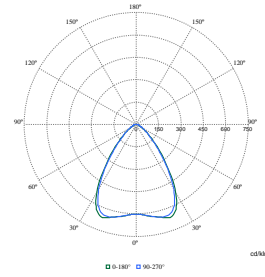

Polar Normal (separate) - SM350CI - 910925868385

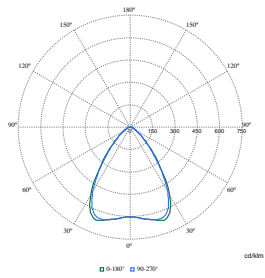

Polar Normal (separate) - SM350CI - 910925868388

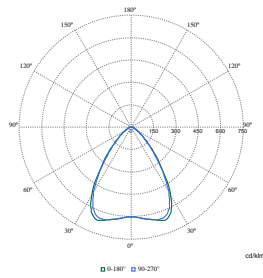

Polar Normal (separate) - SM350CI - 910925868389

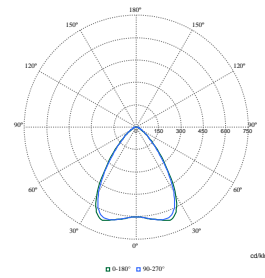

Polar Normal (separate) - SM350CI - 910925868354

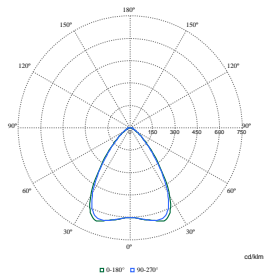

Polar Normal (separate) - SM350CI - 910925868387

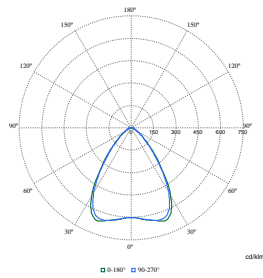

Polar Normal (separate) - SM350CI - 910925868370

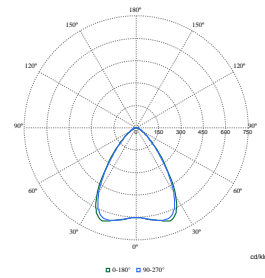

Polar Normal (separate) - SM350CI - 910925868384

Polar Wide Diagrams

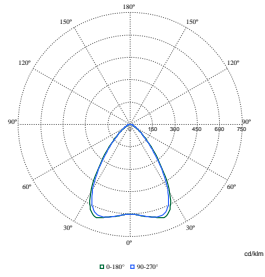

Polar Normal (separate) - SM350CI - 910925868386

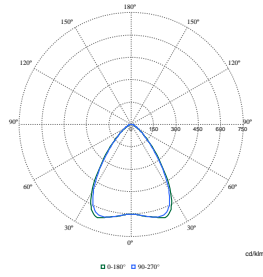

Polar Normal (separate) - SM350CI - 910925868360

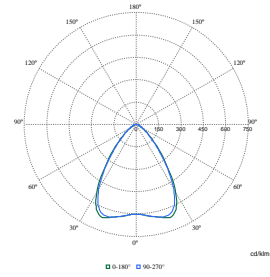

Polar Normal (separate) - SM350CI - 910925868361

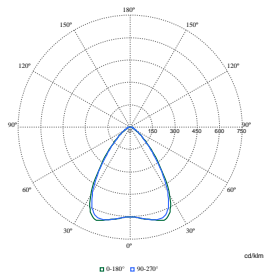

Polar Normal (separate) - SM350CI - 910925868367

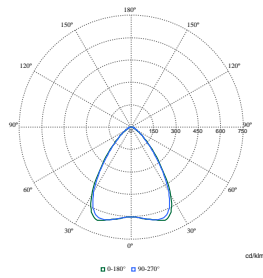

Polar Normal (separate) - SM350CI - 910925868357

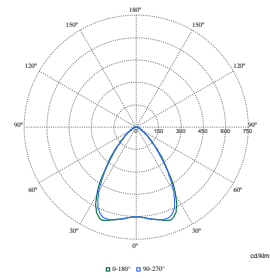

Polar Normal (separate) - SM350CI - 910925868368

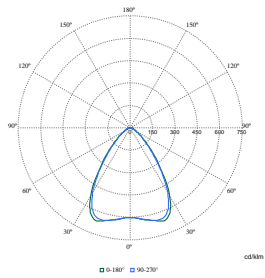

Polar Normal (separate) - SM350CI - 910925868358

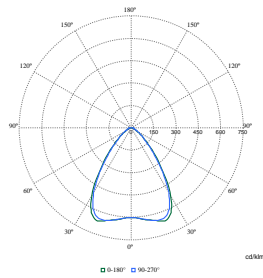

Polar Normal (separate) - SM350CI - 910925868372

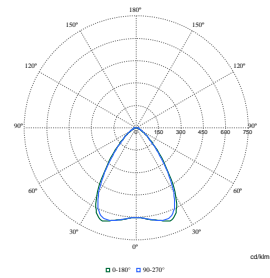

Polar Normal (separate) - SM350CI - 910925868376

Polar Wide Diagrams

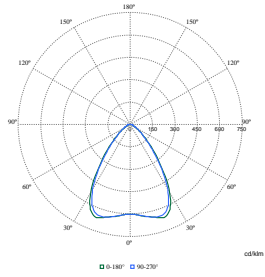

Polar Normal (separate) - SM350CI - 910925868378

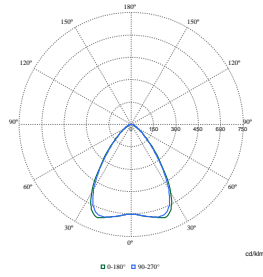

Polar Normal (separate) - SM350CI - 910925868380

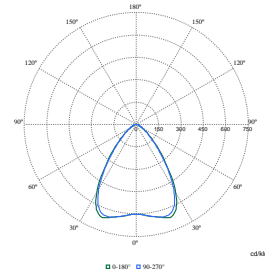

Polar Normal (separate) - SM350CI - 910925868351

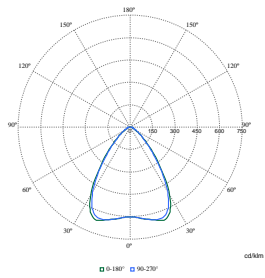

Polar Normal (separate) - SM350CI - 910925868369

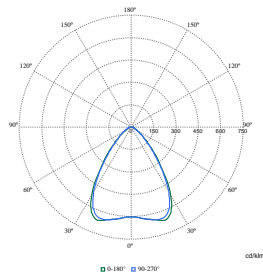

Polar Normal (separate) - SM350CI - 910925868371

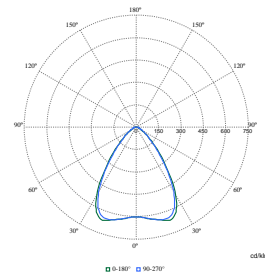

Polar Normal (separate) - SM350CI - 910925868374

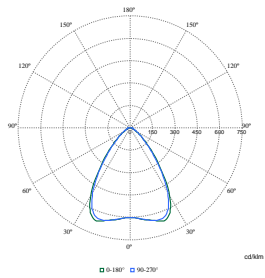

Polar Normal (separate) - SM350CI - 910925868373

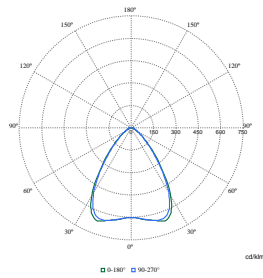

Polar Normal (separate) - SM350CI - 910925868377

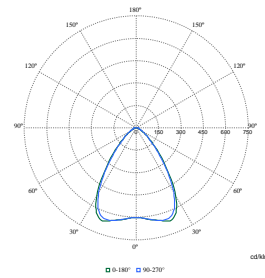

Polar Normal (separate) - SM350CI - 910925868382

KeyLine, povrchové a závesné

Polar Wide Diagrams

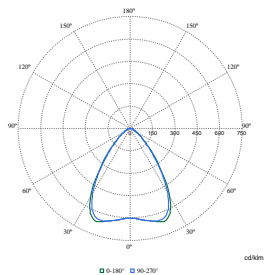

Polar Normal (separate) - SM350CI - 910925868390

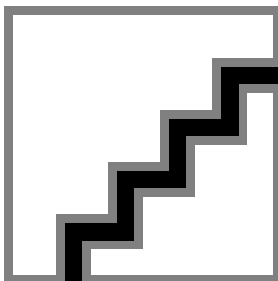

Polar Normal (separate) - null - 910505103701

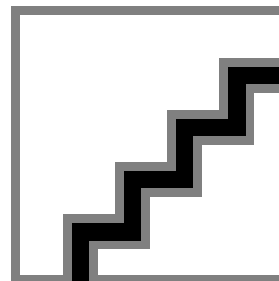

Polar Normal (separate) - null - 910505103702

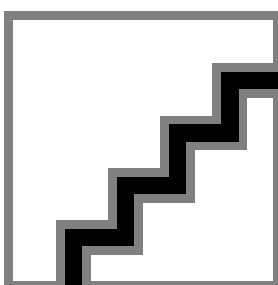

Polar Normal (separate) - null - 910505103703

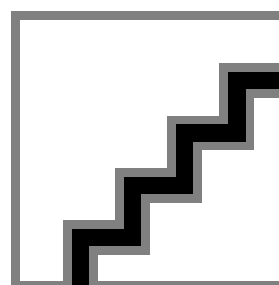

Polar Normal (separate) - null - 910505103704

