



Joustava valojono

KeyLine, pinta-asennettava ja ripustettava

Nykyään monet toimistojen omistajat ja toimistovalaisuksen suunnittelijat suosivat valojonoja. Syy on yksinkertainen: Valojonot tarjoavat tyylikkään minimalistisen ja helposti mukautettavan valaistusratkaisun. Vaihtoehtoja on loputtomasti: valaisimet voidaan asentaa jonoon tai erillisinä valaisimina, valojonoista voidaan tehdä lyhyitä tai pitkiä ja saatavilla on lukuisia erilaisia optiikoita, myös epäsymmetrisiä. KeyLine tarjoaa kaikki nämä edut kilpailukykyiseen hintaan ja täyttää toimistovalaisuksen koskevat vaatimukset. KeyLine on loistava valaisintuoteperhe, jossa on virtaviivainen, minimalistinen muotoilu ja korkea valovirta. KeyLine-valaisimien häikäisytaaso on matala ja valo on miellyttävää silmille, mikä takaa toimistoyhteensopivuuden (UGR19). KeyLine sopii erinomaisesti valojonoon asennettavaksi, mutta se voidaan asentaa myös erillisenä valaisimena, joko ripustettavana tai pinta-asennettavana (lisätarvikkeet on tilattava erikseen). KeyLine-tuotevalikoima tarjoaa rajattomasti mahdollisuuksia. KeyLine-valaisimia on saatavilla eri pituuksilla, väreillä ja valovirroilla. Ne voidaan asentaa suoran valojonon lisäksi vaikkapa L-kirjaimen muotoon. KeyLinen valotehokkuus on jopa 142 lm/W. Energiaa voidaan säästää vieläkin enemmän, jos KeyLine yhdistetään älykkääseen valaistuksenohjausjärjestelmään. KeyLinen erinomainen hintalaatusuhde takaa houkuttelevat kokonaiskustannukset.

Hyödyt

- Toimistoyhteensopiva
- Edulliset kokonaiskustannukset
- Laaja valikoima vaihtoehtoja erilaisiin toimistotiloihin

Ominaisuudet

- Miellyttävä valo, ei häikäise: <UGR19 saatavilla koko tuoteperheelle
- Korkea valovirta, jopa 4 000 lm 1,2 m versiossa
- Interact-yhteensopiva langattomilla liitäntälaitteilla
- Vakiovaihtoehtoja eri pituuksissa ja väreissä sekä eri valovirtavaihtoehtoja
- Voidaan räätälöidä halutunlaiseksi

KeyLine, pinta-asennettava ja ripustettava

Käyttökohteet

- Toimistot
- Vähittäismyymälät
- Oppilaitokset

Rajoitukset ja turvallisuus

- KeyLine-valaisinten suojausluokka on IPX0, eikä sitä ole sellaisenaan suojattu vedeltä. Tämä tulee ottaa huomioon asennuspaikka valittaessa.
- Jos valaisimet altistuvat vedelle, Philips ja Signify eivät voi taata tuotteen turvallisuutta tai virheetöntä toimintaa. Tuotetakuu raukeaa automaattisesti.

Versions



KeyLine L-corner, black



KeyLine L-corner, alu



KeyLine L-corner, white



KeyLine Asymmetric SM531C SPP

Mittapiirros

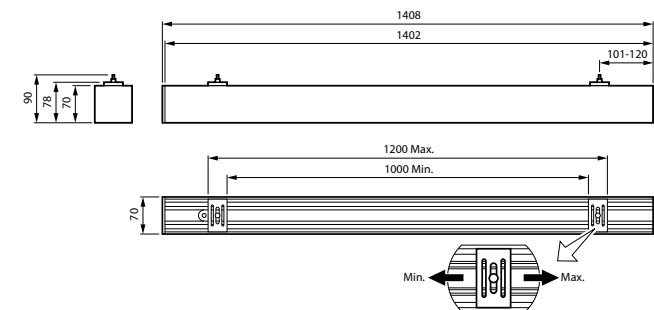
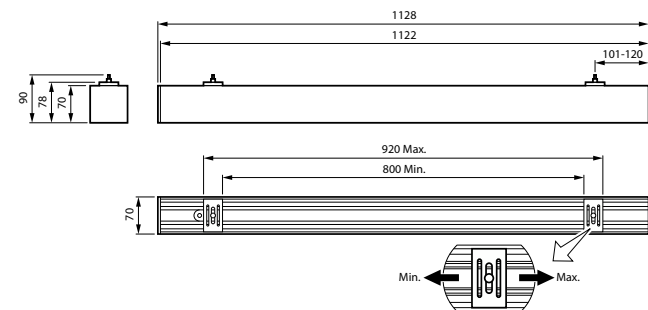
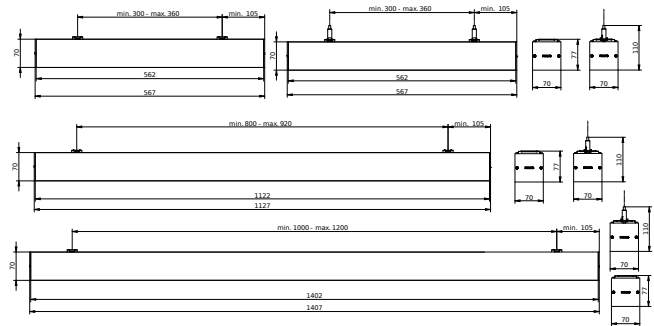
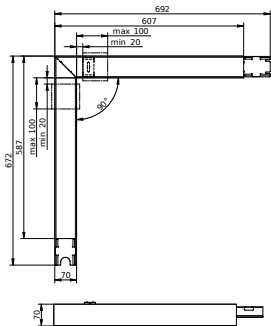

KeyLine, pinta-asennettava ja ripustettava

Tuotetiedot



KeyLine line coupling, alu



KeyLine black with ceiling bracket
accessory for surface mounting

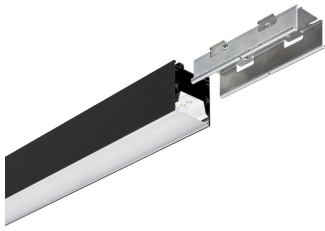

KeyLine black with coupling piece
accessory for line mounting



KeyLine Asymmetric SM531C
detailed



KeyLine_SM350C_WIA_DPP1



KeyLine line configuration, white



KeyLine SM350C, white



KeyLine configuration with L-
corner SM350X

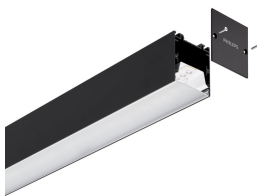

KeyLine black with end-cap
accessory



KeyLine line coupling, white

KeyLine, pinta-asennettava ja ripustettava

Tuotetiedot



KeyLine alu with suspension set for suspended mounting

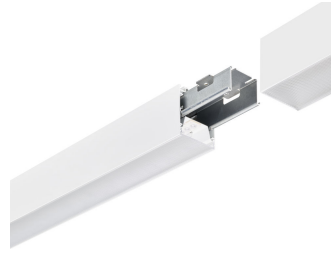

KeyLine white line coupling with coupling piece accessory



KeyLine_SM350C_WIA_DPP3



KeyLine alu with end-cap accessory



KeyLine white with coupling piece accessory for line mounting



KeyLine structured optics UGR19 (PCS)



KeyLine line coupling, black



KeyLine SM350C, alu

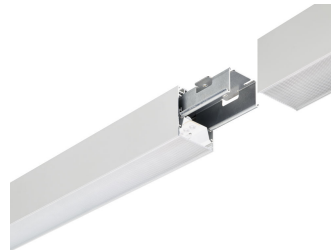

KeyLine alu line coupling with coupling piece accessory

KeyLine, pinta-asennettava ja ripustettava

Tuotetiedot



KeyLine line configuration, black



KeyLine alu with ceiling bracket accessory for surface mounting



KeyLine white with suspension set for suspended mounting



KeyLine white with ceiling bracket accessory for surface mounting



KeyLine white with end-cap accessory



KeyLine alu with coupling piece accessory for line mounting



KeyLine SM350C, black

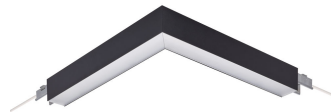

KeyLine L-corner, black

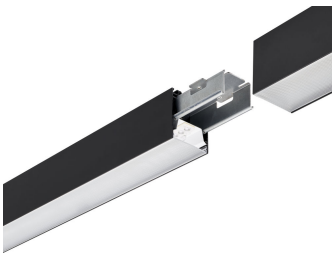

KeyLine black line coupling with coupling piece accessory



KeyLine black with suspension set for suspended mounting



KeyLine_SM350C_WIA_DPP2

KeyLine, pinta-asennettava ja ripustettava

Tuotetiedot

KeyLine L-corner, alu



KeyLine L-corner, white

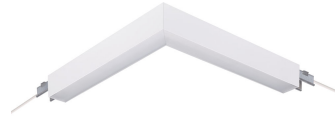

Yleistä tietoa

Liitäntälaitte sisältyy toimitukseen	Kyllä
Liitäntälaitteiden lukumäärä	1 yksikkö
Huoltotunniste	Kyllä

Valaistuksen tekniset tiedot

Värintoistoindeksi (CRI)	>80
--------------------------	-----

Käyttö- ja sähkö tiedot

Suojausluokka IEC	Suojausluokka I
Verkkotaajuus	50 to 60 Hz

Mekaaniset tiedot ja runko

Iskunkestävyyssluokka	IK06
Suojausluokan koodi	IP20

Merkinnät ja luokitukset

Käyttölämpötila-alue	+10...+35 °C
CE-merkintä	Kyllä
ENEC-merkintä	ENEC-merkintä
Hehkulankatesti	Lämpötila 650 °C, kesto 30 s
Stroboskooppi-ilmiön arvo (SVM)	0,4

Suorituskyky alussa (IEC-yhteensopiva)

Valovirran toleranssi	+/-10%
-----------------------	--------

Yleistä tietoa

Order Code	Full Product Name	Valonlähde vaihdettavissa
910925868390	SM350X 27S/840 PSD PCS N BK	Ei
910925868378	SM350C 34S/840 PSU PCS L1500 BK	Ei
910925868381	SM350C 50S/840 PSU PCS L1500 BK	Ei
910925868384	SM350C 34S/840 PSD PCS L1500 BK	Ei
910925868387	SM350C 50S/840 PSD PCS L1500 BK	Ei
910925868303	SM350C 27S/840 PSU PCS L1200 ALU	Ei
910925868353	SM350C 40S/840 PSU PCS L1200 ALU	Ei
910925868356	SM350C 27S/840 PSD PCS L1200 ALU	Ei
910925868359	SM350C 40S/840 PSD PCS L1200 ALU	Ei
910925868368	SM350C 27S/830 PSU PCS L1200 ALU	Ei
910925868370	SM350C 40S/830 PSU PCS L1200 ALU	Ei
910925868372	SM350C 27S/830 PSD PCS L1200 ALU	Ei
910925868374	SM350C 40S/830 PSD PCS L1200 ALU	Ei
910925868388	SM350X 27S/840 PSD L60L60 PCS ALU	Ei
910925868376	SM350C 34S/840 PSU PCS L1500 ALU	Ei
910925868379	SM350C 50S/840 PSU PCS L1500 ALU	Ei
910925868382	SM350C 34S/840 PSD PCS L1500 ALU	Ei
910925868385	SM350C 50S/840 PSD PCS L1500 ALU	Ei
910925868377	SM350C 34S/840 PSU PCS L1500 WH	Ei
910925868380	SM350C 50S/840 PSU PCS L1500 WH	Ei
910925868383	SM350C 34S/840 PSD PCS L1500 WH	Ei
910925868386	SM350C 50S/840 PSD PCS L1500 WH	Ei
910925868362	SM350C 27S/840 WIA PCS L1200 ALU	Ei
910925868363	SM350C 27S/840 WIA PCS L1200 WH	Ei
910925868364	SM350C 27S/840 WIA PCS L1200 BK	Ei
910925868365	SM350C 40S/840 WIA PCS L1200 ALU	Ei
910925868366	SM350C 40S/840 WIA PCS L1200 WH	Ei
910925868367	SM350C 40S/840 WIA PCS L1200 BK	Ei
910925868351	SM350C 27S/840 PSU PCS L1200 WH	Ei
910925868354	SM350C 40S/840 PSU PCS L1200 WH	Ei
910925868357	SM350C 27S/840 PSD PCS L1200 WH	Ei
910925868360	SM350C 40S/840 PSD PCS L1200 WH	Ei
910925868369	SM350C 27S/830 PSU PCS L1200 WH	Ei
910925868371	SM350C 40S/830 PSU PCS L1200 WH	Ei
910925868373	SM350C 27S/830 PSD PCS L1200 WH	Ei
910925868375	SM350C 40S/830 PSD PCS L1200 WH	Ei
910925868352	SM350C 27S/840 PSU PCS L1200 BK	Ei
910925868355	SM350C 40S/840 PSU PCS L1200 BK	Ei
910925868358	SM350C 27S/840 PSD PCS L1200 BK	Ei

KeyLine, pinta-asennettava ja ripustettava

Order Code	Full Product Name	Valonlähde vaihdettavissa
910925868361	SM350C 40S/840 PSD PCS L1200 BK	Ei
910925868389	SM350X 27S/840 PSD L60L60 PCS WH	Ei
910505103701	SM351C 40S/840 PSU A PCS L1200 WH	-
910505103702	SM351C 40S/840 PSD A PCS L1200 WH	-
910505103703	SM351C 50S/840 PSU A PCS L1500 WH	-
910505103704	SM351C 50S/840 PSD A PCS L1500 WH	-

Valaistuksen tekniset tiedot (1/2)

Order Code	Full				
	Product Name	Valonlähteen keilakulma	Väriämpötila (nim.)	Valotehokkuus (nimellinen)	Valovirta
910925868390	SM350X 27S/840 PSD PCS N BK	120 °	4000 K	135 lm/W	2 700 lm
910925868378	SM350C 34S/840 PSU PCS L1500 BK	120 °	4000 K	142 lm/W	3 400 lm
910925868381	SM350C 50S/840 PSU PCS L1500 BK	120 °	4000 K	135 lm/W	5 000 lm
910925868384	SM350C 34S/840 PSD PCS L1500 BK	120 °	4000 K	136 lm/W	3 400 lm
910925868387	SM350C 50S/840 PSD PCS L1500 BK	120 °	4000 K	135 lm/W	5 000 lm
910925868303	SM350C 27S/840 PSU PCS L1200 ALU	120 °	4000 K	138 lm/W	2 700 lm
910925868353	SM350C 40S/840 PSU PCS L1200 ALU	120 °	4000 K	133 lm/W	4 000 lm
910925868356	SM350C 27S/840 PSD PCS L1200 ALU	120 °	4000 K	135 lm/W	2 700 lm
910925868359	SM350C 40S/840 PSD PCS L1200 ALU	120 °	4000 K	133 lm/W	4 000 lm
910925868368	SM350C 27S/830 PSU PCS L1200 ALU	120 °	3000 K	132 lm/W	2 700 lm

Order Code	Full				
	Product Name	Valonlähteen keilakulma	Väriämpötila (nim.)	Valotehokkuus (nimellinen)	Valovirta
910925868370	SM350C 40S/830 PSU PCS L1200 ALU	120 °	3000 K	133 lm/W	4 000 lm
910925868372	SM350C 27S/830 PSD PCS L1200 ALU	120 °	3000 K	135 lm/W	2 700 lm
910925868374	SM350C 40S/830 PSD PCS L1200 ALU	120 °	3000 K	129 lm/W	4 000 lm
910925868388	SM350X 27S/840 PSD L60L60 PCS ALU	120 °	4000 K	135 lm/W	2 700 lm
910925868376	SM350C 34S/840 PSU PCS L1500 ALU	120 °	4000 K	142 lm/W	3 400 lm
910925868379	SM350C 50S/840 PSU PCS L1500 ALU	120 °	4000 K	135 lm/W	5 000 lm
910925868382	SM350C 34S/840 PSD PCS L1500 ALU	120 °	4000 K	136 lm/W	3 400 lm
910925868385	SM350C 50S/840 PSD PCS L1500 ALU	120 °	4000 K	135 lm/W	5 000 lm
910925868377	SM350C 34S/840 PSU PCS L1500 WH	120 °	4000 K	142 lm/W	3 400 lm
910925868380	SM350C 50S/840	120 °	4000 K	135 lm/W	5 000 lm

KeyLine, pinta-asennettava ja ripustettava

Order Code	Full				
	Product Name	Valonlähteen keilakulma	Väriämpötila (nim.)	Valotehokkuus (nimellinen)	Valovirta
	PSU PCS L1500 WH				
910925868383	SM350C 34S/840 PSD PCS L1500 WH	120 °	4000 K	136 lm/W	3 400 lm
910925868386	SM350C 50S/840 PSD PCS L1500 WH	120 °	4000 K	135 lm/W	5 000 lm
910925868362	SM350C 27S/840 WIA PCS L1200 ALU	120 °	4000 K	138 lm/W	2 700 lm
910925868363	SM350C 27S/840 WIA PCS L1200 WH	120 °	4000 K	138 lm/W	2 700 lm
910925868364	SM350C 27S/840 WIA PCS L1200 BK	120 °	4000 K	138 lm/W	2 700 lm
910925868365	SM350C 40S/840 WIA PCS L1200 ALU	120 °	4000 K	133 lm/W	4 000 lm
910925868366	SM350C 40S/840 WIA PCS L1200 WH	120 °	4000 K	133 lm/W	4 000 lm
910925868367	SM350C 40S/840 WIA PCS L1200 BK	120 °	4000 K	133 lm/W	4 000 lm
910925868351	SM350C 27S/840 PSU PCS L1200 WH	120 °	4000 K	138 lm/W	2 700 lm
910925868354	SM350C 40S/840 PSU PCS L1200 WH	120 °	4000 K	133 lm/W	4 000 lm
910925868357	SM350C 27S/840 PSD PCS L1200 WH	120 °	4000 K	135 lm/W	2 700 lm
910925868360	SM350C 40S/840 PSD PCS L1200 WH	120 °	4000 K	133 lm/W	4 000 lm
910925868369	SM350C 27S/830	120 °	3000 K	132 lm/W	2 700 lm

Order Code	Full				
	Product Name	Valonlähteen keilakulma	Väriämpötila (nim.)	Valotehokkuus (nimellinen)	Valovirta
	PSU PCS L1200 WH				
910925868371	SM350C 40S/830 PSU PCS L1200 WH	120 °	3000 K	133 lm/W	4 000 lm
910925868373	SM350C 27S/830 PSD PCS L1200 WH	120 °	3000 K	135 lm/W	2 700 lm
910925868375	SM350C 40S/830 PSD PCS L1200 WH	120 °	3000 K	129 lm/W	4 000 lm
910925868352	SM350C 27S/840 PSU PCS L1200 BK	120 °	4000 K	138 lm/W	2 700 lm
910925868355	SM350C 40S/840 PSU PCS L1200 BK	120 °	4000 K	133 lm/W	4 000 lm
910925868358	SM350C 27S/840 PSD PCS L1200 BK	120 °	4000 K	135 lm/W	2 700 lm
910925868361	SM350C 40S/840 PSD PCS L1200 BK	120 °	4000 K	133 lm/W	4 000 lm
910925868389	SM350X 27S/840 PSD L60L60 PCS WH	120 °	4000 K	135 lm/W	2 700 lm
910505103701	SM351C 40S/840 PSU A PCS L1200 WH	-	4000 K	133 lm/W	4 000 lm
910505103702	SM351C 40S/840 PSD A PCS L1200 WH	-	4000 K	133 lm/W	4 000 lm
910505103703	SM351C 50S/840 PSU A PCS L1500 WH	-	4000 K	135 lm/W	5 000 lm
910505103704	SM351C 50S/840	-	4000 K	132 lm/W	5 000 lm

KeyLine, pinta-asennettava ja ripustettava

Order Code	Full Product Name	Valonlähteen keilakulma	Väriämpötila (nim.)	Valotehokkuus (nimellinen)	Valovirta
	PSD A PCS				
	L1500 WH				

Valaistuksen tekniset tiedot (2/2)

Order Code	Full Product Name	Optiikan tyyppi
910925868390	SM350X 27S/840 PSD PCS N BK	Keskileveä valokeila
910925868378	SM350C 34S/840 PSU PCS L1500 BK	Keskileveä valokeila
910925868381	SM350C 50S/840 PSU PCS L1500 BK	Keskileveä valokeila
910925868384	SM350C 34S/840 PSD PCS L1500 BK	Keskileveä valokeila
910925868387	SM350C 50S/840 PSD PCS L1500 BK	Keskileveä valokeila
910925868303	SM350C 27S/840 PSU PCS L1200 ALU	Keskileveä valokeila
910925868353	SM350C 40S/840 PSU PCS L1200 ALU	Keskileveä valokeila
910925868356	SM350C 27S/840 PSD PCS L1200 ALU	Keskileveä valokeila
910925868359	SM350C 40S/840 PSD PCS L1200 ALU	Keskileveä valokeila
910925868368	SM350C 27S/830 PSU PCS L1200 ALU	Keskileveä valokeila
910925868370	SM350C 40S/830 PSU PCS L1200 ALU	Keskileveä valokeila
910925868372	SM350C 27S/830 PSD PCS L1200 ALU	Keskileveä valokeila
910925868374	SM350C 40S/830 PSD PCS L1200 ALU	Keskileveä valokeila
910925868388	SM350X 27S/840 PSD L60L60 PCS ALU	Keskileveä valokeila
910925868376	SM350C 34S/840 PSU PCS L1500 ALU	Keskileveä valokeila
910925868379	SM350C 50S/840 PSU PCS L1500 ALU	Keskileveä valokeila
910925868382	SM350C 34S/840 PSD PCS L1500 ALU	Keskileveä valokeila
910925868385	SM350C 50S/840 PSD PCS L1500 ALU	Keskileveä valokeila
910925868377	SM350C 34S/840 PSU PCS L1500 WH	Keskileveä valokeila
910925868380	SM350C 50S/840 PSU PCS L1500 WH	Keskileveä valokeila
910925868383	SM350C 34S/840 PSD PCS L1500 WH	Keskileveä valokeila
910925868386	SM350C 50S/840 PSD PCS L1500 WH	Keskileveä valokeila
910925868362	SM350C 27S/840 WIA PCS L1200 ALU	Keskileveä valokeila

Order Code	Full Product Name	Optiikan tyyppi
910925868363	SM350C 27S/840 WIA PCS L1200 WH	Keskileveä valokeila
910925868364	SM350C 27S/840 WIA PCS L1200 BK	Keskileveä valokeila
910925868365	SM350C 40S/840 WIA PCS L1200 ALU	Keskileveä valokeila
910925868366	SM350C 40S/840 WIA PCS L1200 WH	Keskileveä valokeila
910925868367	SM350C 40S/840 WIA PCS L1200 BK	Keskileveä valokeila
910925868351	SM350C 27S/840 PSU PCS L1200 WH	Keskileveä valokeila
910925868354	SM350C 40S/840 PSU PCS L1200 WH	Keskileveä valokeila
910925868357	SM350C 27S/840 PSD PCS L1200 WH	Keskileveä valokeila
910925868360	SM350C 40S/840 PSD PCS L1200 WH	Keskileveä valokeila
910925868369	SM350C 27S/830 PSU PCS L1200 WH	Keskileveä valokeila
910925868371	SM350C 40S/830 PSU PCS L1200 WH	Keskileveä valokeila
910925868373	SM350C 27S/830 PSD PCS L1200 WH	Keskileveä valokeila
910925868375	SM350C 40S/830 PSD PCS L1200 WH	Keskileveä valokeila
910925868352	SM350C 27S/840 PSU PCS L1200 BK	Keskileveä valokeila
910925868355	SM350C 40S/840 PSU PCS L1200 BK	Keskileveä valokeila
910925868358	SM350C 27S/840 PSD PCS L1200 BK	Keskileveä valokeila
910925868361	SM350C 40S/840 PSD PCS L1200 BK	Keskileveä valokeila
910925868389	SM350X 27S/840 PSD L60L60 PCS WH	Keskileveä valokeila
910505103701	SM351C 40S/840 PSU A PCS L1200 WH	Epäsymmetrinen keilakulma
910505103702	SM351C 40S/840 PSD A PCS L1200 WH	Epäsymmetrinen keilakulma
910505103703	SM351C 50S/840 PSU A PCS L1500 WH	Epäsymmetrinen keilakulma
910505103704	SM351C 50S/840 PSD A PCS L1500 WH	Epäsymmetrinen keilakulma

Käyttö- ja sähkö tiedot

Order Code	Full Product Name	Tulojännite	Tehonkulutus	Soveltuu satunnaiseen kytkentään
910925868390	SM350X 27S/840 PSD PCS N BK	220–240 V	21 W	Ei
910925868378	SM350C 34S/840 PSU PCS L1500 BK	220–240 V	25 W	Ei
910925868381	SM350C 50S/840 PSU PCS L1500 BK	220–240 V	36,5 W	Ei
910925868384	SM350C 34S/840 PSD PCS L1500 BK	220–240 V	26 W	Ei
910925868387	SM350C 50S/840 PSD PCS L1500 BK	220–240 V	38 W	Ei
910925868303	SM350C 27S/840 PSU PCS L1200 ALU	220–240 V	20,5 W	Ei
910925868353	SM350C 40S/840 PSU PCS L1200 ALU	220–240 V	30 W	Ei

Order Code	Full Product Name	Tulojännite	Tehonkulutus	Soveltuu satunnaiseen kytkentään
910925868356	SM350C 27S/840 PSD PCS L1200 ALU	220–240 V	21 W	Ei
910925868359	SM350C 40S/840 PSD PCS L1200 ALU	220–240 V	31 W	Ei
910925868368	SM350C 27S/830 PSU PCS L1200 ALU	220–240 V	20,5 W	Ei
910925868370	SM350C 40S/830 PSU PCS L1200 ALU	220–240 V	30 W	Ei
910925868372	SM350C 27S/830 PSD PCS L1200 ALU	220–240 V	21 W	Ei
910925868374	SM350C 40S/830 PSD PCS L1200 ALU	220–240 V	31 W	Ei
910925868388	SM350X 27S/840 PSD L60L60 PCS ALU	220–240 V	21 W	Ei

KeyLine, pinta-asennettava ja ripustettava

Order Code	Full Product Name	Tulojännite	Tehonkulutus	Soveltuu satunnaiseen kytkentään
910925868376	SM350C 34S/840 PSU PCS L1500 ALU	220–240 V	25 W	Ei
910925868379	SM350C 50S/840 PSU PCS L1500 ALU	220–240 V	36,5 W	Ei
910925868382	SM350C 34S/840 PSD PCS L1500 ALU	220–240 V	26 W	Ei
910925868385	SM350C 50S/840 PSD PCS L1500 ALU	220–240 V	38 W	Ei
910925868377	SM350C 34S/840 PSU PCS L1500 WH	220–240 V	25 W	Ei
910925868380	SM350C 50S/840 PSU PCS L1500 WH	220–240 V	36,5 W	Ei
910925868383	SM350C 34S/840 PSD PCS L1500 WH	220–240 V	26 W	Ei
910925868386	SM350C 50S/840 PSD PCS L1500 WH	220–240 V	38 W	Ei
910925868362	SM350C 27S/840 WIA PCS L1200 ALU	220–240 V	20,5 W	Ei
910925868363	SM350C 27S/840 WIA PCS L1200 WH	220–240 V	20,5 W	Ei
910925868364	SM350C 27S/840 WIA PCS L1200 BK	220–240 V	20,5 W	Ei
910925868365	SM350C 40S/840 WIA PCS L1200 ALU	220–240 V	30 W	Ei
910925868366	SM350C 40S/840 WIA PCS L1200 WH	220–240 V	30 W	Ei
910925868367	SM350C 40S/840 WIA PCS L1200 BK	220–240 V	30 W	Ei
910925868351	SM350C 27S/840 PSU PCS L1200 WH	220–240 V	20,5 W	Ei
910925868354	SM350C 40S/840 PSU PCS L1200 WH	220–240 V	30 W	Ei

Order Code	Full Product Name	Tulojännite	Tehonkulutus	Soveltuu satunnaiseen kytkentään
910925868357	SM350C 27S/840 PSD PCS L1200 WH	220–240 V	21 W	Ei
910925868360	SM350C 40S/840 PSD PCS L1200 WH	220–240 V	31 W	Ei
910925868369	SM350C 27S/830 PSU PCS L1200 WH	220–240 V	20,5 W	Ei
910925868371	SM350C 40S/830 PSU PCS L1200 WH	220–240 V	30 W	Ei
910925868373	SM350C 27S/830 PSD PCS L1200 WH	220–240 V	21 W	Ei
910925868375	SM350C 40S/830 PSD PCS L1200 WH	220–240 V	31 W	Ei
910925868352	SM350C 27S/840 PSU PCS L1200 BK	220–240 V	20,5 W	Ei
910925868355	SM350C 40S/840 PSU PCS L1200 BK	220–240 V	30 W	Ei
910925868358	SM350C 27S/840 PSD PCS L1200 BK	220–240 V	21 W	Ei
910925868361	SM350C 40S/840 PSD PCS L1200 BK	220–240 V	31 W	Ei
910925868389	SM350X 27S/840 PSD L60L60 PCS WH	220–240 V	21 W	Ei
910505103701	SM351C 40S/840 PSU A PCS L1200 WH	220–240 V	30 W	Ei sovellettavissa
910505103702	SM351C 40S/840 PSD A PCS L1200 WH	220–240 V	31 W	Ei sovellettavissa
910505103703	SM351C 50S/840 PSU A PCS L1500 WH	220–240 V	37 W	Ei sovellettavissa
910505103704	SM351C 50S/840 PSD A PCS L1500 WH	220–240 V	38 W	Ei sovellettavissa

Ohjausjärjestelmät ja himmennys

Order Code	Full Product Name	Himmennettävä	Enimmäishimmennystaso
910925868390	SM350X 27S/840 PSD PCS N BK	Kyllä	1%
910925868378	SM350C 34S/840 PSU PCS L1500 BK	Ei	Ei sovellettavissa
910925868381	SM350C 50S/840 PSU PCS L1500 BK	Ei	Ei sovellettavissa
910925868384	SM350C 34S/840 PSD PCS L1500 BK	Kyllä	1%
910925868387	SM350C 50S/840 PSD PCS L1500 BK	Kyllä	1%
910925868303	SM350C 27S/840 PSU PCS L1200 ALU	Ei	Ei sovellettavissa
910925868353	SM350C 40S/840 PSU PCS L1200 ALU	Ei	Ei sovellettavissa

Order Code	Full Product Name	Himmennettävä	Enimmäishimmennystaso
910925868356	SM350C 27S/840 PSD PCS L1200 ALU	Kyllä	1%
910925868359	SM350C 40S/840 PSD PCS L1200 ALU	Kyllä	1%
910925868368	SM350C 27S/830 PSU PCS L1200 ALU	Ei	Ei sovellettavissa
910925868370	SM350C 40S/830 PSU PCS L1200 ALU	Ei	Ei sovellettavissa
910925868372	SM350C 27S/830 PSD PCS L1200 ALU	Kyllä	1%
910925868374	SM350C 40S/830 PSD PCS L1200 ALU	Kyllä	1%
910925868388	SM350X 27S/840 PSD L60L60 PCS ALU	Kyllä	1%

KeyLine, pinta-asennettava ja ripustettava

Order Code	Full Product Name	Himmennettävä	Enimmäishimmennystaso
910925868376	SM350C 34S/840 PSU PCS L1500 ALU	Ei	Ei sovellettavissa
910925868379	SM350C 50S/840 PSU PCS L1500 ALU	Ei	Ei sovellettavissa
910925868382	SM350C 34S/840 PSD PCS L1500 ALU	Kyllä	1%
910925868385	SM350C 50S/840 PSD PCS L1500 ALU	Kyllä	1%
910925868377	SM350C 34S/840 PSU PCS L1500 WH	Ei	Ei sovellettavissa
910925868380	SM350C 50S/840 PSU PCS L1500 WH	Ei	Ei sovellettavissa
910925868383	SM350C 34S/840 PSD PCS L1500 WH	Kyllä	1%
910925868386	SM350C 50S/840 PSD PCS L1500 WH	Kyllä	1%
910925868362	SM350C 27S/840 WIA PCS L1200 ALU	Ei	1%
910925868363	SM350C 27S/840 WIA PCS L1200 WH	Ei	1%
910925868364	SM350C 27S/840 WIA PCS L1200 BK	Ei	1%
910925868365	SM350C 40S/840 WIA PCS L1200 ALU	Ei	1%
910925868366	SM350C 40S/840 WIA PCS L1200 WH	Ei	1%
910925868367	SM350C 40S/840 WIA PCS L1200 BK	Ei	1%
910925868351	SM350C 27S/840 PSU PCS L1200 WH	Ei	Ei sovellettavissa
910925868354	SM350C 40S/840 PSU PCS L1200 WH	Ei	Ei sovellettavissa

Order Code	Full Product Name	Himmennettävä	Enimmäishimmennystaso
910925868357	SM350C 27S/840 PSD PCS L1200 WH	Kyllä	1%
910925868360	SM350C 40S/840 PSD PCS L1200 WH	Kyllä	1%
910925868369	SM350C 27S/830 PSU PCS L1200 WH	Ei	Ei sovellettavissa
910925868371	SM350C 40S/830 PSU PCS L1200 WH	Ei	Ei sovellettavissa
910925868373	SM350C 27S/830 PSD PCS L1200 WH	Kyllä	1%
910925868375	SM350C 40S/830 PSD PCS L1200 WH	Kyllä	1%
910925868352	SM350C 27S/840 PSU PCS L1200 BK	Ei	Ei sovellettavissa
910925868355	SM350C 40S/840 PSU PCS L1200 BK	Ei	Ei sovellettavissa
910925868358	SM350C 27S/840 PSD PCS L1200 BK	Kyllä	1%
910925868361	SM350C 40S/840 PSD PCS L1200 BK	Kyllä	1%
910925868389	SM350X 27S/840 PSD L60L60 PCS WH	Kyllä	1%
910505103701	SM351C 40S/840 PSU A PCS L1200 WH	Ei	Ei sovellettavissa
910505103702	SM351C 40S/840 PSD A PCS L1200 WH	-	1%
910505103703	SM351C 50S/840 PSU A PCS L1500 WH	Ei	Ei sovellettavissa
910505103704	SM351C 50S/840 PSD A PCS L1500 WH	-	1%

Mekaaniset tiedot ja runko

Order Code	Full Product Name	Rungon väri
910925868390	SM350X 27S/840 PSD PCS N BK	Musta
910925868378	SM350C 34S/840 PSU PCS L1500 BK	Musta
910925868381	SM350C 50S/840 PSU PCS L1500 BK	Musta
910925868384	SM350C 34S/840 PSD PCS L1500 BK	Musta
910925868387	SM350C 50S/840 PSD PCS L1500 BK	Musta
910925868303	SM350C 27S/840 PSU PCS L1200 ALU	Alumiini
910925868353	SM350C 40S/840 PSU PCS L1200 ALU	Alumiini
910925868356	SM350C 27S/840 PSD PCS L1200 ALU	Alumiini
910925868359	SM350C 40S/840 PSD PCS L1200 ALU	Alumiini
910925868368	SM350C 27S/830 PSU PCS L1200 ALU	Alumiini
910925868370	SM350C 40S/830 PSU PCS L1200 ALU	Alumiini
910925868372	SM350C 27S/830 PSD PCS L1200 ALU	Alumiini
910925868374	SM350C 40S/830 PSD PCS L1200 ALU	Alumiini
910925868388	SM350X 27S/840 PSD L60L60 PCS ALU	Alumiini
910925868376	SM350C 34S/840 PSU PCS L1500 ALU	Alumiini
910925868379	SM350C 50S/840 PSU PCS L1500 ALU	Alumiini

Order Code	Full Product Name	Rungon väri
910925868382	SM350C 34S/840 PSD PCS L1500 ALU	Alumiini
910925868385	SM350C 50S/840 PSD PCS L1500 ALU	Alumiini
910925868377	SM350C 34S/840 PSU PCS L1500 WH	Valkoinen
910925868380	SM350C 50S/840 PSU PCS L1500 WH	Valkoinen
910925868383	SM350C 34S/840 PSD PCS L1500 WH	Valkoinen
910925868386	SM350C 50S/840 PSD PCS L1500 WH	Valkoinen
910925868362	SM350C 27S/840 WIA PCS L1200 ALU	Alumiini
910925868363	SM350C 27S/840 WIA PCS L1200 WH	Valkoinen
910925868364	SM350C 27S/840 WIA PCS L1200 BK	Musta
910925868365	SM350C 40S/840 WIA PCS L1200 ALU	Alumiini
910925868366	SM350C 40S/840 WIA PCS L1200 WH	Valkoinen
910925868367	SM350C 40S/840 WIA PCS L1200 BK	Musta
910925868351	SM350C 27S/840 PSU PCS L1200 WH	Valkoinen
910925868354	SM350C 40S/840 PSU PCS L1200 WH	Valkoinen
910925868357	SM350C 27S/840 PSD PCS L1200 WH	Valkoinen
910925868360	SM350C 40S/840 PSD PCS L1200 WH	Valkoinen

KeyLine, pinta-asennettava ja ripustettava

Order Code	Full Product Name	Rungon väri
910925868369	SM350C 27S/830 PSU PCS L1200 WH	Valkoinen
910925868371	SM350C 40S/830 PSU PCS L1200 WH	Valkoinen
910925868373	SM350C 27S/830 PSD PCS L1200 WH	Valkoinen
910925868375	SM350C 40S/830 PSD PCS L1200 WH	Valkoinen
910925868352	SM350C 27S/840 PSU PCS L1200 BK	Musta
910925868355	SM350C 40S/840 PSU PCS L1200 BK	Musta
910925868358	SM350C 27S/840 PSD PCS L1200 BK	Musta

Order Code	Full Product Name	Rungon väri
910925868361	SM350C 40S/840 PSD PCS L1200 BK	Musta
910925868389	SM350X 27S/840 PSD L60L60 PCS WH	Valkoinen
910505103701	SM351C 40S/840 PSU A PCS L1200 WH	Valkoinen
910505103702	SM351C 40S/840 PSD A PCS L1200 WH	Valkoinen
910505103703	SM351C 50S/840 PSU A PCS L1500 WH	Valkoinen
910505103704	SM351C 50S/840 PSD A PCS L1500 WH	Valkoinen

Hätätilakäyttö

Order Code	Full Product Name	Keskusakustollinen turvavalaistus
910925868390	SM350X 27S/840 PSD PCS N BK	-
910925868378	SM350C 34S/840 PSU PCS L1500 BK	-
910925868381	SM350C 50S/840 PSU PCS L1500 BK	-
910925868384	SM350C 34S/840 PSD PCS L1500 BK	-
910925868387	SM350C 50S/840 PSD PCS L1500 BK	-
910925868303	SM350C 27S/840 PSU PCS L1200 ALU	-
910925868353	SM350C 40S/840 PSU PCS L1200 ALU	-
910925868356	SM350C 27S/840 PSD PCS L1200 ALU	-
910925868359	SM350C 40S/840 PSD PCS L1200 ALU	-
910925868368	SM350C 27S/830 PSU PCS L1200 ALU	-
910925868370	SM350C 40S/830 PSU PCS L1200 ALU	-
910925868372	SM350C 27S/830 PSD PCS L1200 ALU	-
910925868374	SM350C 40S/830 PSD PCS L1200 ALU	-
910925868388	SM350X 27S/840 PSD L60L60 PCS ALU	-
910925868376	SM350C 34S/840 PSU PCS L1500 ALU	-
910925868379	SM350C 50S/840 PSU PCS L1500 ALU	-
910925868382	SM350C 34S/840 PSD PCS L1500 ALU	-
910925868385	SM350C 50S/840 PSD PCS L1500 ALU	-
910925868377	SM350C 34S/840 PSU PCS L1500 WH	-
910925868380	SM350C 50S/840 PSU PCS L1500 WH	-
910925868383	SM350C 34S/840 PSD PCS L1500 WH	-
910925868386	SM350C 50S/840 PSD PCS L1500 WH	-
910925868362	SM350C 27S/840 WIA PCS L1200 ALU	-

Order Code	Full Product Name	Keskusakustollinen turvavalaistus
910925868363	SM350C 27S/840 WIA PCS L1200 WH	-
910925868364	SM350C 27S/840 WIA PCS L1200 BK	-
910925868365	SM350C 40S/840 WIA PCS L1200 ALU	-
910925868366	SM350C 40S/840 WIA PCS L1200 WH	-
910925868367	SM350C 40S/840 WIA PCS L1200 BK	-
910925868351	SM350C 27S/840 PSU PCS L1200 WH	-
910925868354	SM350C 40S/840 PSU PCS L1200 WH	-
910925868357	SM350C 27S/840 PSD PCS L1200 WH	-
910925868360	SM350C 40S/840 PSD PCS L1200 WH	-
910925868369	SM350C 27S/830 PSU PCS L1200 WH	-
910925868371	SM350C 40S/830 PSU PCS L1200 WH	-
910925868373	SM350C 27S/830 PSD PCS L1200 WH	-
910925868375	SM350C 40S/830 PSD PCS L1200 WH	-
910925868352	SM350C 27S/840 PSU PCS L1200 BK	-
910925868355	SM350C 40S/840 PSU PCS L1200 BK	-
910925868358	SM350C 27S/840 PSD PCS L1200 BK	-
910925868361	SM350C 40S/840 PSD PCS L1200 BK	-
910925868389	SM350X 27S/840 PSD L60L60 PCS WH	-
910505103701	SM351C 40S/840 PSU A PCS L1200 WH	Ei
910505103702	SM351C 40S/840 PSD A PCS L1200 WH	Ei
910505103703	SM351C 50S/840 PSU A PCS L1500 WH	Ei
910505103704	SM351C 50S/840 PSD A PCS L1500 WH	Ei

Merkinnät ja luokitukset

Order Code	Full Product Name	Syttövyysluokka	Välkyntäarvo (PstLM)
910925868390	SM350X 27S/840 PSD PCS N BK	Soveltuu asennettavaksi normaalisti syttyville pinnoille	1
910925868378	SM350C 34S/840 PSU PCS L1500 BK	Soveltuu asennettavaksi normaalisti syttyville pinnoille	1
910925868381	SM350C 50S/840 PSU PCS L1500 BK	Soveltuu asennettavaksi normaalisti syttyville pinnoille	1

Order Code	Full Product Name	Syttövyysluokka	Välkyntäarvo (PstLM)
910925868384	SM350C 34S/840 PSD PCS L1500 BK	Soveltuu asennettavaksi normaalisti syttyville pinnoille	1
910925868387	SM350C 50S/840 PSD PCS L1500 BK	Soveltuu asennettavaksi normaalisti syttyville pinnoille	1
910925868303	SM350C 27S/840 PSU PCS L1200 ALU	Soveltuu asennettavaksi normaalisti syttyville pinnoille	1

KeyLine, pinta-asennettava ja ripustettava

Order Code	Full Product Name	Syttyvyysluokka	Välkyntäarvo (PstLM)
910925868353	SM350C 40S/840 PSU PCS L1200 ALU	Soveltuu asennettavaksi normaalisti syttyville pinnoille	1
910925868356	SM350C 27S/840 PSD PCS L1200 ALU	Soveltuu asennettavaksi normaalisti syttyville pinnoille	1
910925868359	SM350C 40S/840 PSD PCS L1200 ALU	Soveltuu asennettavaksi normaalisti syttyville pinnoille	1
910925868368	SM350C 27S/830 PSU PCS L1200 ALU	Soveltuu asennettavaksi normaalisti syttyville pinnoille	1
910925868370	SM350C 40S/830 PSU PCS L1200 ALU	Soveltuu asennettavaksi normaalisti syttyville pinnoille	1
910925868372	SM350C 27S/830 PSD PCS L1200 ALU	Soveltuu asennettavaksi normaalisti syttyville pinnoille	1
910925868374	SM350C 40S/830 PSD PCS L1200 ALU	Soveltuu asennettavaksi normaalisti syttyville pinnoille	1
910925868388	SM350X 27S/840 PSD L60L60 PCS ALU	Soveltuu asennettavaksi normaalisti syttyville pinnoille	1
910925868376	SM350C 34S/840 PSU PCS L1500 ALU	Soveltuu asennettavaksi normaalisti syttyville pinnoille	1
910925868379	SM350C 50S/840 PSU PCS L1500 ALU	Soveltuu asennettavaksi normaalisti syttyville pinnoille	1
910925868382	SM350C 34S/840 PSD PCS L1500 ALU	Soveltuu asennettavaksi normaalisti syttyville pinnoille	1
910925868385	SM350C 50S/840 PSD PCS L1500 ALU	Soveltuu asennettavaksi normaalisti syttyville pinnoille	1
910925868377	SM350C 34S/840 PSU PCS L1500 WH	Soveltuu asennettavaksi normaalisti syttyville pinnoille	1
910925868380	SM350C 50S/840 PSU PCS L1500 WH	Soveltuu asennettavaksi normaalisti syttyville pinnoille	1
910925868383	SM350C 34S/840 PSD PCS L1500 WH	Soveltuu asennettavaksi normaalisti syttyville pinnoille	1
910925868386	SM350C 50S/840 PSD PCS L1500 WH	Soveltuu asennettavaksi normaalisti syttyville pinnoille	1
910925868362	SM350C 27S/840 WIA PCS L1200 ALU	Soveltuu asennettavaksi normaalisti syttyville pinnoille	1

Order Code	Full Product Name	Syttyvyysluokka	Välkyntäarvo (PstLM)
910925868363	SM350C 27S/840 WIA PCS L1200 WH	Soveltuu asennettavaksi normaalisti syttyville pinnoille	1
910925868364	SM350C 27S/840 WIA PCS L1200 BK	Soveltuu asennettavaksi normaalisti syttyville pinnoille	1
910925868365	SM350C 40S/840 WIA PCS L1200 ALU	Soveltuu asennettavaksi normaalisti syttyville pinnoille	1
910925868366	SM350C 40S/840 WIA PCS L1200 WH	Soveltuu asennettavaksi normaalisti syttyville pinnoille	1
910925868367	SM350C 40S/840 WIA PCS L1200 BK	Soveltuu asennettavaksi normaalisti syttyville pinnoille	1
910925868351	SM350C 27S/840 PSU PCS L1200 WH	Soveltuu asennettavaksi normaalisti syttyville pinnoille	1
910925868354	SM350C 40S/840 PSU PCS L1200 WH	Soveltuu asennettavaksi normaalisti syttyville pinnoille	1
910925868357	SM350C 27S/840 PSD PCS L1200 WH	Soveltuu asennettavaksi normaalisti syttyville pinnoille	1
910925868360	SM350C 40S/840 PSD PCS L1200 WH	Soveltuu asennettavaksi normaalisti syttyville pinnoille	1
910925868369	SM350C 27S/830 PSU PCS L1200 WH	Soveltuu asennettavaksi normaalisti syttyville pinnoille	1
910925868371	SM350C 40S/830 PSU PCS L1200 WH	Soveltuu asennettavaksi normaalisti syttyville pinnoille	1
910925868373	SM350C 27S/830 PSD PCS L1200 WH	Soveltuu asennettavaksi normaalisti syttyville pinnoille	1
910925868375	SM350C 40S/830 PSD PCS L1200 WH	Soveltuu asennettavaksi normaalisti syttyville pinnoille	1
910925868352	SM350C 27S/840 PSU PCS L1200 BK	Soveltuu asennettavaksi normaalisti syttyville pinnoille	1
910925868355	SM350C 40S/840 PSU PCS L1200 BK	Soveltuu asennettavaksi normaalisti syttyville pinnoille	1
910925868358	SM350C 27S/840 PSD PCS L1200 BK	Soveltuu asennettavaksi normaalisti syttyville pinnoille	1
910925868361	SM350C 40S/840 PSD PCS L1200 BK	Soveltuu asennettavaksi normaalisti syttyville pinnoille	1

KeyLine, pinta-asennettava ja ripustettava

Order Code	Full Product Name	Sytyvyysluokka	Välkyntäarvo (PstLM)
910925868389	SM350X 27S/840 PSD L60L60 PCS WH	Soveltuu asennettavaksi normaalisti syttyville pinnoille	1
910505103701	SM351C 40S/840 PSU A PCS L1200 WH	-	-
910505103702	SM351C 40S/840 PSD A PCS L1200 WH	-	-

Order Code	Full Product Name	Sytyvyysluokka	Välkyntäarvo (PstLM)
910505103703	SM351C 50S/840 PSU A PCS L1500 WH	-	-
910505103704	SM351C 50S/840 PSD A PCS L1500 WH	-	-

Suorituskyky alussa (IEC-yhteensopiva)

Order Code	Full Product Name	Kromaattisuus alussa
910925868390	SM350X 27S/840 PSD PCS N BK	(0.39, 0.38) SDCM <3
910925868378	SM350C 34S/840 PSU PCS L1500 BK	(0.39, 0.38) SDCM <3
910925868381	SM350C 50S/840 PSU PCS L1500 BK	(0.39, 0.38) SDCM <3
910925868384	SM350C 34S/840 PSD PCS L1500 BK	(0.39, 0.38) SDCM <3
910925868387	SM350C 50S/840 PSD PCS L1500 BK	(0.39, 0.38) SDCM <3
910925868303	SM350C 27S/840 PSU PCS L1200 ALU	(0.39, 0.38) SDCM <3
910925868353	SM350C 40S/840 PSU PCS L1200 ALU	(0.39, 0.38) SDCM <3
910925868356	SM350C 27S/840 PSD PCS L1200 ALU	(0.39, 0.38) SDCM <3
910925868359	SM350C 40S/840 PSD PCS L1200 ALU	(0.39, 0.38) SDCM <3
910925868368	SM350C 27S/830 PSU PCS L1200 ALU	(0.43, 0.40) SDCM <3
910925868370	SM350C 40S/830 PSU PCS L1200 ALU	(0.43, 0.40) SDCM <3
910925868372	SM350C 27S/830 PSD PCS L1200 ALU	(0.43, 0.40) SDCM <3
910925868374	SM350C 40S/830 PSD PCS L1200 ALU	(0.43, 0.40) SDCM <3
910925868388	SM350X 27S/840 PSD L60L60 PCS ALU	(0.39, 0.38) SDCM <3
910925868376	SM350C 34S/840 PSU PCS L1500 ALU	(0.39, 0.38) SDCM <3
910925868379	SM350C 50S/840 PSU PCS L1500 ALU	(0.39, 0.38) SDCM <3
910925868382	SM350C 34S/840 PSD PCS L1500 ALU	(0.39, 0.38) SDCM <3
910925868385	SM350C 50S/840 PSD PCS L1500 ALU	(0.39, 0.38) SDCM <3
910925868377	SM350C 34S/840 PSU PCS L1500 WH	(0.39, 0.38) SDCM <3
910925868380	SM350C 50S/840 PSU PCS L1500 WH	(0.39, 0.38) SDCM <3
910925868383	SM350C 34S/840 PSD PCS L1500 WH	(0.39, 0.38) SDCM <3
910925868386	SM350C 50S/840 PSD PCS L1500 WH	(0.39, 0.38) SDCM <3
910925868362	SM350C 27S/840 WIA PCS L1200 ALU	(0.39, 0.38) SDCM <3

Order Code	Full Product Name	Kromaattisuus alussa
910925868363	SM350C 27S/840 WIA PCS L1200 WH	(0.39, 0.38) SDCM <3
910925868364	SM350C 27S/840 WIA PCS L1200 BK	(0.39, 0.38) SDCM <3
910925868365	SM350C 40S/840 WIA PCS L1200 ALU	(0.39, 0.38) SDCM <3
910925868366	SM350C 40S/840 WIA PCS L1200 WH	(0.39, 0.38) SDCM <3
910925868367	SM350C 40S/840 WIA PCS L1200 BK	(0.39, 0.38) SDCM <3
910925868351	SM350C 27S/840 PSU PCS L1200 WH	(0.39, 0.38) SDCM <3
910925868354	SM350C 40S/840 PSU PCS L1200 WH	(0.39, 0.38) SDCM <3
910925868357	SM350C 27S/840 PSD PCS L1200 WH	(0.39, 0.38) SDCM <3
910925868360	SM350C 40S/840 PSD PCS L1200 WH	(0.39, 0.38) SDCM <3
910925868369	SM350C 27S/830 PSU PCS L1200 WH	(0.43, 0.40) SDCM <3
910925868371	SM350C 40S/830 PSU PCS L1200 WH	(0.43, 0.40) SDCM <3
910925868373	SM350C 27S/830 PSD PCS L1200 WH	(0.43, 0.40) SDCM <3
910925868375	SM350C 40S/830 PSD PCS L1200 WH	(0.43, 0.40) SDCM <3
910925868352	SM350C 27S/840 PSU PCS L1200 BK	(0.39, 0.38) SDCM <3
910925868355	SM350C 40S/840 PSU PCS L1200 BK	(0.39, 0.38) SDCM <3
910925868358	SM350C 27S/840 PSD PCS L1200 BK	(0.39, 0.38) SDCM <3
910925868361	SM350C 40S/840 PSD PCS L1200 BK	(0.39, 0.38) SDCM <3
910925868389	SM350X 27S/840 PSD L60L60 PCS WH	(0.39, 0.38) SDCM <3
910505103701	SM351C 40S/840 PSU A PCS L1200 WH	(0.39, 0.38) SDCM <3
910505103702	SM351C 40S/840 PSD A PCS L1200 WH	(0.39, 0.38) SDCM <3
910505103703	SM351C 50S/840 PSU A PCS L1500 WH	(0.39, 0.38) SDCM <3
910505103704	SM351C 50S/840 PSD A PCS L1500 WH	(0.39, 0.38) SDCM <3

Tuotetiedot

Order Code	Full Product Name	Tuoteperheen koodi
910925868390	SM350X 27S/840 PSD PCS N BK	SM350X
910925868378	SM350C 34S/840 PSU PCS L1500 BK	SM350C
910925868381	SM350C 50S/840 PSU PCS L1500 BK	SM350C
910925868384	SM350C 34S/840 PSD PCS L1500 BK	SM350C
910925868387	SM350C 50S/840 PSD PCS L1500 BK	SM350C
910925868303	SM350C 27S/840 PSU PCS L1200 ALU	SM350C
910925868353	SM350C 40S/840 PSU PCS L1200 ALU	SM350C
910925868356	SM350C 27S/840 PSD PCS L1200 ALU	SM350C
910925868359	SM350C 40S/840 PSD PCS L1200 ALU	SM350C
910925868368	SM350C 27S/830 PSU PCS L1200 ALU	SM350C
910925868370	SM350C 40S/830 PSU PCS L1200 ALU	SM350C
910925868372	SM350C 27S/830 PSD PCS L1200 ALU	SM350C

Order Code	Full Product Name	Tuoteperheen koodi
910925868374	SM350C 40S/830 PSD PCS L1200 ALU	SM350C
910925868388	SM350X 27S/840 PSD L60L60 PCS ALU	SM350X
910925868376	SM350C 34S/840 PSU PCS L1500 ALU	SM350C
910925868379	SM350C 50S/840 PSU PCS L1500 ALU	SM350C
910925868382	SM350C 34S/840 PSD PCS L1500 ALU	SM350C
910925868385	SM350C 50S/840 PSD PCS L1500 ALU	SM350C
910925868377	SM350C 34S/840 PSU PCS L1500 WH	SM350C
910925868380	SM350C 50S/840 PSU PCS L1500 WH	SM350C
910925868383	SM350C 34S/840 PSD PCS L1500 WH	SM350C
910925868386	SM350C 50S/840 PSD PCS L1500 WH	SM350C
910925868362	SM350C 27S/840 WIA PCS L1200 ALU	SM350C
910925868363	SM350C 27S/840 WIA PCS L1200 WH	SM350C

KeyLine, pinta-asennettava ja ripustettava

Order Code	Full Product Name	Tuoteperheen koodi
910925868364	SM350C 27S/840 WIA PCS L1200 BK	SM350C
910925868365	SM350C 40S/840 WIA PCS L1200 ALU	SM350C
910925868366	SM350C 40S/840 WIA PCS L1200 WH	SM350C
910925868367	SM350C 40S/840 WIA PCS L1200 BK	SM350C
910925868351	SM350C 27S/840 PSU PCS L1200 WH	SM350C
910925868354	SM350C 40S/840 PSU PCS L1200 WH	SM350C
910925868357	SM350C 27S/840 PSD PCS L1200 WH	SM350C
910925868360	SM350C 40S/840 PSD PCS L1200 WH	SM350C
910925868369	SM350C 27S/830 PSU PCS L1200 WH	SM350C
910925868371	SM350C 40S/830 PSU PCS L1200 WH	SM350C
910925868373	SM350C 27S/830 PSD PCS L1200 WH	SM350C

Order Code	Full Product Name	Tuoteperheen koodi
910925868375	SM350C 40S/830 PSD PCS L1200 WH	SM350C
910925868352	SM350C 27S/840 PSU PCS L1200 BK	SM350C
910925868355	SM350C 40S/840 PSU PCS L1200 BK	SM350C
910925868358	SM350C 27S/840 PSD PCS L1200 BK	SM350C
910925868361	SM350C 40S/840 PSD PCS L1200 BK	SM350C
910925868389	SM350X 27S/840 PSD L60L60 PCS WH	SM350X
910505103701	SM351C 40S/840 PSU A PCS L1200 WH	SM350C
910505103702	SM351C 40S/840 PSD A PCS L1200 WH	SM350C
910505103703	SM351C 50S/840 PSU A PCS L1500 WH	SM350C
910505103704	SM351C 50S/840 PSD A PCS L1500 WH	SM350C

Polar Wide Diagrams

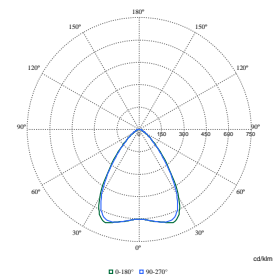
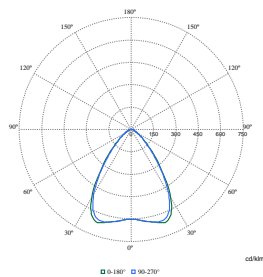
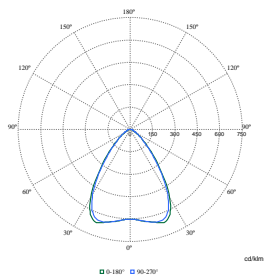

Polar Normal (separate) - SM350CI - 910925868303

Polar Normal (separate) - SM350CI - 910925868353

Polar Normal (separate) - SM350CI - 910925868366

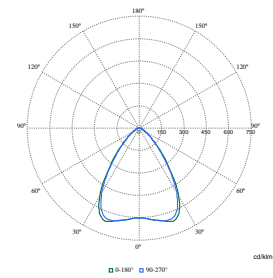
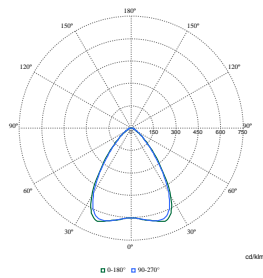
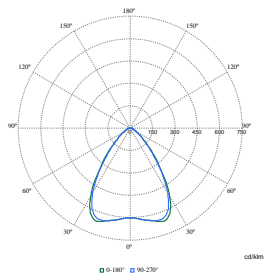

Polar Normal (separate) - SM350CI - 910925868379

Polar Normal (separate) - SM350CI - 910925868355

Polar Normal (separate) - SM350CI - 910925868356

KeyLine, pinta-asennettava ja ripustettava

Polar Wide Diagrams

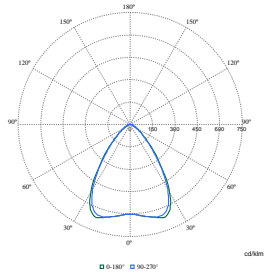

Polar Normal (separate) - SM350CI - 910925868383

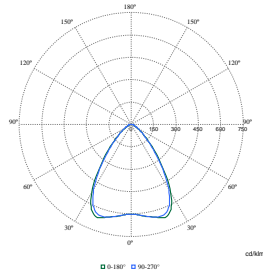

Polar Normal (separate) - SM350CI - 910925868352

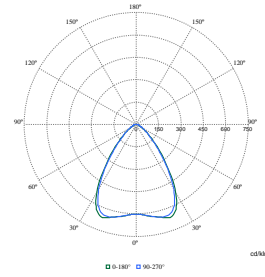

Polar Normal (separate) - SM350CI - 910925868359

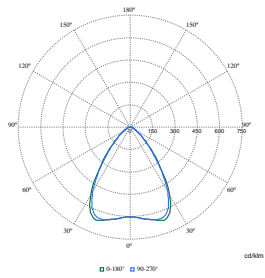

Polar Normal (separate) - SM350CI - 910925868363

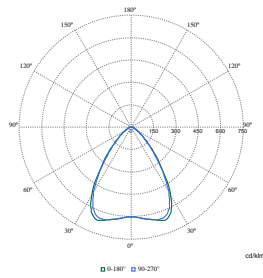

Polar Normal (separate) - SM350CI - 910925868375

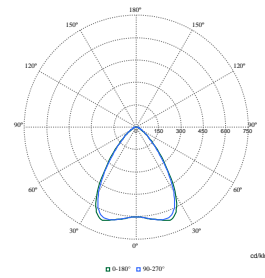

Polar Normal (separate) - SM350CI - 910925868381

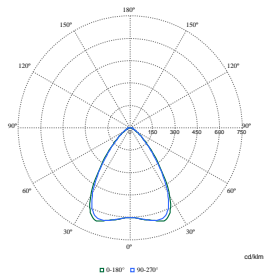

Polar Normal (separate) - SM350CI - 910925868385

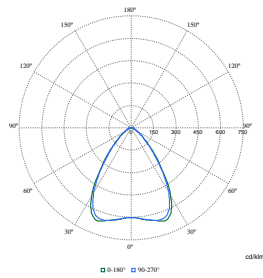

Polar Normal (separate) - SM350CI - 910925868388

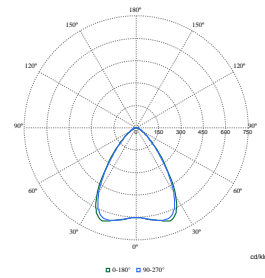

Polar Normal (separate) - SM350CI - 910925868389

KeyLine, pinta-asennettava ja ripustettava

Polar Wide Diagrams

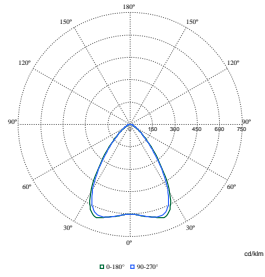

Polar Normal (separate) - SM350CI - 910925868354

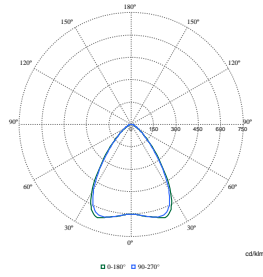

Polar Normal (separate) - SM350CI - 910925868387

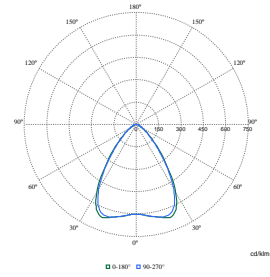

Polar Normal (separate) - SM350CI - 910925868362

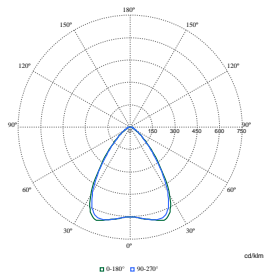

Polar Normal (separate) - SM350CI - 910925868365

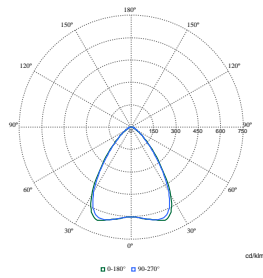

Polar Normal (separate) - SM350CI - 910925868370

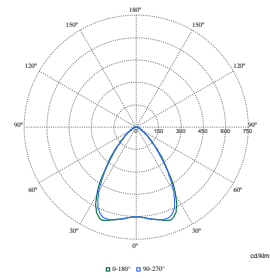

Polar Normal (separate) - SM350CI - 910925868384

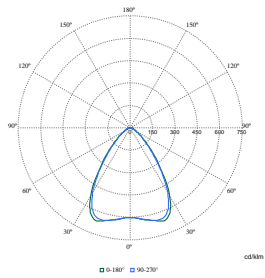

Polar Normal (separate) - SM350CI - 910925868386

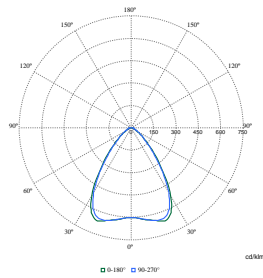

Polar Normal (separate) - SM350CI - 910925868360

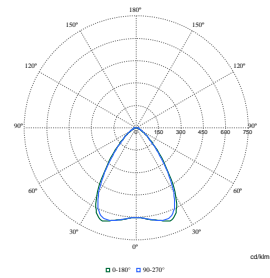

Polar Normal (separate) - SM350CI - 910925868361

KeyLine, pinta-asennettava ja ripustettava

Polar Wide Diagrams

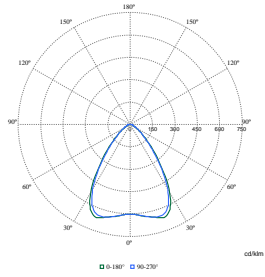

Polar Normal (separate) - SM350CI - 910925868367

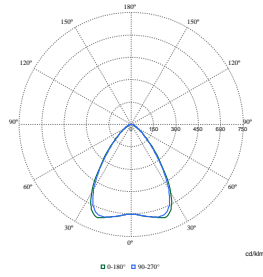

Polar Normal (separate) - SM350CI - 910925868357

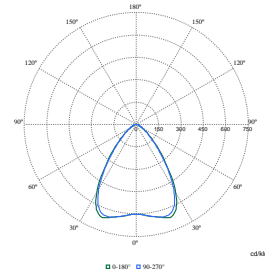

Polar Normal (separate) - SM350CI - 910925868368

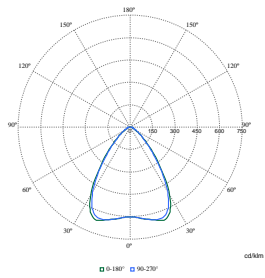

Polar Normal (separate) - SM350CI - 910925868358

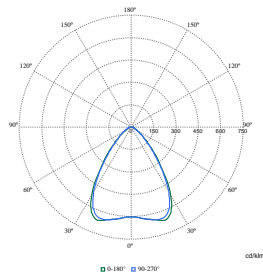

Polar Normal (separate) - SM350CI - 910925868364

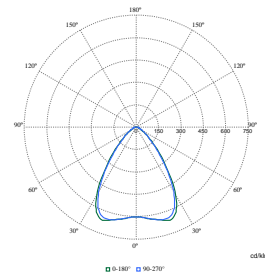

Polar Normal (separate) - SM350CI - 910925868372

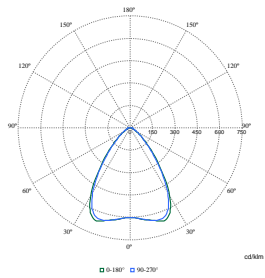

Polar Normal (separate) - SM350CI - 910925868376

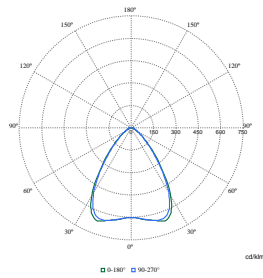

Polar Normal (separate) - SM350CI - 910925868378

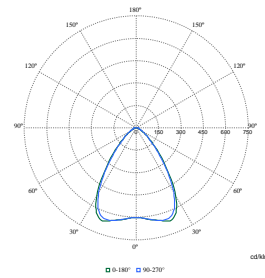

Polar Normal (separate) - SM350CI - 910925868380

KeyLine, pinta-asennettava ja ripustettava

Polar Wide Diagrams

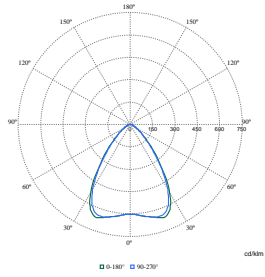

Polar Normal (separate) - SM350CI - 910925868351

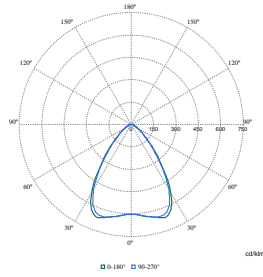

Polar Normal (separate) - SM350CI - 910925868369

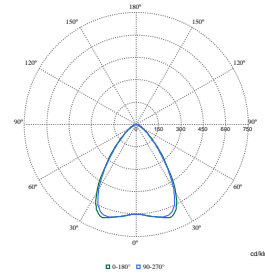

Polar Normal (separate) - SM350CI - 910925868371

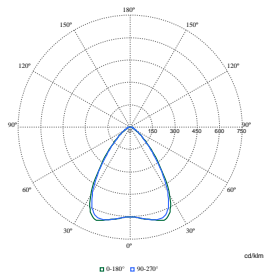

Polar Normal (separate) - SM350CI - 910925868374

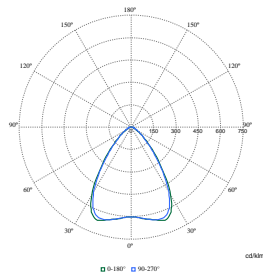

Polar Normal (separate) - SM350CI - 910925868373

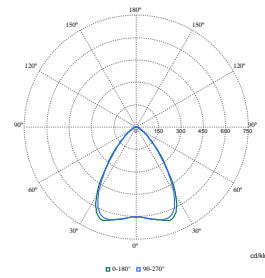

Polar Normal (separate) - SM350CI - 910925868377

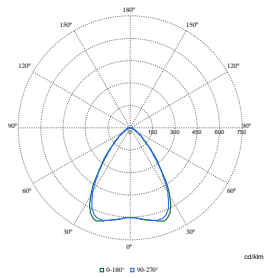

Polar Normal (separate) - SM350CI - 910925868382

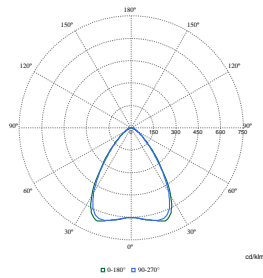

Polar Normal (separate) - SM350CI - 910925868390

KeyLine, pinta-asennettava ja ripustettava

