



The flexible light line

KeyLine, Surface & Suspended

These days, many office owners and office lighting designers prefer lines of light. The reason is simple. Not only do light lines come in a minimalistic design; they also offer far more choice and flexibility. Short or long lines and luminaires, standalone luminaires, different optics including asymmetric, different shapes and even a variety of colors; anything is possible. And with KeyLine, all these benefits come at a competitive price while still complying with office lighting norms. KeyLine is a superb light line range with a slim, minimalistic design and a high lumen output to illuminate the brightest office spaces. But with comfortable, low levels of glare it's also easy on the eye and complies with UGR19. That makes KeyLine ideal for linear applications, as well as standalone suspended or surface-mounted luminaires (Accessories to be ordered separately). A range that offers the ultimate flexibility and unlimited possibilities. KeyLine design flexibility comes in the form of different lengths, colors and light outputs - including L-shapes, as well as straight lines. All with high efficiency up to 142 lm/W, and the option to upgrade with wireless connectivity and control. Add to that attractive pricing, and with KeyLine you can also enjoy excellent value that ensures a superb total cost of ownership.

Benefits

- Suitable for office applications
- Excellent total cost of ownership
- Wide range of options to suit the demands of different offices

Features

- Comfortable, low glare: <UGR19 for the full range
- High lumen output, up to 4000lm for 1.2m version
- Interact Connectivity ready with wireless drivers
- Standard options in different lengths, colors and light outputs
- Customization options

KeyLine, Surface & Suspended

Application

- Offices
- Retail
- Education

Warnings and Safety

- KeyLine luminaires have an IP20 classification and are not protected against water ingress. We strongly recommend that the installation environment is checked for suitability.
- If – despite the IPX0 classification warning – luminaires are subject to water ingress, Philips and Signify cannot guarantee safety or prevent failure. In this case the product warranty does not apply and becomes void.

Versions



KeyLine L-corner, black

KeyLine L-corner, alu

KeyLine suspended L1200, bk

KeyLine L-corner, white



KeyLine Asymmetric SM531C SPP

Dimensional drawing

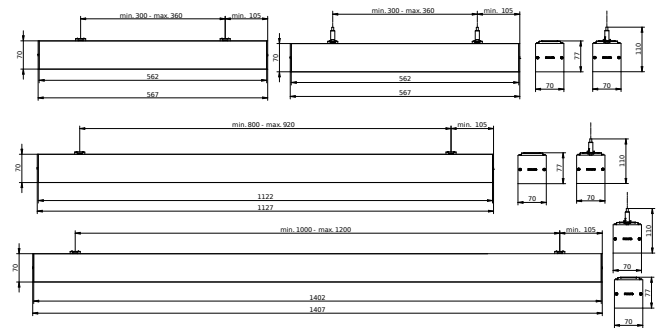
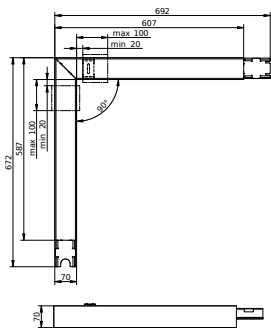

KeyLine, Surface & Suspended

Dimensional drawing

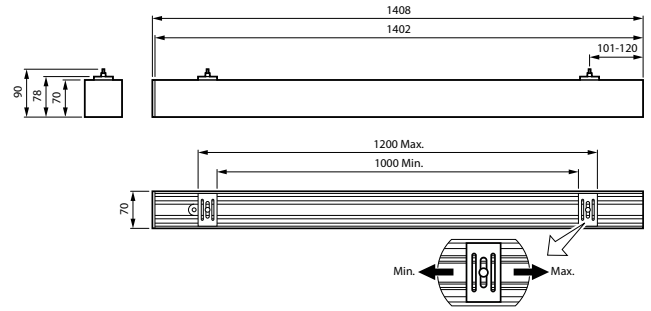
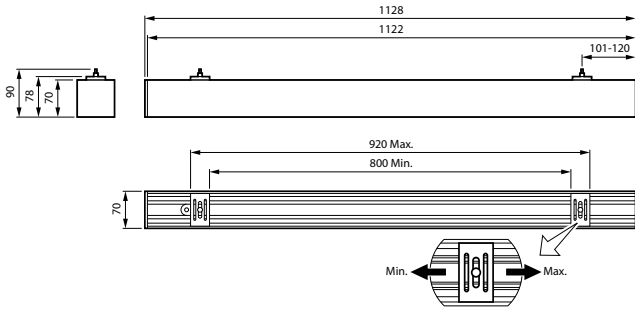

Product details



KeyLine line coupling, alu



KeyLine black with ceiling bracket accessory for surface mounting

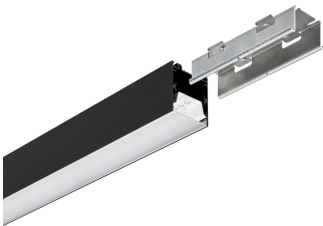

KeyLine black with coupling piece accessory for line mounting



KeyLine Asymmetric SM531C detailed



KeyLine_SM350C_WIA_DPPI



KeyLine line configuration, white



KeyLine SM350C, white



KeyLine configuration with L-corner SM350X

KeyLine, Surface & Suspended

Product details

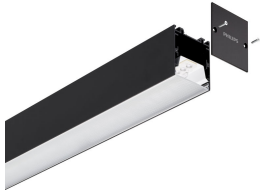

KeyLine black with end-cap accessory



KeyLine line coupling, white



KeyLine alu with suspension set for suspended mounting

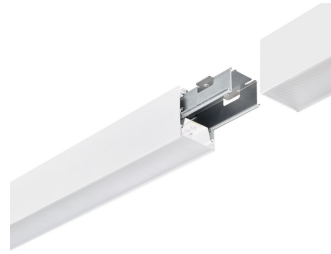

KeyLine white line coupling with coupling piece accessory



KeyLine_SM350C_WIA_DPP3



KeyLine alu with end-cap accessory



KeyLine white with coupling piece accessory for line mounting



KeyLine structured optics UGR19 (PCS)



KeyLine line coupling, black

KeyLine, Surface & Suspended

Product details

KeyLine SM350C, alu



KeyLine alu line coupling with coupling piece accessory

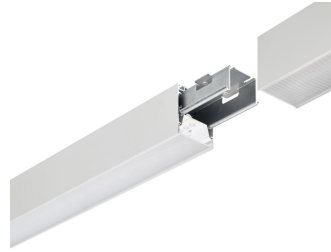

KeyLine line configuration, black



KeyLine alu with ceiling bracket accessory for surface mounting



KeyLine white with suspension set for suspended mounting



KeyLine white with ceiling bracket accessory for surface mounting



KeyLine white with end-cap accessory



KeyLine alu with coupling piece accessory for line mounting

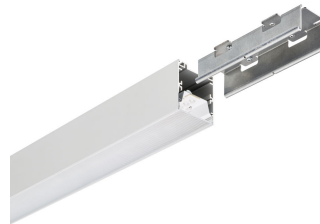

KeyLine SM350C, black



KeyLine L-corner, black

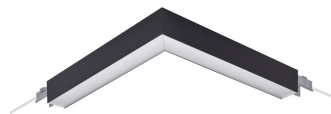

KeyLine, Surface & Suspended

Product details

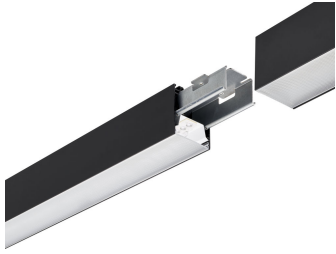

KeyLine black line coupling with coupling piece accessory



KeyLine black with suspension set for suspended mounting



KeyLine_SM350C_WIA_DPP2



KeyLine L-corner, alu



KeyLine L-corner, white

KeyLine, Surface & Suspended

General Information	
Driver included	Yes
Number of gear units	1 unit
Service tag	Yes
Light Technical	
Color rendering index (CRI)	>80
Operating and Electrical	
Protection class IEC	Safety class I
Line Frequency	50 to 60 Hz
Mechanical and Housing	
Mech. impact protection code	IK06
Ingress protection code	IP20
Approval and Application	
Ambient temperature range	+10 to +35 °C
CE mark	Yes
ENEC mark	ENEC mark
Glow-wire test	Temperature 650 °C, duration 30 s
Stroboscopic effect visibility measure (SVM)	0.4
Initial Performance (IEC Compliant)	
Luminous flux tolerance	+/-10%

General Information

Order Code	Full Product Name	Light source replaceable
62454200	SM350X 27S/840 PSD PCS N BK	No
62442900	SM350C 34S/840 PSU PCS L1500 BK	No
62445000	SM350C 50S/840 PSU PCS L1500 BK	No
62448100	SM350C 34S/840 PSD PCS L1500 BK	No
62451100	SM350C 50S/840 PSD PCS L1500 BK	No
62367500	SM350C 27S/840 PSU PCS L1200 ALU	No
62417700	SM350C 40S/840 PSU PCS L1200 ALU	No
62420700	SM350C 27S/840 PSD PCS L1200 ALU	No
62423800	SM350C 40S/840 PSD PCS L1200 ALU	No
62432000	SM350C 27S/830 PSU PCS L1200 ALU	No
62434400	SM350C 40S/830 PSU PCS L1200 ALU	No
62436800	SM350C 27S/830 PSD PCS L1200 ALU	No
62438200	SM350C 40S/830 PSD PCS L1200 ALU	No
62452800	SM350X 27S/840 PSD L60L60 PCS ALU	No
62440500	SM350C 34S/840 PSU PCS L1500 ALU	No
62443600	SM350C 50S/840 PSU PCS L1500 ALU	No
62446700	SM350C 34S/840 PSD PCS L1500 ALU	No
62449800	SM350C 50S/840 PSD PCS L1500 ALU	No
62441200	SM350C 34S/840 PSU PCS L1500 WH	No
62444300	SM350C 50S/840 PSU PCS L1500 WH	No
62447400	SM350C 34S/840 PSD PCS L1500 WH	No
62450400	SM350C 50S/840 PSD PCS L1500 WH	No
62430600	SM350C 40S/840 WIA PCS L1200 WH	No
62431300	SM350C 40S/840 WIA PCS L1200 BK	No
62415300	SM350C 27S/840 PSU PCS L1200 WH	No
62418400	SM350C 40S/840 PSU PCS L1200 WH	No
62421400	SM350C 27S/840 PSD PCS L1200 WH	No
62424500	SM350C 40S/840 PSD PCS L1200 WH	No
62433700	SM350C 27S/830 PSU PCS L1200 WH	No
62435100	SM350C 40S/830 PSU PCS L1200 WH	No
62437500	SM350C 27S/830 PSD PCS L1200 WH	No
62439900	SM350C 40S/830 PSD PCS L1200 WH	No
62416000	SM350C 27S/840 PSU PCS L1200 BK	No
62419100	SM350C 40S/840 PSU PCS L1200 BK	No
62422100	SM350C 27S/840 PSD PCS L1200 BK	No
62425200	SM350C 40S/840 PSD PCS L1200 BK	No
62453500	SM350X 27S/840 PSD L60L60 PCS WH	No
61518200	SM351C 40S/840 PSU A PCS L1200 WH	-
61519900	SM351C 40S/840 PSD A PCS L1200 WH	-
61520500	SM351C 50S/840 PSU A PCS L1500 WH	-
61521200	SM351C 50S/840 PSD A PCS L1500 WH	-

Light Technical (1/2)

KeyLine, Surface & Suspended

Order Code	Full Product Name	Beam angle of light source	Correlated Color Temperature (Nom)	Luminous Efficacy (rated) (Nom)	Luminous Flux
62454200	SM350X 27S/840 PSD PCS N BK	120 degree(s)	4000 K	135 lm/W	2,700 lm
62442900	SM350C 34S/840 PSU PCS L1500 BK	120 degree(s)	4000 K	142 lm/W	3,400 lm
62445000	SM350C 50S/840 PSU PCS L1500 BK	120 degree(s)	4000 K	135 lm/W	5,000 lm
62448100	SM350C 34S/840 PSD PCS L1500 BK	120 degree(s)	4000 K	136 lm/W	3,400 lm
62451100	SM350C 50S/840 PSD PCS L1500 BK	120 degree(s)	4000 K	135 lm/W	5,000 lm
62367500	SM350C 27S/840 PSU PCS L1200 ALU	120 degree(s)	4000 K	138 lm/W	2,700 lm
62417700	SM350C 40S/840 PSU PCS L1200 ALU	120 degree(s)	4000 K	133 lm/W	4,000 lm
62420700	SM350C 27S/840 PSD PCS L1200 ALU	120 degree(s)	4000 K	135 lm/W	2,700 lm
62423800	SM350C 40S/840 PSD PCS L1200 ALU	120 degree(s)	4000 K	133 lm/W	4,000 lm
62432000	SM350C 27S/830 PSU PCS L1200 ALU	120 degree(s)	3000 K	132 lm/W	2,700 lm
62434400	SM350C 40S/830 PSU PCS L1200 ALU	120 degree(s)	3000 K	133 lm/W	4,000 lm
62436800	SM350C 27S/830 PSD PCS L1200 ALU	120 degree(s)	3000 K	135 lm/W	2,700 lm
62438200	SM350C 40S/830 PSD PCS L1200 ALU	120 degree(s)	3000 K	129 lm/W	4,000 lm
62452800	SM350X 27S/840 PSD L60L60 PCS ALU	120 degree(s)	4000 K	135 lm/W	2,700 lm
62440500	SM350C 34S/840 PSU PCS L1500 ALU	120 degree(s)	4000 K	142 lm/W	3,400 lm
62443600	SM350C 50S/840 PSU PCS L1500 ALU	120 degree(s)	4000 K	135 lm/W	5,000 lm

Order Code	Full Product Name	Beam angle of light source	Correlated Color Temperature (Nom)	Luminous Efficacy (rated) (Nom)	Luminous Flux
62446700	SM350C 34S/840 PSD PCS L1500 ALU	120 degree(s)	4000 K	136 lm/W	3,400 lm
62449800	SM350C 50S/840 PSD PCS L1500 ALU	120 degree(s)	4000 K	135 lm/W	5,000 lm
62441200	SM350C 34S/840 PSU PCS L1500 WH	120 degree(s)	4000 K	142 lm/W	3,400 lm
62444300	SM350C 50S/840 PSU PCS L1500 WH	120 degree(s)	4000 K	135 lm/W	5,000 lm
62447400	SM350C 34S/840 PSD PCS L1500 WH	120 degree(s)	4000 K	136 lm/W	3,400 lm
62450400	SM350C 50S/840 PSD PCS L1500 WH	120 degree(s)	4000 K	135 lm/W	5,000 lm
62430600	SM350C 40S/840 WIA PCS L1200 WH	120 degree(s)	4000 K	133 lm/W	4,000 lm
62431300	SM350C 40S/840 WIA PCS L1200 BK	120 degree(s)	4000 K	133 lm/W	4,000 lm
62415300	SM350C 27S/840 PSU PCS L1200 WH	120 degree(s)	4000 K	138 lm/W	2,700 lm
62418400	SM350C 40S/840 PSU PCS L1200 WH	120 degree(s)	4000 K	133 lm/W	4,000 lm
62421400	SM350C 27S/840 PSD PCS L1200 WH	120 degree(s)	4000 K	135 lm/W	2,700 lm
62424500	SM350C 40S/840 PSD PCS L1200 WH	120 degree(s)	4000 K	133 lm/W	4,000 lm
62433700	SM350C 27S/830 PSU PCS L1200 WH	120 degree(s)	3000 K	132 lm/W	2,700 lm
62435100	SM350C 40S/830 PSU PCS L1200 WH	120 degree(s)	3000 K	133 lm/W	4,000 lm
62437500	SM350C 27S/830 PSD PCS L1200 WH	120 degree(s)	3000 K	135 lm/W	2,700 lm
62439900	SM350C 40S/830 PSD PCS L1200 WH	120 degree(s)	3000 K	129 lm/W	4,000 lm

KeyLine, Surface & Suspended

Order Code	Full Product Name	Beam angle of light source	Correlated Color Temperature (Nom)	Luminous Efficacy (rated) (Nom)	Luminous Flux
62416000	SM350C 27S/840 PSU PCS L1200 BK	120 degree(s)	4000 K	138 lm/W	2,700 lm
62419100	SM350C 40S/840 PSU PCS L1200 BK	120 degree(s)	4000 K	133 lm/W	4,000 lm
62422100	SM350C 27S/840 PSD PCS L1200 BK	120 degree(s)	4000 K	135 lm/W	2,700 lm
62425200	SM350C 40S/840 PSD PCS L1200 BK	120 degree(s)	4000 K	133 lm/W	4,000 lm
62453500	SM350X 27S/840 PSD	120 degree(s)	4000 K	135 lm/W	2,700 lm

Order Code	Full Product Name	Beam angle of light source	Correlated Color Temperature (Nom)	Luminous Efficacy (rated) (Nom)	Luminous Flux
	L60L60 PCS WH				
61518200	SM351C 40S/840 PSU A PCS L1200 WH	-	4000 K	133 lm/W	4,000 lm
61519900	SM351C 40S/840 PSD A PCS L1200 WH	-	4000 K	133 lm/W	4,000 lm
61520500	SM351C 50S/840 PSU A PCS L1500 WH	-	4000 K	135 lm/W	5,000 lm
61521200	SM351C 50S/840 PSD A PCS L1500 WH	-	4000 K	132 lm/W	5,000 lm

Light Technical (2/2)

Order Code	Full Product Name	Optic type
62454200	SM350X 27S/840 PSD PCS N BK	Medium beam
62442900	SM350C 34S/840 PSU PCS L1500 BK	Medium beam
62445000	SM350C 50S/840 PSU PCS L1500 BK	Medium beam
62448100	SM350C 34S/840 PSD PCS L1500 BK	Medium beam
62451100	SM350C 50S/840 PSD PCS L1500 BK	Medium beam
62367500	SM350C 27S/840 PSU PCS L1200 ALU	Medium beam
62417700	SM350C 40S/840 PSU PCS L1200 ALU	Medium beam
62420700	SM350C 27S/840 PSD PCS L1200 ALU	Medium beam
62423800	SM350C 40S/840 PSD PCS L1200 ALU	Medium beam
62432000	SM350C 27S/830 PSU PCS L1200 ALU	Medium beam
62434400	SM350C 40S/830 PSU PCS L1200 ALU	Medium beam
62436800	SM350C 27S/830 PSD PCS L1200 ALU	Medium beam
62438200	SM350C 40S/830 PSD PCS L1200 ALU	Medium beam
62452800	SM350X 27S/840 PSD L60L60 PCS ALU	Medium beam
62440500	SM350C 34S/840 PSU PCS L1500 ALU	Medium beam
62443600	SM350C 50S/840 PSU PCS L1500 ALU	Medium beam
62446700	SM350C 34S/840 PSD PCS L1500 ALU	Medium beam
62449800	SM350C 50S/840 PSD PCS L1500 ALU	Medium beam
62441200	SM350C 34S/840 PSU PCS L1500 WH	Medium beam
62444300	SM350C 50S/840 PSU PCS L1500 WH	Medium beam
62447400	SM350C 34S/840 PSD PCS L1500 WH	Medium beam

Order Code	Full Product Name	Optic type
62450400	SM350C 50S/840 PSD PCS L1500 WH	Medium beam
62430600	SM350C 40S/840 WIA PCS L1200 WH	Medium beam
62431300	SM350C 40S/840 WIA PCS L1200 BK	Medium beam
62415300	SM350C 27S/840 PSU PCS L1200 WH	Medium beam
62418400	SM350C 40S/840 PSU PCS L1200 WH	Medium beam
62421400	SM350C 27S/840 PSD PCS L1200 WH	Medium beam
62424500	SM350C 40S/840 PSD PCS L1200 WH	Medium beam
62433700	SM350C 27S/830 PSU PCS L1200 WH	Medium beam
62435100	SM350C 40S/830 PSU PCS L1200 WH	Medium beam
62437500	SM350C 27S/830 PSD PCS L1200 WH	Medium beam
62439900	SM350C 40S/830 PSD PCS L1200 WH	Medium beam
62416000	SM350C 27S/840 PSU PCS L1200 BK	Medium beam
62419100	SM350C 40S/840 PSU PCS L1200 BK	Medium beam
62422100	SM350C 27S/840 PSD PCS L1200 BK	Medium beam
62425200	SM350C 40S/840 PSD PCS L1200 BK	Medium beam
62453500	SM350X 27S/840 PSD L60L60 PCS WH	Medium beam
61518200	SM351C 40S/840 PSU A PCS L1200 WH	Assymetric Beam angle
61519900	SM351C 40S/840 PSD A PCS L1200 WH	Assymetric Beam angle
61520500	SM351C 50S/840 PSU A PCS L1500 WH	Assymetric Beam angle
61521200	SM351C 50S/840 PSD A PCS L1500 WH	Assymetric Beam angle

Operating and Electrical

Order Code	Full Product Name	Input Voltage	Power Consumption	Suitable for
				random switching
62454200	SM350X 27S/840 PSD PCS N BK	220 to 240 V	21 W	No

Order Code	Full Product Name	Input Voltage	Power Consumption	Suitable for
				random switching
62442900	SM350C 34S/840 PSU PCS L1500 BK	220 to 240 V	25 W	No

KeyLine, Surface & Suspended

Order Code	Full Product Name	Input Voltage	Power	Suitable for random switching
			Consumption	
62445000	SM350C 50S/840 PSU PCS L1500 BK	220 to 240 V	36.5 W	No
62448100	SM350C 34S/840 PSD PCS L1500 BK	220 to 240 V	26 W	No
62451100	SM350C 50S/840 PSD PCS L1500 BK	220 to 240 V	38 W	No
62367500	SM350C 27S/840 PSU PCS L1200 ALU	220 to 240 V	20.5 W	No
62417700	SM350C 40S/840 PSU PCS L1200 ALU	220 to 240 V	30 W	No
62420700	SM350C 27S/840 PSD PCS L1200 ALU	220 to 240 V	21 W	No
62423800	SM350C 40S/840 PSD PCS L1200 ALU	220 to 240 V	31 W	No
62432000	SM350C 27S/830 PSU PCS L1200 ALU	220 to 240 V	20.5 W	No
62434400	SM350C 40S/830 PSU PCS L1200 ALU	220 to 240 V	30 W	No
62436800	SM350C 27S/830 PSD PCS L1200 ALU	220 to 240 V	21 W	No
62438200	SM350C 40S/830 PSD PCS L1200 ALU	220 to 240 V	31 W	No
62452800	SM350X 27S/840 PSD L60L60 PCS ALU	220 to 240 V	21 W	No
62440500	SM350C 34S/840 PSU PCS L1500 ALU	220 to 240 V	25 W	No
62443600	SM350C 50S/840 PSU PCS L1500 ALU	220 to 240 V	36.5 W	No
62446700	SM350C 34S/840 PSD PCS L1500 ALU	220 to 240 V	26 W	No
62449800	SM350C 50S/840 PSD PCS L1500 ALU	220 to 240 V	38 W	No
62441200	SM350C 34S/840 PSU PCS L1500 WH	220 to 240 V	25 W	No
62444300	SM350C 50S/840 PSU PCS L1500 WH	220 to 240 V	36.5 W	No
62447400	SM350C 34S/840 PSD PCS L1500 WH	220 to 240 V	26 W	No
62450400	SM350C 50S/840 PSD PCS L1500 WH	220 to 240 V	38 W	No

Order Code	Full Product Name	Input Voltage	Power	Suitable for random switching
			Consumption	
62430600	SM350C 40S/840 WIA PCS L1200 WH	220 to 240 V	30 W	No
62431300	SM350C 40S/840 WIA PCS L1200 BK	220 to 240 V	30 W	No
62415300	SM350C 27S/840 PSU PCS L1200 WH	220 to 240 V	20.5 W	No
62418400	SM350C 40S/840 PSU PCS L1200 WH	220 to 240 V	30 W	No
62421400	SM350C 27S/840 PSD PCS L1200 WH	220 to 240 V	21 W	No
62424500	SM350C 40S/840 PSD PCS L1200 WH	220 to 240 V	31 W	No
62433700	SM350C 27S/830 PSU PCS L1200 WH	220 to 240 V	20.5 W	No
62435100	SM350C 40S/830 PSU PCS L1200 WH	220 to 240 V	30 W	No
62437500	SM350C 27S/830 PSD PCS L1200 WH	220 to 240 V	21 W	No
62439900	SM350C 40S/830 PSD PCS L1200 WH	220 to 240 V	31 W	No
62416000	SM350C 27S/840 PSU PCS L1200 BK	220 to 240 V	20.5 W	No
62419100	SM350C 40S/840 PSU PCS L1200 BK	220 to 240 V	30 W	No
62422100	SM350C 27S/840 PSD PCS L1200 BK	220 to 240 V	21 W	No
62425200	SM350C 40S/840 PSD PCS L1200 BK	220 to 240 V	31 W	No
62453500	SM350X 27S/840 PSD L60L60 PCS WH	220 to 240 V	21 W	No
61518200	SM351C 40S/840 PSU A PCS L1200 WH	220-240 V	30 W	Not applicable
61519900	SM351C 40S/840 PSD A PCS L1200 WH	220-240 V	31 W	Not applicable
61520500	SM351C 50S/840 PSU A PCS L1500 WH	220-240 V	37 W	Not applicable
61521200	SM351C 50S/840 PSD A PCS L1500 WH	220-240 V	38 W	Not applicable

Controls and Dimming

Order Code	Full Product Name	Dimmable	Maximum dim level
62454200	SM350X 27S/840 PSD PCS N BK	Yes	1%
62442900	SM350C 34S/840 PSU PCS L1500 BK	No	Not applicable
62445000	SM350C 50S/840 PSU PCS L1500 BK	No	Not applicable
62448100	SM350C 34S/840 PSD PCS L1500 BK	Yes	1%
62451100	SM350C 50S/840 PSD PCS L1500 BK	Yes	1%
62367500	SM350C 27S/840 PSU PCS L1200 ALU	No	Not applicable

Order Code	Full Product Name	Dimmable	Maximum dim level
62417700	SM350C 40S/840 PSU PCS L1200 ALU	No	Not applicable
62420700	SM350C 27S/840 PSD PCS L1200 ALU	Yes	1%
62423800	SM350C 40S/840 PSD PCS L1200 ALU	Yes	1%
62432000	SM350C 27S/830 PSU PCS L1200 ALU	No	Not applicable
62434400	SM350C 40S/830 PSU PCS L1200 ALU	No	Not applicable
62436800	SM350C 27S/830 PSD PCS L1200 ALU	Yes	1%

KeyLine, Surface & Suspended

Order Code	Full Product Name	Dimmable	Maximum dim level
62438200	SM350C 40S/830 PSD PCS L1200 ALU	Yes	1%
62452800	SM350X 27S/840 PSD L60L60 PCS ALU	Yes	1%
62440500	SM350C 34S/840 PSU PCS L1500 ALU	No	Not applicable
62443600	SM350C 50S/840 PSU PCS L1500 ALU	No	Not applicable
62446700	SM350C 34S/840 PSD PCS L1500 ALU	Yes	1%
62449800	SM350C 50S/840 PSD PCS L1500 ALU	Yes	1%
62441200	SM350C 34S/840 PSU PCS L1500 WH	No	Not applicable
62444300	SM350C 50S/840 PSU PCS L1500 WH	No	Not applicable
62447400	SM350C 34S/840 PSD PCS L1500 WH	Yes	1%
62450400	SM350C 50S/840 PSD PCS L1500 WH	Yes	1%
62430600	SM350C 40S/840 WIA PCS L1200 WH	No	1%
62431300	SM350C 40S/840 WIA PCS L1200 BK	No	1%
62415300	SM350C 27S/840 PSU PCS L1200 WH	No	Not applicable
62418400	SM350C 40S/840 PSU PCS L1200 WH	No	Not applicable
62421400	SM350C 27S/840 PSD PCS L1200 WH	Yes	1%

Order Code	Full Product Name	Dimmable	Maximum dim level
62424500	SM350C 40S/840 PSD PCS L1200 WH	Yes	1%
62433700	SM350C 27S/830 PSU PCS L1200 WH	No	Not applicable
62435100	SM350C 40S/830 PSU PCS L1200 WH	No	Not applicable
62437500	SM350C 27S/830 PSD PCS L1200 WH	Yes	1%
62439900	SM350C 40S/830 PSD PCS L1200 WH	Yes	1%
62416000	SM350C 27S/840 PSU PCS L1200 BK	No	Not applicable
62419100	SM350C 40S/840 PSU PCS L1200 BK	No	Not applicable
62422100	SM350C 27S/840 PSD PCS L1200 BK	Yes	1%
62425200	SM350C 40S/840 PSD PCS L1200 BK	Yes	1%
62453500	SM350X 27S/840 PSD L60L60 PCS WH	Yes	1%
61518200	SM351C 40S/840 PSU A PCS L1200 WH	No	Not applicable
61519900	SM351C 40S/840 PSD A PCS L1200 WH	-	1%
61520500	SM351C 50S/840 PSU A PCS L1500 WH	No	Not applicable
61521200	SM351C 50S/840 PSD A PCS L1500 WH	-	1%

Mechanical and Housing

Order Code	Full Product Name	Housing Color
62454200	SM350X 27S/840 PSD PCS N BK	Black
62442900	SM350C 34S/840 PSU PCS L1500 BK	Black
62445000	SM350C 50S/840 PSU PCS L1500 BK	Black
62448100	SM350C 34S/840 PSD PCS L1500 BK	Black
62451100	SM350C 50S/840 PSD PCS L1500 BK	Black
62367500	SM350C 27S/840 PSU PCS L1200 ALU	Aluminum
62417700	SM350C 40S/840 PSU PCS L1200 ALU	Aluminum
62420700	SM350C 27S/840 PSD PCS L1200 ALU	Aluminum
62423800	SM350C 40S/840 PSD PCS L1200 ALU	Aluminum
62432000	SM350C 27S/830 PSU PCS L1200 ALU	Aluminum
62434400	SM350C 40S/830 PSU PCS L1200 ALU	Aluminum
62436800	SM350C 27S/830 PSD PCS L1200 ALU	Aluminum
62438200	SM350C 40S/830 PSD PCS L1200 ALU	Aluminum
62452800	SM350X 27S/840 PSD L60L60 PCS ALU	Aluminum
62440500	SM350C 34S/840 PSU PCS L1500 ALU	Aluminum
62443600	SM350C 50S/840 PSU PCS L1500 ALU	Aluminum
62446700	SM350C 34S/840 PSD PCS L1500 ALU	Aluminum
62449800	SM350C 50S/840 PSD PCS L1500 ALU	Aluminum
62441200	SM350C 34S/840 PSU PCS L1500 WH	White
62444300	SM350C 50S/840 PSU PCS L1500 WH	White
62447400	SM350C 34S/840 PSD PCS L1500 WH	White

Order Code	Full Product Name	Housing Color
62450400	SM350C 50S/840 PSD PCS L1500 WH	White
62430600	SM350C 40S/840 WIA PCS L1200 WH	White
62431300	SM350C 40S/840 WIA PCS L1200 BK	Black
62415300	SM350C 27S/840 PSU PCS L1200 WH	White
62418400	SM350C 40S/840 PSU PCS L1200 WH	White
62421400	SM350C 27S/840 PSD PCS L1200 WH	White
62424500	SM350C 40S/840 PSD PCS L1200 WH	White
62433700	SM350C 27S/830 PSU PCS L1200 WH	White
62435100	SM350C 40S/830 PSU PCS L1200 WH	White
62437500	SM350C 27S/830 PSD PCS L1200 WH	White
62439900	SM350C 40S/830 PSD PCS L1200 WH	White
62416000	SM350C 27S/840 PSU PCS L1200 BK	Black
62419100	SM350C 40S/840 PSU PCS L1200 BK	Black
62422100	SM350C 27S/840 PSD PCS L1200 BK	Black
62425200	SM350C 40S/840 PSD PCS L1200 BK	Black
62453500	SM350X 27S/840 PSD L60L60 PCS WH	White
61518200	SM351C 40S/840 PSU A PCS L1200 WH	White
61519900	SM351C 40S/840 PSD A PCS L1200 WH	White
61520500	SM351C 50S/840 PSU A PCS L1500 WH	White
61521200	SM351C 50S/840 PSD A PCS L1500 WH	White

Emergency Operation

Order Code	Full Product Name	Central Emergency
62454200	SM350X 27S/840 PSD PCS N BK	-
62442900	SM350C 34S/840 PSU PCS L1500 BK	-
62445000	SM350C 50S/840 PSU PCS L1500 BK	-
62448100	SM350C 34S/840 PSD PCS L1500 BK	-
62451100	SM350C 50S/840 PSD PCS L1500 BK	-
62367500	SM350C 27S/840 PSU PCS L1200 ALU	-
62417700	SM350C 40S/840 PSU PCS L1200 ALU	-

Order Code	Full Product Name	Central Emergency
62420700	SM350C 27S/840 PSD PCS L1200 ALU	-
62423800	SM350C 40S/840 PSD PCS L1200 ALU	-
62432000	SM350C 27S/830 PSU PCS L1200 ALU	-
62434400	SM350C 40S/830 PSU PCS L1200 ALU	-
62436800	SM350C 27S/830 PSD PCS L1200 ALU	-
62438200	SM350C 40S/830 PSD PCS L1200 ALU	-
62452800	SM350X 27S/840 PSD L60L60 PCS ALU	-

KeyLine, Surface & Suspended

Order Code	Full Product Name	Central Emergency
62440500	SM350C 34S/840 PSU PCS L1500 ALU	-
62443600	SM350C 50S/840 PSU PCS L1500 ALU	-
62446700	SM350C 34S/840 PSD PCS L1500 ALU	-
62449800	SM350C 50S/840 PSD PCS L1500 ALU	-
62441200	SM350C 34S/840 PSU PCS L1500 WH	-
62444300	SM350C 50S/840 PSU PCS L1500 WH	-
62447400	SM350C 34S/840 PSD PCS L1500 WH	-
62450400	SM350C 50S/840 PSD PCS L1500 WH	-
62430600	SM350C 40S/840 WIA PCS L1200 WH	-
62431300	SM350C 40S/840 WIA PCS L1200 BK	-
62415300	SM350C 27S/840 PSU PCS L1200 WH	-
62418400	SM350C 40S/840 PSU PCS L1200 WH	-
62421400	SM350C 27S/840 PSD PCS L1200 WH	-
62424500	SM350C 40S/840 PSD PCS L1200 WH	-

Order Code	Full Product Name	Central Emergency
62433700	SM350C 27S/830 PSU PCS L1200 WH	-
62435100	SM350C 40S/830 PSU PCS L1200 WH	-
62437500	SM350C 27S/830 PSD PCS L1200 WH	-
62439900	SM350C 40S/830 PSD PCS L1200 WH	-
62416000	SM350C 27S/840 PSU PCS L1200 BK	-
62419100	SM350C 40S/840 PSU PCS L1200 BK	-
62422100	SM350C 27S/840 PSD PCS L1200 BK	-
62425200	SM350C 40S/840 PSD PCS L1200 BK	-
62453500	SM350X 27S/840 PSD L60L60 PCS WH	-
61518200	SM351C 40S/840 PSU A PCS L1200 WH	No
61519900	SM351C 40S/840 PSD A PCS L1200 WH	No
61520500	SM351C 50S/840 PSU A PCS L1500 WH	No
61521200	SM351C 50S/840 PSD A PCS L1500 WH	No

Approval and Application

Order Code	Full Product Name	Flammability mark	Flickering value (PstLM) - Flickering value as per EN 61000-3-3
62454200	SM350X 27S/840 PSD PCS N BK	For mounting on normally flammable surfaces	1
62442900	SM350C 34S/840 PSU PCS L1500 BK	For mounting on normally flammable surfaces	1
62445000	SM350C 50S/840 PSU PCS L1500 BK	For mounting on normally flammable surfaces	1
62448100	SM350C 34S/840 PSD PCS L1500 BK	For mounting on normally flammable surfaces	1
62451100	SM350C 50S/840 PSD PCS L1500 BK	For mounting on normally flammable surfaces	1
62367500	SM350C 27S/840 PSU PCS L1200 ALU	For mounting on normally flammable surfaces	1
62417700	SM350C 40S/840 PSU PCS L1200 ALU	For mounting on normally flammable surfaces	1
62420700	SM350C 27S/840 PSD PCS L1200 ALU	For mounting on normally flammable surfaces	1
62423800	SM350C 40S/840 PSD PCS L1200 ALU	For mounting on normally flammable surfaces	1
62432000	SM350C 27S/830 PSU PCS L1200 ALU	For mounting on normally flammable surfaces	1
62434400	SM350C 40S/830 PSU PCS L1200 ALU	For mounting on normally flammable surfaces	1
62436800	SM350C 27S/830 PSD PCS L1200 ALU	For mounting on normally flammable surfaces	1
62438200	SM350C 40S/830 PSD PCS L1200 ALU	For mounting on normally flammable surfaces	1
62452800	SM350X 27S/840 PSD L60L60 PCS ALU	For mounting on normally flammable surfaces	1

Order Code	Full Product Name	Flammability mark	Flickering value (PstLM) - Flickering value as per EN 61000-3-3
62440500	SM350C 34S/840 PSU PCS L1500 ALU	For mounting on normally flammable surfaces	1
62443600	SM350C 50S/840 PSU PCS L1500 ALU	For mounting on normally flammable surfaces	1
62446700	SM350C 34S/840 PSD PCS L1500 ALU	For mounting on normally flammable surfaces	1
62449800	SM350C 50S/840 PSD PCS L1500 ALU	For mounting on normally flammable surfaces	1
62441200	SM350C 34S/840 PSU PCS L1500 WH	For mounting on normally flammable surfaces	1
62444300	SM350C 50S/840 PSU PCS L1500 WH	For mounting on normally flammable surfaces	1
62447400	SM350C 34S/840 PSD PCS L1500 WH	For mounting on normally flammable surfaces	1
62450400	SM350C 50S/840 PSD PCS L1500 WH	For mounting on normally flammable surfaces	1
62430600	SM350C 40S/840 WIA PCS L1200 WH	For mounting on normally flammable surfaces	1
62431300	SM350C 40S/840 WIA PCS L1200 BK	For mounting on normally flammable surfaces	1
62415300	SM350C 27S/840 PSU PCS L1200 WH	For mounting on normally flammable surfaces	1
62418400	SM350C 40S/840 PSU PCS L1200 WH	For mounting on normally flammable surfaces	1
62421400	SM350C 27S/840 PSD PCS L1200 WH	For mounting on normally flammable surfaces	1
62424500	SM350C 40S/840 PSD PCS L1200 WH	For mounting on normally flammable surfaces	1

KeyLine, Surface & Suspended

Order Code	Full Product Name	Flammability mark	Flickering value (PstLM) - Flickering value as per EN 61000-3-3
62433700	SM350C 27S/830 PSU PCS L1200 WH	For mounting on normally flammable surfaces	1
62435100	SM350C 40S/830 PSU PCS L1200 WH	For mounting on normally flammable surfaces	1
62437500	SM350C 27S/830 PSD PCS L1200 WH	For mounting on normally flammable surfaces	1
62439900	SM350C 40S/830 PSD PCS L1200 WH	For mounting on normally flammable surfaces	1
62416000	SM350C 27S/840 PSU PCS L1200 BK	For mounting on normally flammable surfaces	1
62419100	SM350C 40S/840 PSU PCS L1200 BK	For mounting on normally flammable surfaces	1
62422100	SM350C 27S/840 PSD PCS L1200 BK	For mounting on normally flammable surfaces	1

Order Code	Full Product Name	Flammability mark	Flickering value (PstLM) - Flickering value as per EN 61000-3-3
62425200	SM350C 40S/840 PSD PCS L1200 BK	For mounting on normally flammable surfaces	1
62453500	SM350X 27S/840 PSD L60L60 PCS WH	For mounting on normally flammable surfaces	1
61518200	SM351C 40S/840 PSU A PCS L1200 WH	-	-
61519900	SM351C 40S/840 PSD A PCS L1200 WH	-	-
61520500	SM351C 50S/840 PSU A PCS L1500 WH	-	-
61521200	SM351C 50S/840 PSD A PCS L1500 WH	-	-

Initial Performance (IEC Compliant)

Order Code	Full Product Name	Initial chromaticity
62454200	SM350X 27S/840 PSD PCS N BK	(0.39, 0.38) SDCM <3
62442900	SM350C 34S/840 PSU PCS L1500 BK	(0.39, 0.38) SDCM <3
62445000	SM350C 50S/840 PSU PCS L1500 BK	(0.39, 0.38) SDCM <3
62448100	SM350C 34S/840 PSD PCS L1500 BK	(0.39, 0.38) SDCM <3
62451100	SM350C 50S/840 PSD PCS L1500 BK	(0.39, 0.38) SDCM <3
62367500	SM350C 27S/840 PSU PCS L1200 ALU	(0.39, 0.38) SDCM <3
62417700	SM350C 40S/840 PSU PCS L1200 ALU	(0.39, 0.38) SDCM <3
62420700	SM350C 27S/840 PSD PCS L1200 ALU	(0.39, 0.38) SDCM <3
62423800	SM350C 40S/840 PSD PCS L1200 ALU	(0.39, 0.38) SDCM <3
62432000	SM350C 27S/830 PSU PCS L1200 ALU	(0.43, 0.40) SDCM <3
62434400	SM350C 40S/830 PSU PCS L1200 ALU	(0.43, 0.40) SDCM <3
62436800	SM350C 27S/830 PSD PCS L1200 ALU	(0.43, 0.40) SDCM <3
62438200	SM350C 40S/830 PSD PCS L1200 ALU	(0.43, 0.40) SDCM <3
62452800	SM350X 27S/840 PSD L60L60 PCS ALU	(0.39, 0.38) SDCM <3
62440500	SM350C 34S/840 PSU PCS L1500 ALU	(0.39, 0.38) SDCM <3
62443600	SM350C 50S/840 PSU PCS L1500 ALU	(0.39, 0.38) SDCM <3
62446700	SM350C 34S/840 PSD PCS L1500 ALU	(0.39, 0.38) SDCM <3
62449800	SM350C 50S/840 PSD PCS L1500 ALU	(0.39, 0.38) SDCM <3
62441200	SM350C 34S/840 PSU PCS L1500 WH	(0.39, 0.38) SDCM <3
62444300	SM350C 50S/840 PSU PCS L1500 WH	(0.39, 0.38) SDCM <3
62447400	SM350C 34S/840 PSD PCS L1500 WH	(0.39, 0.38) SDCM <3

Order Code	Full Product Name	Initial chromaticity
62450400	SM350C 50S/840 PSD PCS L1500 WH	(0.39, 0.38) SDCM <3
62430600	SM350C 40S/840 WIA PCS L1200 WH	(0.39, 0.38) SDCM <3
62431300	SM350C 40S/840 WIA PCS L1200 BK	(0.39, 0.38) SDCM <3
62415300	SM350C 27S/840 PSU PCS L1200 WH	(0.39, 0.38) SDCM <3
62418400	SM350C 40S/840 PSU PCS L1200 WH	(0.39, 0.38) SDCM <3
62421400	SM350C 27S/840 PSD PCS L1200 WH	(0.39, 0.38) SDCM <3
62424500	SM350C 40S/840 PSD PCS L1200 WH	(0.39, 0.38) SDCM <3
62433700	SM350C 27S/830 PSU PCS L1200 WH	(0.43, 0.40) SDCM <3
62435100	SM350C 40S/830 PSU PCS L1200 WH	(0.43, 0.40) SDCM <3
62437500	SM350C 27S/830 PSD PCS L1200 WH	(0.43, 0.40) SDCM <3
62439900	SM350C 40S/830 PSD PCS L1200 WH	(0.43, 0.40) SDCM <3
62416000	SM350C 27S/840 PSU PCS L1200 BK	(0.39, 0.38) SDCM <3
62419100	SM350C 40S/840 PSU PCS L1200 BK	(0.39, 0.38) SDCM <3
62422100	SM350C 27S/840 PSD PCS L1200 BK	(0.39, 0.38) SDCM <3
62425200	SM350C 40S/840 PSD PCS L1200 BK	(0.39, 0.38) SDCM <3
62453500	SM350X 27S/840 PSD L60L60 PCS WH	(0.39, 0.38) SDCM <3
61518200	SM351C 40S/840 PSU A PCS L1200 WH	(0.39, 0.38) SDCM <3
61519900	SM351C 40S/840 PSD A PCS L1200 WH	(0.39, 0.38) SDCM <3
61520500	SM351C 50S/840 PSU A PCS L1500 WH	(0.39, 0.38) SDCM <3
61521200	SM351C 50S/840 PSD A PCS L1500 WH	(0.39, 0.38) SDCM <3

Product Data

Order Code	Full Product Name	Product family code
62454200	SM350X 27S/840 PSD PCS N BK	SM350X
62442900	SM350C 34S/840 PSU PCS L1500 BK	SM350C
62445000	SM350C 50S/840 PSU PCS L1500 BK	SM350C

Order Code	Full Product Name	Product family code
62448100	SM350C 34S/840 PSD PCS L1500 BK	SM350C
62451100	SM350C 50S/840 PSD PCS L1500 BK	SM350C
62367500	SM350C 27S/840 PSU PCS L1200 ALU	SM350C

KeyLine, Surface & Suspended

Order Code	Full Product Name	Product family code
62417700	SM350C 40S/840 PSU PCS L1200 ALU	SM350C
62420700	SM350C 27S/840 PSD PCS L1200 ALU	SM350C
62423800	SM350C 40S/840 PSD PCS L1200 ALU	SM350C
62432000	SM350C 27S/830 PSU PCS L1200 ALU	SM350C
62434400	SM350C 40S/830 PSU PCS L1200 ALU	SM350C
62436800	SM350C 27S/830 PSD PCS L1200 ALU	SM350C
62438200	SM350C 40S/830 PSD PCS L1200 ALU	SM350C
62452800	SM350X 27S/840 PSD L60L60 PCS ALU	SM350X
62440500	SM350C 34S/840 PSU PCS L1500 ALU	SM350C
62443600	SM350C 50S/840 PSU PCS L1500 ALU	SM350C
62446700	SM350C 34S/840 PSD PCS L1500 ALU	SM350C
62449800	SM350C 50S/840 PSD PCS L1500 ALU	SM350C
62441200	SM350C 34S/840 PSU PCS L1500 WH	SM350C
62444300	SM350C 50S/840 PSU PCS L1500 WH	SM350C
62447400	SM350C 34S/840 PSD PCS L1500 WH	SM350C
62450400	SM350C 50S/840 PSD PCS L1500 WH	SM350C
62430600	SM350C 40S/840 WIA PCS L1200 WH	SM350C
62431300	SM350C 40S/840 WIA PCS L1200 BK	SM350C

Order Code	Full Product Name	Product family code
62415300	SM350C 27S/840 PSU PCS L1200 WH	SM350C
62418400	SM350C 40S/840 PSU PCS L1200 WH	SM350C
62421400	SM350C 27S/840 PSD PCS L1200 WH	SM350C
62424500	SM350C 40S/840 PSD PCS L1200 WH	SM350C
62433700	SM350C 27S/830 PSU PCS L1200 WH	SM350C
62435100	SM350C 40S/830 PSU PCS L1200 WH	SM350C
62437500	SM350C 27S/830 PSD PCS L1200 WH	SM350C
62439900	SM350C 40S/830 PSD PCS L1200 WH	SM350C
62416000	SM350C 27S/840 PSU PCS L1200 BK	SM350C
62419100	SM350C 40S/840 PSU PCS L1200 BK	SM350C
62422100	SM350C 27S/840 PSD PCS L1200 BK	SM350C
62425200	SM350C 40S/840 PSD PCS L1200 BK	SM350C
62453500	SM350X 27S/840 PSD L60L60 PCS WH	SM350X
61518200	SM351C 40S/840 PSU A PCS L1200 WH	SM350C
61519900	SM351C 40S/840 PSD A PCS L1200 WH	SM350C
61520500	SM351C 50S/840 PSU A PCS L1500 WH	SM350C
61521200	SM351C 50S/840 PSD A PCS L1500 WH	SM350C

Polar Wide Diagrams

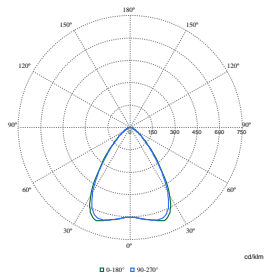

Polar Normal (separate) - SM350C1 - 910925868303

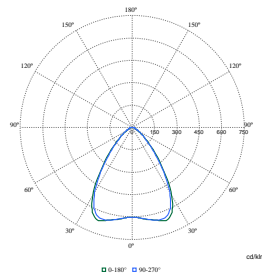

Polar Normal (separate) - SM350C1 - 910925868353

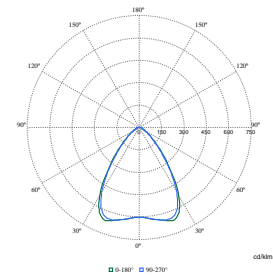

Polar Normal (separate) - SM350C1 - 910925868366

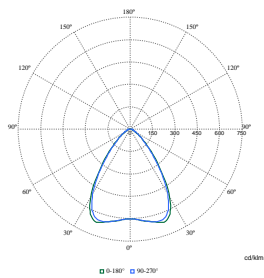

Polar Normal (separate) - SM350C1 - 910925868379

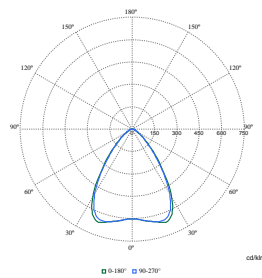

Polar Normal (separate) - SM350C1 - 910925868355

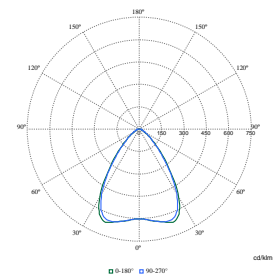

Polar Normal (separate) - SM350C1 - 910925868356

Polar Wide Diagrams

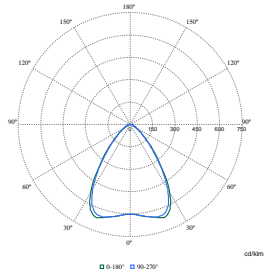

Polar Normal (separate) - SM350CI - 910925868383

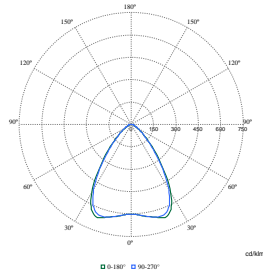

Polar Normal (separate) - SM350CI - 910925868352

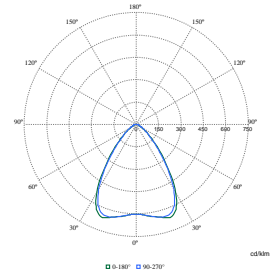

Polar Normal (separate) - SM350CI - 910925868359

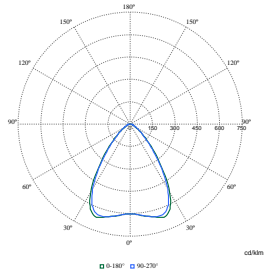

Polar Normal (separate) - SM350CI - 910925868375

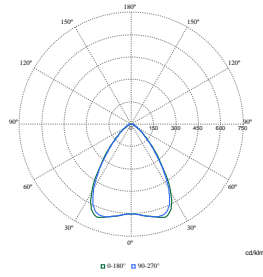

Polar Normal (separate) - SM350CI - 910925868381

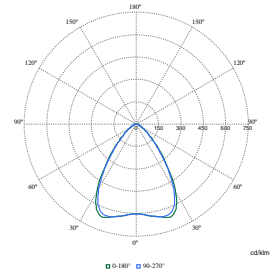

Polar Normal (separate) - SM350CI - 910925868385

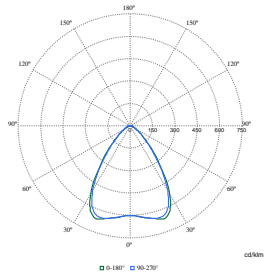

Polar Normal (separate) - SM350CI - 910925868388

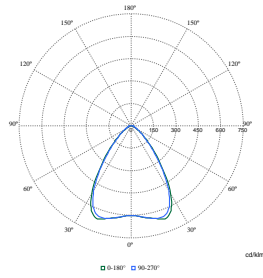

Polar Normal (separate) - SM350CI - 910925868389

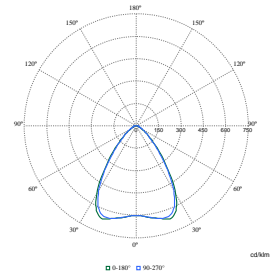

Polar Normal (separate) - SM350CI - 910925868354

Polar Wide Diagrams

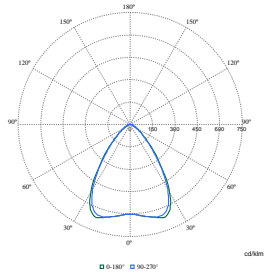

Polar Normal (separate) - SM350CI - 910925868387

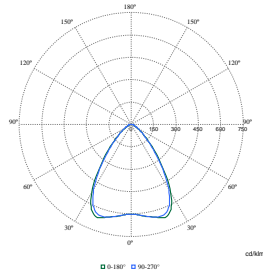

Polar Normal (separate) - SM350CI - 910925868370

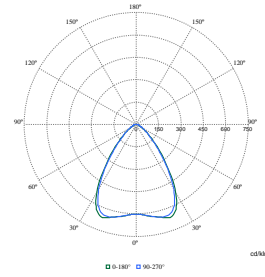

Polar Normal (separate) - SM350CI - 910925868384

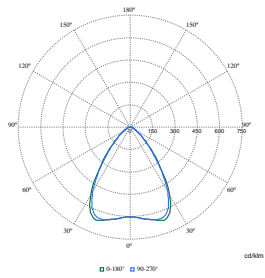

Polar Normal (separate) - SM350CI - 910925868386

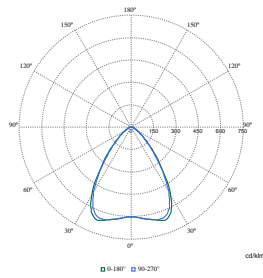

Polar Normal (separate) - SM350CI - 910925868360

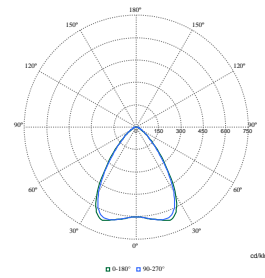

Polar Normal (separate) - SM350CI - 910925868361

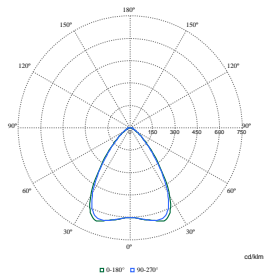

Polar Normal (separate) - SM350CI - 910925868367

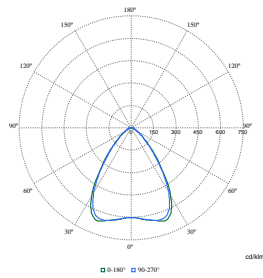

Polar Normal (separate) - SM350CI - 910925868357

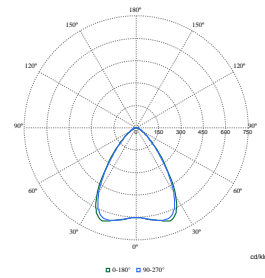

Polar Normal (separate) - SM350CI - 910925868368

Polar Wide Diagrams

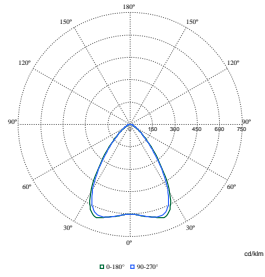

Polar Normal (separate) - SM350CI - 910925868358

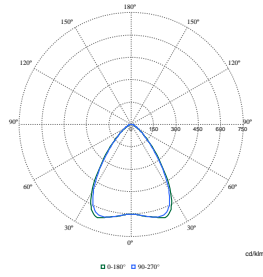

Polar Normal (separate) - SM350CI - 910925868372

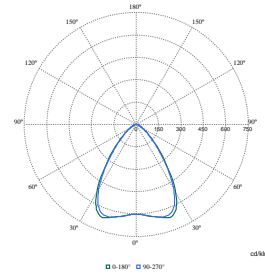

Polar Normal (separate) - SM350CI - 910925868376

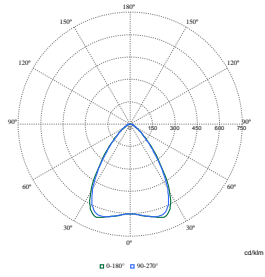

Polar Normal (separate) - SM350CI - 910925868378

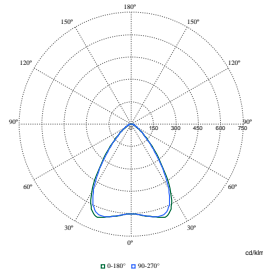

Polar Normal (separate) - SM350CI - 910925868380

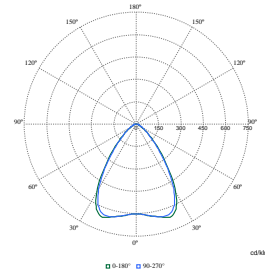

Polar Normal (separate) - SM350CI - 910925868351

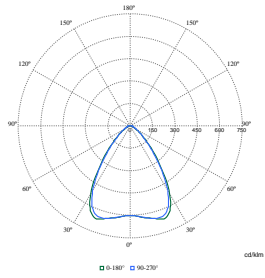

Polar Normal (separate) - SM350CI - 910925868369

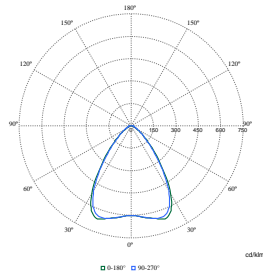

Polar Normal (separate) - SM350CI - 910925868371

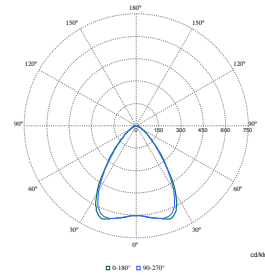

Polar Normal (separate) - SM350CI - 910925868374

KeyLine, Surface & Suspended

Polar Wide Diagrams

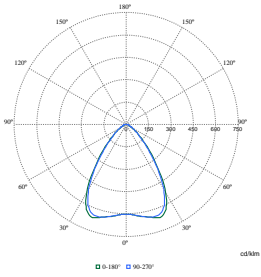

Polar Normal (separate) - SM350CI - 910925868373

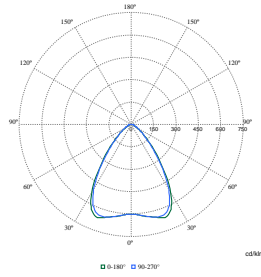

Polar Normal (separate) - SM350CI - 910925868377

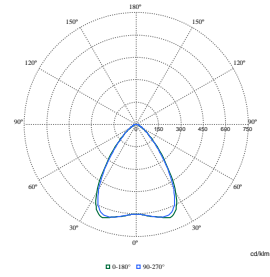

Polar Normal (separate) - SM350CI - 910925868382

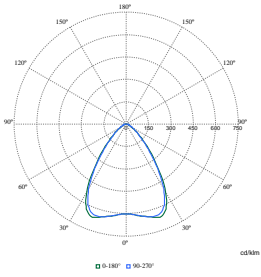

Polar Normal (separate) - SM350CI - 910925868390

