



The flexible light line

KeyLine, Surface & Suspended

These days, many office owners and office lighting designers prefer lines of light. The reason is simple. Not only do light lines come in a minimalistic design; they also offer far more choice and flexibility. Short or long lines and luminaires, standalone luminaires, different optics including asymmetric, different shapes and even a variety of colors; anything is possible. And with KeyLine, all these benefits come at a competitive price while still complying with office lighting norms. KeyLine is a superb light line range with a slim, minimalistic design and a high lumen output to illuminate the brightest office spaces. But with comfortable, low levels of glare it's also easy on the eye and complies with UGR19. That makes KeyLine ideal for linear applications, as well as standalone suspended or surface-mounted luminaires (Accessories to be ordered separately). A range that offers the ultimate flexibility and unlimited possibilities. KeyLine design flexibility comes in the form of different lengths, colors and light outputs - including L-shapes, as well as straight lines. All with high efficiency up to 142 lm/W, and the option to upgrade with wireless connectivity and control. Add to that attractive pricing, and with KeyLine you can also enjoy excellent value that ensures a superb total cost of ownership.

Benefits

- Suitable for office applications
- Excellent total cost of ownership
- Wide range of options to suit the demands of different offices

Features

- Comfortable, low glare: <UGR19 for the full range
- High lumen output, up to 4000lm for 1.2m version
- Interact Connectivity ready with wireless drivers
- Standard options in different lengths, colors and light outputs
- Customization options

KeyLine, Surface & Suspended

Application

- Offices
- Retail
- Education

Warnings and Safety

- KeyLine luminaires have an IP20 classification and are not protected against water ingress. We strongly recommend that the installation environment is checked for suitability.
- If – despite the IPX0 classification warning – luminaires are subject to water ingress, Philips and Signify cannot guarantee safety or prevent failure. In this case the product warranty does not apply and becomes void.

Versions



KeyLine L-corner, black



KeyLine L-corner, alu



KeyLine L-corner, white

Dimensional drawing

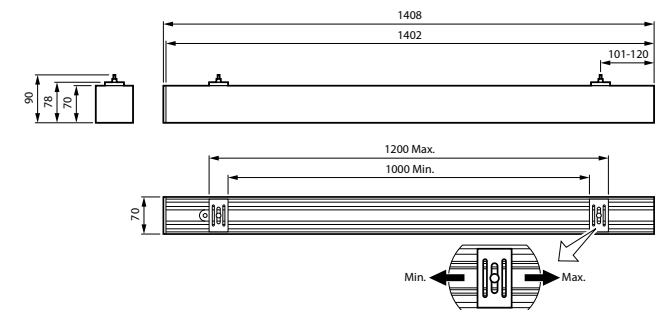
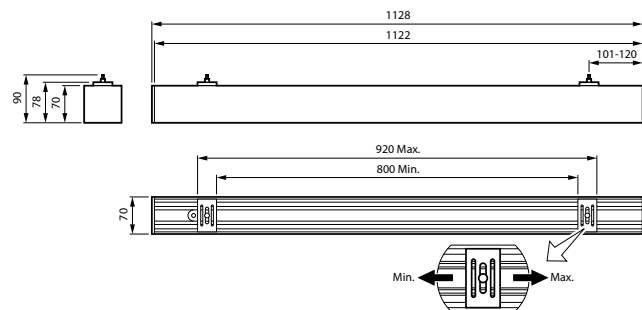
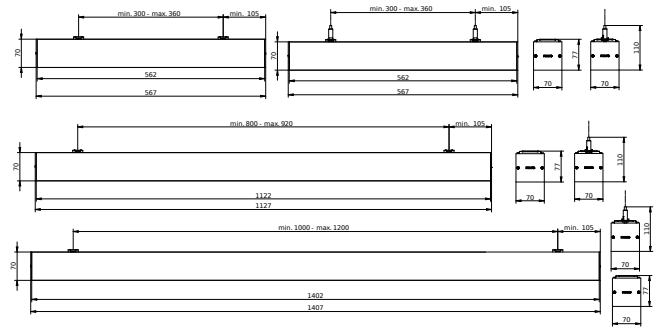
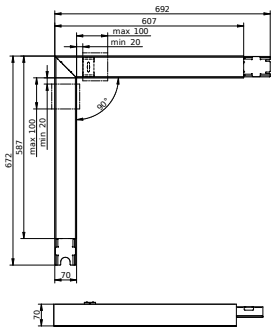

KeyLine, Surface & Suspended

Product details



KeyLine line coupling, alu



KeyLine black with ceiling bracket accessory for surface mounting

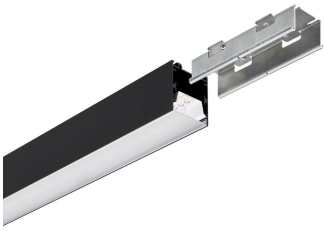

KeyLine black with coupling piece accessory for line mounting



KeyLine Asymmetric SM531C detailed



KeyLine_SM350C_WIA_DPP1



KeyLine line configuration, white



KeyLine SM350C, white



KeyLine configuration with L-corner SM350X



KeyLine black with end-cap accessory



KeyLine line coupling, white

KeyLine, Surface & Suspended

Product details



KeyLine alu with suspension set for suspended mounting

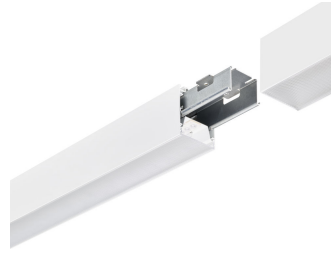

KeyLine white line coupling with coupling piece accessory



KeyLine_SM350C_WIA_DPP3



KeyLine alu with end-cap accessory



KeyLine white with coupling piece accessory for line mounting



KeyLine structured optics UGR19 (PCS)



KeyLine line coupling, black



KeyLine SM350C, alu

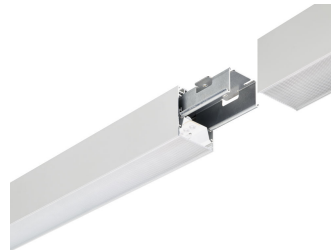

KeyLine alu line coupling with coupling piece accessory

KeyLine, Surface & Suspended

Product details



KeyLine line configuration, black



KeyLine alu with ceiling bracket accessory for surface mounting



KeyLine white with suspension set for suspended mounting



KeyLine white with ceiling bracket accessory for surface mounting



KeyLine white with end-cap accessory



KeyLine alu with coupling piece accessory for line mounting



KeyLine SM350C, black

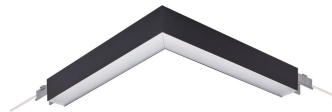

KeyLine L-corner, black

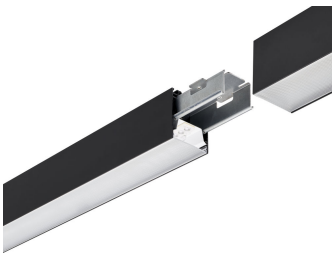

KeyLine black line coupling with coupling piece accessory



KeyLine black with suspension set for suspended mounting



KeyLine_SM350C_WIA_DPP2

KeyLine, Surface & Suspended

Product details

KeyLine L-corner, alu



KeyLine L-corner, white



General Information	
Driver included	Yes
Number of gear units	1 unit
Service tag	Yes
Light Technical	
Color rendering index (CRI)	>80
Operating and Electrical	
Protection class IEC	Safety class I
Line Frequency	50 to 60 Hz
Mechanical and Housing	
Mech. impact protection code	IK06
Ingress protection code	IP20
Approval and Application	
Ambient temperature range	+10 to +35 °C
CE mark	Yes
ENEC mark	ENEC mark
Glow-wire test	Temperature 650 °C, duration 30 s
Stroboscopic effect visibility measure (SVM)	0.4
Initial Performance (IEC Compliant)	
Luminous flux tolerance	+/-10%

General Information

Order Code	Full Product Name	Light source replaceable
910925868390	SM350X 27S/840 PSD PCS N BK	No
910925868378	SM350C 34S/840 PSU PCS L1500 BK	No
910925868381	SM350C 50S/840 PSU PCS L1500 BK	No
910925868384	SM350C 34S/840 PSD PCS L1500 BK	No
910925868387	SM350C 50S/840 PSD PCS L1500 BK	No
910925868303	SM350C 27S/840 PSU PCS L1200 ALU	No
910925868353	SM350C 40S/840 PSU PCS L1200 ALU	No
910925868356	SM350C 27S/840 PSD PCS L1200 ALU	No
910925868359	SM350C 40S/840 PSD PCS L1200 ALU	No
910925868368	SM350C 27S/830 PSU PCS L1200 ALU	No
910925868370	SM350C 40S/830 PSU PCS L1200 ALU	No
910925868372	SM350C 27S/830 PSD PCS L1200 ALU	No
910925868374	SM350C 40S/830 PSD PCS L1200 ALU	No
910925868388	SM350X 27S/840 PSD L60L60 PCS ALU	No
910925868376	SM350C 34S/840 PSU PCS L1500 ALU	No
910925868379	SM350C 50S/840 PSU PCS L1500 ALU	No
910925868382	SM350C 34S/840 PSD PCS L1500 ALU	No
910925868385	SM350C 50S/840 PSD PCS L1500 ALU	No
910925868377	SM350C 34S/840 PSU PCS L1500 WH	No
910925868380	SM350C 50S/840 PSU PCS L1500 WH	No
910925868383	SM350C 34S/840 PSD PCS L1500 WH	No
910925868386	SM350C 50S/840 PSD PCS L1500 WH	No
910925868362	SM350C 27S/840 WIA PCS L1200 ALU	No
910925868363	SM350C 27S/840 WIA PCS L1200 WH	No
910925868364	SM350C 27S/840 WIA PCS L1200 BK	No
910925868365	SM350C 40S/840 WIA PCS L1200 ALU	No
910925868366	SM350C 40S/840 WIA PCS L1200 WH	No
910925868367	SM350C 40S/840 WIA PCS L1200 BK	No
910925868351	SM350C 27S/840 PSU PCS L1200 WH	No
910925868354	SM350C 40S/840 PSU PCS L1200 WH	No
910925868357	SM350C 27S/840 PSD PCS L1200 WH	No
910925868360	SM350C 40S/840 PSD PCS L1200 WH	No
910925868369	SM350C 27S/830 PSU PCS L1200 WH	No
910925868371	SM350C 40S/830 PSU PCS L1200 WH	No
910925868373	SM350C 27S/830 PSD PCS L1200 WH	No
910925868375	SM350C 40S/830 PSD PCS L1200 WH	No
910925868352	SM350C 27S/840 PSU PCS L1200 BK	No
910925868355	SM350C 40S/840 PSU PCS L1200 BK	No
910925868358	SM350C 27S/840 PSD PCS L1200 BK	No

KeyLine, Surface & Suspended

Order Code	Full Product Name	Light source replaceable
910925868361	SM350C 40S/840 PSD PCS L1200 BK	No
910925868389	SM350X 27S/840 PSD L60L60 PCS WH	No
910505103701	SM351C 40S/840 PSU A PCS L1200 WH	-
910505103702	SM351C 40S/840 PSD A PCS L1200 WH	-
910505103703	SM351C 50S/840 PSU A PCS L1500 WH	-
910505103704	SM351C 50S/840 PSD A PCS L1500 WH	-

Light Technical (1/2)

Order Code	Full Product Name	Beam angle of light source	Correlated Color Temperature (Nom)	Luminous Efficacy (rated) (Nom)	Luminous Flux
910925868390	SM350X 27S/840 PSD PCS N BK	120 degree(s)	4000 K	135 lm/W	2,700 lm
910925868378	SM350C 34S/840 PSU PCS L1500 BK	120 degree(s)	4000 K	142 lm/W	3,400 lm
910925868381	SM350C 50S/840 PSU PCS L1500 BK	120 degree(s)	4000 K	135 lm/W	5,000 lm
910925868384	SM350C 34S/840 PSD PCS L1500 BK	120 degree(s)	4000 K	136 lm/W	3,400 lm
910925868387	SM350C 50S/840 PSD PCS L1500 BK	120 degree(s)	4000 K	135 lm/W	5,000 lm
910925868303	SM350C 27S/840 PSU PCS L1200 ALU	120 degree(s)	4000 K	138 lm/W	2,700 lm
910925868353	SM350C 40S/840 PSU PCS L1200 ALU	120 degree(s)	4000 K	133 lm/W	4,000 lm
910925868356	SM350C 27S/840 PSD PCS L1200 ALU	120 degree(s)	4000 K	135 lm/W	2,700 lm
910925868359	SM350C 40S/840 PSD PCS L1200 ALU	120 degree(s)	4000 K	133 lm/W	4,000 lm
910925868368	SM350C 27S/830 PSU PCS L1200 ALU	120 degree(s)	3000 K	132 lm/W	2,700 lm
910925868370	SM350C 40S/830 PSU PCS L1200 ALU	120 degree(s)	3000 K	133 lm/W	4,000 lm

Order Code	Full Product Name	Beam angle of light source	Correlated Color Temperature (Nom)	Luminous Efficacy (rated) (Nom)	Luminous Flux
910925868372	SM350C 27S/830 PSD PCS L1200 ALU	120 degree(s)	3000 K	135 lm/W	2,700 lm
910925868374	SM350C 40S/830 PSD PCS L1200 ALU	120 degree(s)	3000 K	129 lm/W	4,000 lm
910925868388	SM350X 27S/840 PSD L60L60 PCS ALU	120 degree(s)	4000 K	135 lm/W	2,700 lm
910925868376	SM350C 34S/840 PSU PCS L1500 ALU	120 degree(s)	4000 K	142 lm/W	3,400 lm
910925868379	SM350C 50S/840 PSU PCS L1500 ALU	120 degree(s)	4000 K	135 lm/W	5,000 lm
910925868382	SM350C 34S/840 PSD PCS L1500 ALU	120 degree(s)	4000 K	136 lm/W	3,400 lm
910925868385	SM350C 50S/840 PSD PCS L1500 ALU	120 degree(s)	4000 K	135 lm/W	5,000 lm
910925868377	SM350C 34S/840 PSU PCS L1500 WH	120 degree(s)	4000 K	142 lm/W	3,400 lm
910925868380	SM350C 50S/840 PSU PCS L1500 WH	120 degree(s)	4000 K	135 lm/W	5,000 lm
910925868383	SM350C 34S/840 PSD PCS L1500 WH	120 degree(s)	4000 K	136 lm/W	3,400 lm

KeyLine, Surface & Suspended

Order Code	Full Product Name	Beam angle of light source	Correlated Color Temperature (Nom)	Luminous Efficacy (rated) (Nom)	Luminous Flux
910925868386	SM350C 50S/840 PSD PCS L1500 WH	120 degree(s)	4000 K	135 lm/W	5,000 lm
910925868362	SM350C 27S/840 WIA PCS L1200 ALU	120 degree(s)	4000 K	138 lm/W	2,700 lm
910925868363	SM350C 27S/840 WIA PCS L1200 WH	120 degree(s)	4000 K	138 lm/W	2,700 lm
910925868364	SM350C 27S/840 WIA PCS L1200 BK	120 degree(s)	4000 K	138 lm/W	2,700 lm
910925868365	SM350C 40S/840 WIA PCS L1200 ALU	120 degree(s)	4000 K	133 lm/W	4,000 lm
910925868366	SM350C 40S/840 WIA PCS L1200 WH	120 degree(s)	4000 K	133 lm/W	4,000 lm
910925868367	SM350C 40S/840 WIA PCS L1200 BK	120 degree(s)	4000 K	133 lm/W	4,000 lm
910925868351	SM350C 27S/840 PSU PCS L1200 WH	120 degree(s)	4000 K	138 lm/W	2,700 lm
910925868354	SM350C 40S/840 PSU PCS L1200 WH	120 degree(s)	4000 K	133 lm/W	4,000 lm
910925868357	SM350C 27S/840 PSD PCS L1200 WH	120 degree(s)	4000 K	135 lm/W	2,700 lm
910925868360	SM350C 40S/840 PSD PCS L1200 WH	120 degree(s)	4000 K	133 lm/W	4,000 lm
910925868369	SM350C 27S/830 PSU PCS L1200 WH	120 degree(s)	3000 K	132 lm/W	2,700 lm
910925868371	SM350C 40S/830 PSU PCS L1200 WH	120 degree(s)	3000 K	133 lm/W	4,000 lm

Order Code	Full Product Name	Beam angle of light source	Correlated Color Temperature (Nom)	Luminous Efficacy (rated) (Nom)	Luminous Flux
910925868373	SM350C 27S/830 PSD PCS L1200 WH	120 degree(s)	3000 K	135 lm/W	2,700 lm
910925868375	SM350C 40S/830 PSD PCS L1200 WH	120 degree(s)	3000 K	129 lm/W	4,000 lm
910925868352	SM350C 27S/840 PSU PCS L1200 BK	120 degree(s)	4000 K	138 lm/W	2,700 lm
910925868355	SM350C 40S/840 PSU PCS L1200 BK	120 degree(s)	4000 K	133 lm/W	4,000 lm
910925868358	SM350C 27S/840 PSD PCS L1200 BK	120 degree(s)	4000 K	135 lm/W	2,700 lm
910925868361	SM350C 40S/840 PSD PCS L1200 BK	120 degree(s)	4000 K	133 lm/W	4,000 lm
910925868389	SM350X 27S/840 PSD L60L60 PCS WH	120 degree(s)	4000 K	135 lm/W	2,700 lm
910505103701	SM351C 40S/840 PSU A PCS L1200 WH	-	4000 K	133 lm/W	4,000 lm
910505103702	SM351C 40S/840 PSD A PCS L1200 WH	-	4000 K	133 lm/W	4,000 lm
910505103703	SM351C 50S/840 PSU A PCS L1500 WH	-	4000 K	135 lm/W	5,000 lm
910505103704	SM351C 50S/840 PSD A PCS L1500 WH	-	4000 K	132 lm/W	5,000 lm

Light Technical (2/2)

Order Code	Full Product Name	Optic type
910925868390	SM350X 27S/840 PSD PCS N BK	Medium beam
910925868378	SM350C 34S/840 PSU PCS L1500 BK	Medium beam
910925868381	SM350C 50S/840 PSU PCS L1500 BK	Medium beam
910925868384	SM350C 34S/840 PSD PCS L1500 BK	Medium beam

Order Code	Full Product Name	Optic type
910925868387	SM350C 50S/840 PSD PCS L1500 BK	Medium beam
910925868303	SM350C 27S/840 PSU PCS L1200 ALU	Medium beam
910925868353	SM350C 40S/840 PSU PCS L1200 ALU	Medium beam
910925868356	SM350C 27S/840 PSD PCS L1200 ALU	Medium beam

KeyLine, Surface & Suspended

Order Code	Full Product Name	Optic type
910925868359	SM350C 40S/840 PSD PCS L1200 ALU	Medium beam
910925868368	SM350C 27S/830 PSU PCS L1200 ALU	Medium beam
910925868370	SM350C 40S/830 PSU PCS L1200 ALU	Medium beam
910925868372	SM350C 27S/830 PSD PCS L1200 ALU	Medium beam
910925868374	SM350C 40S/830 PSD PCS L1200 ALU	Medium beam
910925868388	SM350X 27S/840 PSD L60L60 PCS ALU	Medium beam
910925868376	SM350C 34S/840 PSU PCS L1500 ALU	Medium beam
910925868379	SM350C 50S/840 PSU PCS L1500 ALU	Medium beam
910925868382	SM350C 34S/840 PSD PCS L1500 ALU	Medium beam
910925868385	SM350C 50S/840 PSD PCS L1500 ALU	Medium beam
910925868377	SM350C 34S/840 PSU PCS L1500 WH	Medium beam
910925868380	SM350C 50S/840 PSU PCS L1500 WH	Medium beam
910925868383	SM350C 34S/840 PSD PCS L1500 WH	Medium beam
910925868386	SM350C 50S/840 PSD PCS L1500 WH	Medium beam
910925868362	SM350C 27S/840 WIA PCS L1200 ALU	Medium beam
910925868363	SM350C 27S/840 WIA PCS L1200 WH	Medium beam
910925868364	SM350C 27S/840 WIA PCS L1200 BK	Medium beam
910925868365	SM350C 40S/840 WIA PCS L1200 ALU	Medium beam
910925868366	SM350C 40S/840 WIA PCS L1200 WH	Medium beam

Order Code	Full Product Name	Optic type
910925868367	SM350C 40S/840 WIA PCS L1200 BK	Medium beam
910925868351	SM350C 27S/840 PSU PCS L1200 WH	Medium beam
910925868354	SM350C 40S/840 PSU PCS L1200 WH	Medium beam
910925868357	SM350C 27S/840 PSD PCS L1200 WH	Medium beam
910925868360	SM350C 40S/840 PSD PCS L1200 WH	Medium beam
910925868369	SM350C 27S/830 PSU PCS L1200 WH	Medium beam
910925868371	SM350C 40S/830 PSU PCS L1200 WH	Medium beam
910925868373	SM350C 27S/830 PSD PCS L1200 WH	Medium beam
910925868375	SM350C 40S/830 PSD PCS L1200 WH	Medium beam
910925868352	SM350C 27S/840 PSU PCS L1200 BK	Medium beam
910925868355	SM350C 40S/840 PSU PCS L1200 BK	Medium beam
910925868358	SM350C 27S/840 PSD PCS L1200 BK	Medium beam
910925868361	SM350C 40S/840 PSD PCS L1200 BK	Medium beam
910925868389	SM350X 27S/840 PSD L60L60 PCS WH	Medium beam
910505103701	SM351C 40S/840 PSU A PCS L1200 WH	Assymetric Beam angle
910505103702	SM351C 40S/840 PSD A PCS L1200 WH	Assymetric Beam angle
910505103703	SM351C 50S/840 PSU A PCS L1500 WH	Assymetric Beam angle
910505103704	SM351C 50S/840 PSD A PCS L1500 WH	Assymetric Beam angle

Operating and Electrical

Order Code	Full Product Name	Power		Suitable for random switching
		Input Voltage	Consumption	
910925868390	SM350X 27S/840 PSD PCS N BK	220 to 240 V	21 W	No
910925868378	SM350C 34S/840 PSU PCS L1500 BK	220 to 240 V	25 W	No
910925868381	SM350C 50S/840 PSU PCS L1500 BK	220 to 240 V	36.5 W	No
910925868384	SM350C 34S/840 PSD PCS L1500 BK	220 to 240 V	26 W	No
910925868387	SM350C 50S/840 PSD PCS L1500 BK	220 to 240 V	38 W	No
910925868303	SM350C 27S/840 PSU PCS L1200 ALU	220 to 240 V	20.5 W	No
910925868353	SM350C 40S/840 PSU PCS L1200 ALU	220 to 240 V	30 W	No
910925868356	SM350C 27S/840 PSD PCS L1200 ALU	220 to 240 V	21 W	No
910925868359	SM350C 40S/840 PSD PCS L1200 ALU	220 to 240 V	31 W	No
910925868368	SM350C 27S/830 PSU PCS L1200 ALU	220 to 240 V	20.5 W	No
910925868370	SM350C 40S/830 PSU PCS L1200 ALU	220 to 240 V	30 W	No
910925868372	SM350C 27S/830 PSD PCS L1200 ALU	220 to 240 V	21 W	No
910925868374	SM350C 40S/830 PSD PCS L1200 ALU	220 to 240 V	31 W	No

Order Code	Full Product Name	Power		Suitable for random switching
		Input Voltage	Consumption	
910925868388	SM350X 27S/840 PSD L60L60 PCS ALU	220 to 240 V	21 W	No
910925868376	SM350C 34S/840 PSU PCS L1500 ALU	220 to 240 V	25 W	No
910925868379	SM350C 50S/840 PSU PCS L1500 ALU	220 to 240 V	36.5 W	No
910925868382	SM350C 34S/840 PSD PCS L1500 ALU	220 to 240 V	26 W	No
910925868385	SM350C 50S/840 PSD PCS L1500 ALU	220 to 240 V	38 W	No
910925868377	SM350C 34S/840 PSU PCS L1500 WH	220 to 240 V	25 W	No
910925868380	SM350C 50S/840 PSU PCS L1500 WH	220 to 240 V	36.5 W	No
910925868383	SM350C 34S/840 PSD PCS L1500 WH	220 to 240 V	26 W	No
910925868386	SM350C 50S/840 PSD PCS L1500 WH	220 to 240 V	38 W	No
910925868362	SM350C 27S/840 WIA PCS L1200 ALU	220 to 240 V	20.5 W	No
910925868363	SM350C 27S/840 WIA PCS L1200 WH	220 to 240 V	20.5 W	No
910925868364	SM350C 27S/840 WIA PCS L1200 BK	220 to 240 V	20.5 W	No
910925868365	SM350C 40S/840 WIA PCS L1200 ALU	220 to 240 V	30 W	No

KeyLine, Surface & Suspended

Order Code	Full Product Name	Input Voltage	Power		Suitable for random switching
			Consumption		
910925868366	SM350C 40S/840 WIA PCS L1200 WH	220 to 240 V	30 W		No
910925868367	SM350C 40S/840 WIA PCS L1200 BK	220 to 240 V	30 W		No
910925868351	SM350C 27S/840 PSU PCS L1200 WH	220 to 240 V	20.5 W		No
910925868354	SM350C 40S/840 PSU PCS L1200 WH	220 to 240 V	30 W		No
910925868357	SM350C 27S/840 PSD PCS L1200 WH	220 to 240 V	21 W		No
910925868360	SM350C 40S/840 PSD PCS L1200 WH	220 to 240 V	31 W		No
910925868369	SM350C 27S/830 PSU PCS L1200 WH	220 to 240 V	20.5 W		No
910925868371	SM350C 40S/830 PSU PCS L1200 WH	220 to 240 V	30 W		No
910925868373	SM350C 27S/830 PSD PCS L1200 WH	220 to 240 V	21 W		No
910925868375	SM350C 40S/830 PSD PCS L1200 WH	220 to 240 V	31 W		No

Order Code	Full Product Name	Input Voltage	Power		Suitable for random switching
			Consumption		
910925868352	SM350C 27S/840 PSU PCS L1200 BK	220 to 240 V	20.5 W		No
910925868355	SM350C 40S/840 PSU PCS L1200 BK	220 to 240 V	30 W		No
910925868358	SM350C 27S/840 PSD PCS L1200 BK	220 to 240 V	21 W		No
910925868361	SM350C 40S/840 PSD PCS L1200 BK	220 to 240 V	31 W		No
910925868389	SM350X 27S/840 PSD L60L60 PCS WH	220 to 240 V	21 W		No
910505103701	SM351C 40S/840 PSU A PCS L1200 WH	220-240 V	30 W		Not applicable
910505103702	SM351C 40S/840 PSD A PCS L1200 WH	220-240 V	31 W		Not applicable
910505103703	SM351C 50S/840 PSU A PCS L1500 WH	220-240 V	37 W		Not applicable
910505103704	SM351C 50S/840 PSD A PCS L1500 WH	220-240 V	38 W		Not applicable

Controls and Dimming

Order Code	Full Product Name	Dimmable	Maximum dim	
			level	
910925868390	SM350X 27S/840 PSD PCS N BK	Yes	1%	
910925868378	SM350C 34S/840 PSU PCS L1500 BK	No	Not applicable	
910925868381	SM350C 50S/840 PSU PCS L1500 BK	No	Not applicable	
910925868384	SM350C 34S/840 PSD PCS L1500 BK	Yes	1%	
910925868387	SM350C 50S/840 PSD PCS L1500 BK	Yes	1%	
910925868303	SM350C 27S/840 PSU PCS L1200 ALU	No	Not applicable	
910925868353	SM350C 40S/840 PSU PCS L1200 ALU	No	Not applicable	
910925868356	SM350C 27S/840 PSD PCS L1200 ALU	Yes	1%	
910925868359	SM350C 40S/840 PSD PCS L1200 ALU	Yes	1%	
910925868368	SM350C 27S/830 PSU PCS L1200 ALU	No	Not applicable	
910925868370	SM350C 40S/830 PSU PCS L1200 ALU	No	Not applicable	
910925868372	SM350C 27S/830 PSD PCS L1200 ALU	Yes	1%	
910925868374	SM350C 40S/830 PSD PCS L1200 ALU	Yes	1%	
910925868388	SM350X 27S/840 PSD L60L60 PCS ALU	Yes	1%	
910925868376	SM350C 34S/840 PSU PCS L1500 ALU	No	Not applicable	
910925868379	SM350C 50S/840 PSU PCS L1500 ALU	No	Not applicable	
910925868382	SM350C 34S/840 PSD PCS L1500 ALU	Yes	1%	
910925868385	SM350C 50S/840 PSD PCS L1500 ALU	Yes	1%	
910925868377	SM350C 34S/840 PSU PCS L1500 WH	No	Not applicable	
910925868380	SM350C 50S/840 PSU PCS L1500 WH	No	Not applicable	
910925868383	SM350C 34S/840 PSD PCS L1500 WH	Yes	1%	
910925868386	SM350C 50S/840 PSD PCS L1500 WH	Yes	1%	
910925868362	SM350C 27S/840 WIA PCS L1200 ALU	No	1%	

Order Code	Full Product Name	Dimmable	Maximum dim	
			level	
910925868363	SM350C 27S/840 WIA PCS L1200 WH	No	1%	
910925868364	SM350C 27S/840 WIA PCS L1200 BK	No	1%	
910925868365	SM350C 40S/840 WIA PCS L1200 ALU	No	1%	
910925868366	SM350C 40S/840 WIA PCS L1200 WH	No	1%	
910925868367	SM350C 40S/840 WIA PCS L1200 BK	No	1%	
910925868351	SM350C 27S/840 PSU PCS L1200 WH	No	Not applicable	
910925868354	SM350C 40S/840 PSU PCS L1200 WH	No	Not applicable	
910925868357	SM350C 27S/840 PSD PCS L1200 WH	Yes	1%	
910925868360	SM350C 40S/840 PSD PCS L1200 WH	Yes	1%	
910925868369	SM350C 27S/830 PSU PCS L1200 WH	No	Not applicable	
910925868371	SM350C 40S/830 PSU PCS L1200 WH	No	Not applicable	
910925868373	SM350C 27S/830 PSD PCS L1200 WH	Yes	1%	
910925868375	SM350C 40S/830 PSD PCS L1200 WH	Yes	1%	
910925868352	SM350C 27S/840 PSU PCS L1200 BK	No	Not applicable	
910925868355	SM350C 40S/840 PSU PCS L1200 BK	No	Not applicable	
910925868358	SM350C 27S/840 PSD PCS L1200 BK	Yes	1%	
910925868361	SM350C 40S/840 PSD PCS L1200 BK	Yes	1%	
910925868389	SM350X 27S/840 PSD L60L60 PCS WH	Yes	1%	
910505103701	SM351C 40S/840 PSU A PCS L1200 WH	No	Not applicable	
910505103702	SM351C 40S/840 PSD A PCS L1200 WH	-	1%	
910505103703	SM351C 50S/840 PSU A PCS L1500 WH	No	Not applicable	
910505103704	SM351C 50S/840 PSD A PCS L1500 WH	-	1%	

Mechanical and Housing

KeyLine, Surface & Suspended

Order Code	Full Product Name	Housing Color
910925868390	SM350X 27S/840 PSD PCS N BK	Black
910925868378	SM350C 34S/840 PSU PCS L1500 BK	Black
910925868381	SM350C 50S/840 PSU PCS L1500 BK	Black
910925868384	SM350C 34S/840 PSD PCS L1500 BK	Black
910925868387	SM350C 50S/840 PSD PCS L1500 BK	Black
910925868303	SM350C 27S/840 PSU PCS L1200 ALU	Aluminum
910925868353	SM350C 40S/840 PSU PCS L1200 ALU	Aluminum
910925868356	SM350C 27S/840 PSD PCS L1200 ALU	Aluminum
910925868359	SM350C 40S/840 PSD PCS L1200 ALU	Aluminum
910925868368	SM350C 27S/830 PSU PCS L1200 ALU	Aluminum
910925868370	SM350C 40S/830 PSU PCS L1200 ALU	Aluminum
910925868372	SM350C 27S/830 PSD PCS L1200 ALU	Aluminum
910925868374	SM350C 40S/830 PSD PCS L1200 ALU	Aluminum
910925868388	SM350X 27S/840 PSD L60L60 PCS ALU	Aluminum
910925868376	SM350C 34S/840 PSU PCS L1500 ALU	Aluminum
910925868379	SM350C 50S/840 PSU PCS L1500 ALU	Aluminum
910925868382	SM350C 34S/840 PSD PCS L1500 ALU	Aluminum
910925868385	SM350C 50S/840 PSD PCS L1500 ALU	Aluminum
910925868377	SM350C 34S/840 PSU PCS L1500 WH	White
910925868380	SM350C 50S/840 PSU PCS L1500 WH	White
910925868383	SM350C 34S/840 PSD PCS L1500 WH	White
910925868386	SM350C 50S/840 PSD PCS L1500 WH	White
910925868362	SM350C 27S/840 WIA PCS L1200 ALU	Aluminum

Order Code	Full Product Name	Housing Color
910925868363	SM350C 27S/840 WIA PCS L1200 WH	White
910925868364	SM350C 27S/840 WIA PCS L1200 BK	Black
910925868365	SM350C 40S/840 WIA PCS L1200 ALU	Aluminum
910925868366	SM350C 40S/840 WIA PCS L1200 WH	White
910925868367	SM350C 40S/840 WIA PCS L1200 BK	Black
910925868351	SM350C 27S/840 PSU PCS L1200 WH	White
910925868354	SM350C 40S/840 PSU PCS L1200 WH	White
910925868357	SM350C 27S/840 PSD PCS L1200 WH	White
910925868360	SM350C 40S/840 PSD PCS L1200 WH	White
910925868369	SM350C 27S/830 PSU PCS L1200 WH	White
910925868371	SM350C 40S/830 PSU PCS L1200 WH	White
910925868373	SM350C 27S/830 PSD PCS L1200 WH	White
910925868375	SM350C 40S/830 PSD PCS L1200 WH	White
910925868352	SM350C 27S/840 PSU PCS L1200 BK	Black
910925868355	SM350C 40S/840 PSU PCS L1200 BK	Black
910925868358	SM350C 27S/840 PSD PCS L1200 BK	Black
910925868361	SM350C 40S/840 PSD PCS L1200 BK	Black
910925868389	SM350X 27S/840 PSD L60L60 PCS WH	White
910505103701	SM351C 40S/840 PSU A PCS L1200 WH	White
910505103702	SM351C 40S/840 PSD A PCS L1200 WH	White
910505103703	SM351C 50S/840 PSU A PCS L1500 WH	White
910505103704	SM351C 50S/840 PSD A PCS L1500 WH	White

Emergency Operation

Order Code	Full Product Name	Central Emergency
910925868390	SM350X 27S/840 PSD PCS N BK	-
910925868378	SM350C 34S/840 PSU PCS L1500 BK	-
910925868381	SM350C 50S/840 PSU PCS L1500 BK	-
910925868384	SM350C 34S/840 PSD PCS L1500 BK	-
910925868387	SM350C 50S/840 PSD PCS L1500 BK	-
910925868303	SM350C 27S/840 PSU PCS L1200 ALU	-
910925868353	SM350C 40S/840 PSU PCS L1200 ALU	-
910925868356	SM350C 27S/840 PSD PCS L1200 ALU	-
910925868359	SM350C 40S/840 PSD PCS L1200 ALU	-
910925868368	SM350C 27S/830 PSU PCS L1200 ALU	-
910925868370	SM350C 40S/830 PSU PCS L1200 ALU	-
910925868372	SM350C 27S/830 PSD PCS L1200 ALU	-
910925868374	SM350C 40S/830 PSD PCS L1200 ALU	-
910925868388	SM350X 27S/840 PSD L60L60 PCS ALU	-
910925868376	SM350C 34S/840 PSU PCS L1500 ALU	-
910925868379	SM350C 50S/840 PSU PCS L1500 ALU	-
910925868382	SM350C 34S/840 PSD PCS L1500 ALU	-
910925868385	SM350C 50S/840 PSD PCS L1500 ALU	-
910925868377	SM350C 34S/840 PSU PCS L1500 WH	-
910925868380	SM350C 50S/840 PSU PCS L1500 WH	-
910925868383	SM350C 34S/840 PSD PCS L1500 WH	-
910925868386	SM350C 50S/840 PSD PCS L1500 WH	-
910925868362	SM350C 27S/840 WIA PCS L1200 ALU	-

Order Code	Full Product Name	Central Emergency
910925868363	SM350C 27S/840 WIA PCS L1200 WH	-
910925868364	SM350C 27S/840 WIA PCS L1200 BK	-
910925868365	SM350C 40S/840 WIA PCS L1200 ALU	-
910925868366	SM350C 40S/840 WIA PCS L1200 WH	-
910925868367	SM350C 40S/840 WIA PCS L1200 BK	-
910925868351	SM350C 27S/840 PSU PCS L1200 WH	-
910925868354	SM350C 40S/840 PSU PCS L1200 WH	-
910925868357	SM350C 27S/840 PSD PCS L1200 WH	-
910925868360	SM350C 40S/840 PSD PCS L1200 WH	-
910925868369	SM350C 27S/830 PSU PCS L1200 WH	-
910925868371	SM350C 40S/830 PSU PCS L1200 WH	-
910925868373	SM350C 27S/830 PSD PCS L1200 WH	-
910925868375	SM350C 40S/830 PSD PCS L1200 WH	-
910925868352	SM350C 27S/840 PSU PCS L1200 BK	-
910925868355	SM350C 40S/840 PSU PCS L1200 BK	-
910925868358	SM350C 27S/840 PSD PCS L1200 BK	-
910925868361	SM350C 40S/840 PSD PCS L1200 BK	-
910925868389	SM350X 27S/840 PSD L60L60 PCS WH	-
910505103701	SM351C 40S/840 PSU A PCS L1200 WH	No
910505103702	SM351C 40S/840 PSD A PCS L1200 WH	No
910505103703	SM351C 50S/840 PSU A PCS L1500 WH	No
910505103704	SM351C 50S/840 PSD A PCS L1500 WH	No

Approval and Application

KeyLine, Surface & Suspended

Order Code	Full Product Name	Flammability mark	Flickering value (PstLM) - Flickering value as per EN 61000-3-3
910925868390	SM350X 27S/840 PSD PCS N BK	For mounting on normally flammable surfaces	1
910925868378	SM350C 34S/840 PSU PCS L1500 BK	For mounting on normally flammable surfaces	1
910925868381	SM350C 50S/840 PSU PCS L1500 BK	For mounting on normally flammable surfaces	1
910925868384	SM350C 34S/840 PSD PCS L1500 BK	For mounting on normally flammable surfaces	1
910925868387	SM350C 50S/840 PSD PCS L1500 BK	For mounting on normally flammable surfaces	1
910925868303	SM350C 27S/840 PSU PCS L1200 ALU	For mounting on normally flammable surfaces	1
910925868353	SM350C 40S/840 PSU PCS L1200 ALU	For mounting on normally flammable surfaces	1
910925868356	SM350C 27S/840 PSD PCS L1200 ALU	For mounting on normally flammable surfaces	1
910925868359	SM350C 40S/840 PSD PCS L1200 ALU	For mounting on normally flammable surfaces	1
910925868368	SM350C 27S/830 PSU PCS L1200 ALU	For mounting on normally flammable surfaces	1
910925868370	SM350C 40S/830 PSU PCS L1200 ALU	For mounting on normally flammable surfaces	1
910925868372	SM350C 27S/830 PSD PCS L1200 ALU	For mounting on normally flammable surfaces	1
910925868374	SM350C 40S/830 PSD PCS L1200 ALU	For mounting on normally flammable surfaces	1
910925868388	SM350X 27S/840 PSD L60L60 PCS ALU	For mounting on normally flammable surfaces	1
910925868376	SM350C 34S/840 PSU PCS L1500 ALU	For mounting on normally flammable surfaces	1
910925868379	SM350C 50S/840 PSU PCS L1500 ALU	For mounting on normally flammable surfaces	1
910925868382	SM350C 34S/840 PSD PCS L1500 ALU	For mounting on normally flammable surfaces	1
910925868385	SM350C 50S/840 PSD PCS L1500 ALU	For mounting on normally flammable surfaces	1
910925868377	SM350C 34S/840 PSU PCS L1500 WH	For mounting on normally flammable surfaces	1
910925868380	SM350C 50S/840 PSU PCS L1500 WH	For mounting on normally flammable surfaces	1
910925868383	SM350C 34S/840 PSD PCS L1500 WH	For mounting on normally flammable surfaces	1
910925868386	SM350C 50S/840 PSD PCS L1500 WH	For mounting on normally flammable surfaces	1
910925868362	SM350C 27S/840 WIA PCS L1200 ALU	For mounting on normally flammable surfaces	1

Order Code	Full Product Name	Flammability mark	Flickering value (PstLM) - Flickering value as per EN 61000-3-3
910925868363	SM350C 27S/840 WIA PCS L1200 WH	For mounting on normally flammable surfaces	1
910925868364	SM350C 27S/840 WIA PCS L1200 BK	For mounting on normally flammable surfaces	1
910925868365	SM350C 40S/840 WIA PCS L1200 ALU	For mounting on normally flammable surfaces	1
910925868366	SM350C 40S/840 WIA PCS L1200 WH	For mounting on normally flammable surfaces	1
910925868367	SM350C 40S/840 WIA PCS L1200 BK	For mounting on normally flammable surfaces	1
910925868351	SM350C 27S/840 PSU PCS L1200 WH	For mounting on normally flammable surfaces	1
910925868354	SM350C 40S/840 PSU PCS L1200 WH	For mounting on normally flammable surfaces	1
910925868357	SM350C 27S/840 PSD PCS L1200 WH	For mounting on normally flammable surfaces	1
910925868360	SM350C 40S/840 PSD PCS L1200 WH	For mounting on normally flammable surfaces	1
910925868369	SM350C 27S/830 PSU PCS L1200 WH	For mounting on normally flammable surfaces	1
910925868371	SM350C 40S/830 PSU PCS L1200 WH	For mounting on normally flammable surfaces	1
910925868373	SM350C 27S/830 PSD PCS L1200 WH	For mounting on normally flammable surfaces	1
910925868375	SM350C 40S/830 PSD PCS L1200 WH	For mounting on normally flammable surfaces	1
910925868352	SM350C 27S/840 PSU PCS L1200 BK	For mounting on normally flammable surfaces	1
910925868355	SM350C 40S/840 PSU PCS L1200 BK	For mounting on normally flammable surfaces	1
910925868358	SM350C 27S/840 PSD PCS L1200 BK	For mounting on normally flammable surfaces	1
910925868361	SM350C 40S/840 PSD PCS L1200 BK	For mounting on normally flammable surfaces	1
910925868389	SM350X 27S/840 PSD L60L60 PCS WH	For mounting on normally flammable surfaces	1
910505103701	SM351C 40S/840 PSU A PCS L1200 WH	-	-
910505103702	SM351C 40S/840 PSD A PCS L1200 WH	-	-
910505103703	SM351C 50S/840 PSU A PCS L1500 WH	-	-
910505103704	SM351C 50S/840 PSD A PCS L1500 WH	-	-

Initial Performance (IEC Compliant)

KeyLine, Surface & Suspended

Order Code	Full Product Name	Initial chromaticity
910925868390	SM350X 27S/840 PSD PCS N BK	(0.39, 0.38) SDCM <3
910925868378	SM350C 34S/840 PSU PCS L1500 BK	(0.39, 0.38) SDCM <3
910925868381	SM350C 50S/840 PSU PCS L1500 BK	(0.39, 0.38) SDCM <3
910925868384	SM350C 34S/840 PSD PCS L1500 BK	(0.39, 0.38) SDCM <3
910925868387	SM350C 50S/840 PSD PCS L1500 BK	(0.39, 0.38) SDCM <3
910925868303	SM350C 27S/840 PSU PCS L1200 ALU	(0.39, 0.38) SDCM <3
910925868353	SM350C 40S/840 PSU PCS L1200 ALU	(0.39, 0.38) SDCM <3
910925868356	SM350C 27S/840 PSD PCS L1200 ALU	(0.39, 0.38) SDCM <3
910925868359	SM350C 40S/840 PSD PCS L1200 ALU	(0.39, 0.38) SDCM <3
910925868368	SM350C 27S/830 PSU PCS L1200 ALU	(0.43, 0.40) SDCM <3
910925868370	SM350C 40S/830 PSU PCS L1200 ALU	(0.43, 0.40) SDCM <3
910925868372	SM350C 27S/830 PSD PCS L1200 ALU	(0.43, 0.40) SDCM <3
910925868374	SM350C 40S/830 PSD PCS L1200 ALU	(0.43, 0.40) SDCM <3
910925868388	SM350X 27S/840 PSD L60L60 PCS ALU	(0.39, 0.38) SDCM <3
910925868376	SM350C 34S/840 PSU PCS L1500 ALU	(0.39, 0.38) SDCM <3
910925868379	SM350C 50S/840 PSU PCS L1500 ALU	(0.39, 0.38) SDCM <3
910925868382	SM350C 34S/840 PSD PCS L1500 ALU	(0.39, 0.38) SDCM <3
910925868385	SM350C 50S/840 PSD PCS L1500 ALU	(0.39, 0.38) SDCM <3
910925868377	SM350C 34S/840 PSU PCS L1500 WH	(0.39, 0.38) SDCM <3
910925868380	SM350C 50S/840 PSU PCS L1500 WH	(0.39, 0.38) SDCM <3
910925868383	SM350C 34S/840 PSD PCS L1500 WH	(0.39, 0.38) SDCM <3
910925868386	SM350C 50S/840 PSD PCS L1500 WH	(0.39, 0.38) SDCM <3
910925868362	SM350C 27S/840 WIA PCS L1200 ALU	(0.39, 0.38) SDCM <3

Order Code	Full Product Name	Initial chromaticity
910925868363	SM350C 27S/840 WIA PCS L1200 WH	(0.39, 0.38) SDCM <3
910925868364	SM350C 27S/840 WIA PCS L1200 BK	(0.39, 0.38) SDCM <3
910925868365	SM350C 40S/840 WIA PCS L1200 ALU	(0.39, 0.38) SDCM <3
910925868366	SM350C 40S/840 WIA PCS L1200 WH	(0.39, 0.38) SDCM <3
910925868367	SM350C 40S/840 WIA PCS L1200 BK	(0.39, 0.38) SDCM <3
910925868351	SM350C 27S/840 PSU PCS L1200 WH	(0.39, 0.38) SDCM <3
910925868354	SM350C 40S/840 PSU PCS L1200 WH	(0.39, 0.38) SDCM <3
910925868357	SM350C 27S/840 PSD PCS L1200 WH	(0.39, 0.38) SDCM <3
910925868360	SM350C 40S/840 PSD PCS L1200 WH	(0.39, 0.38) SDCM <3
910925868369	SM350C 27S/830 PSU PCS L1200 WH	(0.43, 0.40) SDCM <3
910925868371	SM350C 40S/830 PSU PCS L1200 WH	(0.43, 0.40) SDCM <3
910925868373	SM350C 27S/830 PSD PCS L1200 WH	(0.43, 0.40) SDCM <3
910925868375	SM350C 40S/830 PSD PCS L1200 WH	(0.43, 0.40) SDCM <3
910925868352	SM350C 27S/840 PSU PCS L1200 BK	(0.39, 0.38) SDCM <3
910925868355	SM350C 40S/840 PSU PCS L1200 BK	(0.39, 0.38) SDCM <3
910925868358	SM350C 27S/840 PSD PCS L1200 BK	(0.39, 0.38) SDCM <3
910925868361	SM350C 40S/840 PSD PCS L1200 BK	(0.39, 0.38) SDCM <3
910925868389	SM350X 27S/840 PSD L60L60 PCS WH	(0.39, 0.38) SDCM <3
910505103701	SM351C 40S/840 PSU A PCS L1200 WH	(0.39, 0.38) SDCM <3
910505103702	SM351C 40S/840 PSD A PCS L1200 WH	(0.39, 0.38) SDCM <3
910505103703	SM351C 50S/840 PSU A PCS L1500 WH	(0.39, 0.38) SDCM <3
910505103704	SM351C 50S/840 PSD A PCS L1500 WH	(0.39, 0.38) SDCM <3

Product Data

Order Code	Full Product Name	Product family code
910925868390	SM350X 27S/840 PSD PCS N BK	SM350X
910925868378	SM350C 34S/840 PSU PCS L1500 BK	SM350C
910925868381	SM350C 50S/840 PSU PCS L1500 BK	SM350C
910925868384	SM350C 34S/840 PSD PCS L1500 BK	SM350C
910925868387	SM350C 50S/840 PSD PCS L1500 BK	SM350C
910925868303	SM350C 27S/840 PSU PCS L1200 ALU	SM350C
910925868353	SM350C 40S/840 PSU PCS L1200 ALU	SM350C
910925868356	SM350C 27S/840 PSD PCS L1200 ALU	SM350C
910925868359	SM350C 40S/840 PSD PCS L1200 ALU	SM350C
910925868368	SM350C 27S/830 PSU PCS L1200 ALU	SM350C
910925868370	SM350C 40S/830 PSU PCS L1200 ALU	SM350C
910925868372	SM350C 27S/830 PSD PCS L1200 ALU	SM350C
910925868374	SM350C 40S/830 PSD PCS L1200 ALU	SM350C
910925868388	SM350X 27S/840 PSD L60L60 PCS ALU	SM350X
910925868376	SM350C 34S/840 PSU PCS L1500 ALU	SM350C
910925868379	SM350C 50S/840 PSU PCS L1500 ALU	SM350C
910925868382	SM350C 34S/840 PSD PCS L1500 ALU	SM350C
910925868385	SM350C 50S/840 PSD PCS L1500 ALU	SM350C
910925868377	SM350C 34S/840 PSU PCS L1500 WH	SM350C
910925868380	SM350C 50S/840 PSU PCS L1500 WH	SM350C
910925868383	SM350C 34S/840 PSD PCS L1500 WH	SM350C
910925868386	SM350C 50S/840 PSD PCS L1500 WH	SM350C
910925868362	SM350C 27S/840 WIA PCS L1200 ALU	SM350C

Order Code	Full Product Name	Product family code
910925868363	SM350C 27S/840 WIA PCS L1200 WH	SM350C
910925868364	SM350C 27S/840 WIA PCS L1200 BK	SM350C
910925868365	SM350C 40S/840 WIA PCS L1200 ALU	SM350C
910925868366	SM350C 40S/840 WIA PCS L1200 WH	SM350C
910925868367	SM350C 40S/840 WIA PCS L1200 BK	SM350C
910925868351	SM350C 27S/840 PSU PCS L1200 WH	SM350C
910925868354	SM350C 40S/840 PSU PCS L1200 WH	SM350C
910925868357	SM350C 27S/840 PSD PCS L1200 WH	SM350C
910925868360	SM350C 40S/840 PSD PCS L1200 WH	SM350C
910925868369	SM350C 27S/830 PSU PCS L1200 WH	SM350C
910925868371	SM350C 40S/830 PSU PCS L1200 WH	SM350C
910925868373	SM350C 27S/830 PSD PCS L1200 WH	SM350C
910925868375	SM350C 40S/830 PSD PCS L1200 WH	SM350C
910925868352	SM350C 27S/840 PSU PCS L1200 BK	SM350C
910925868355	SM350C 40S/840 PSU PCS L1200 BK	SM350C
910925868358	SM350C 27S/840 PSD PCS L1200 BK	SM350C
910925868361	SM350C 40S/840 PSD PCS L1200 BK	SM350C
910925868389	SM350X 27S/840 PSD L60L60 PCS WH	SM350X
910505103701	SM351C 40S/840 PSU A PCS L1200 WH	SM350C
910505103702	SM351C 40S/840 PSD A PCS L1200 WH	SM350C
910505103703	SM351C 50S/840 PSU A PCS L1500 WH	SM350C
910505103704	SM351C 50S/840 PSD A PCS L1500 WH	SM350C

Polar Wide Diagrams

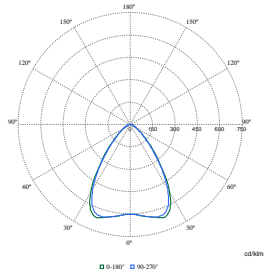

Polar Normal (separate) - SM350CI - 910925868303

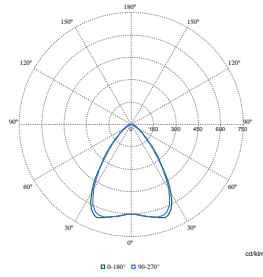

Polar Normal (separate) - SM350CI - 910925868353

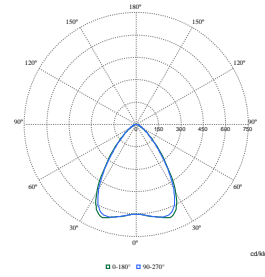

Polar Normal (separate) - SM350CI - 910925868366

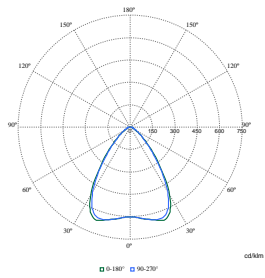

Polar Normal (separate) - SM350CI - 910925868379

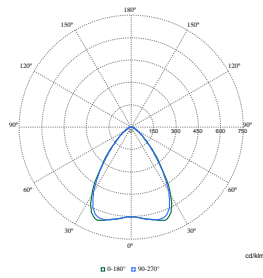

Polar Normal (separate) - SM350CI - 910925868355

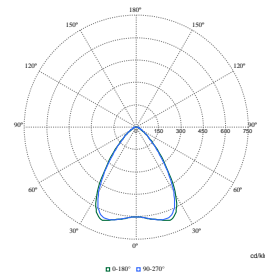

Polar Normal (separate) - SM350CI - 910925868356

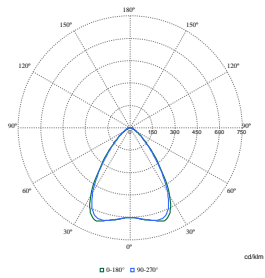

Polar Normal (separate) - SM350CI - 910925868383

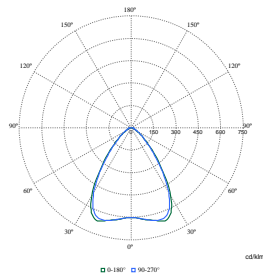

Polar Normal (separate) - SM350CI - 910925868352

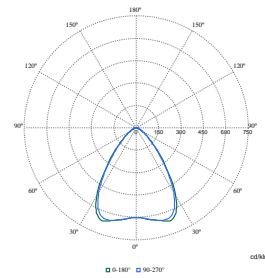

Polar Normal (separate) - SM350CI - 910925868359

Polar Wide Diagrams

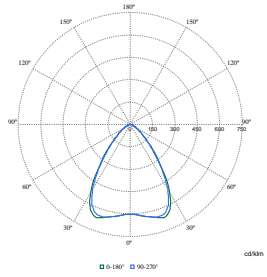

Polar Normal (separate) - SM350CI - 910925868363

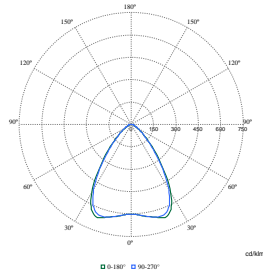

Polar Normal (separate) - SM350CI - 910925868375

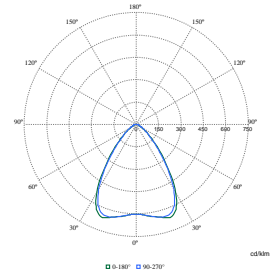

Polar Normal (separate) - SM350CI - 910925868381

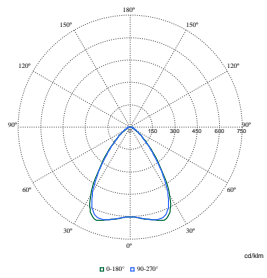

Polar Normal (separate) - SM350CI - 910925868385

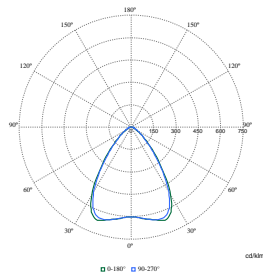

Polar Normal (separate) - SM350CI - 910925868388

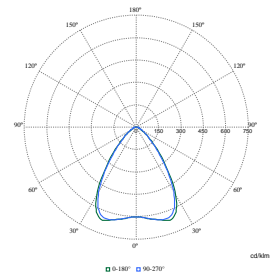

Polar Normal (separate) - SM350CI - 910925868389

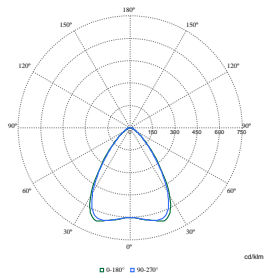

Polar Normal (separate) - SM350CI - 910925868354

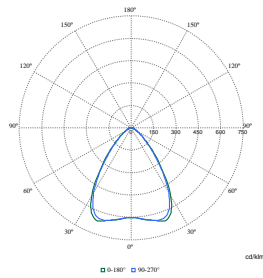

Polar Normal (separate) - SM350CI - 910925868387

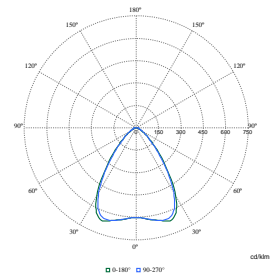

Polar Normal (separate) - SM350CI - 910925868362

Polar Wide Diagrams

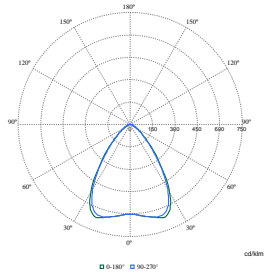

Polar Normal (separate) - SM350CI - 910925868365

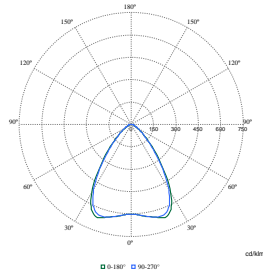

Polar Normal (separate) - SM350CI - 910925868370

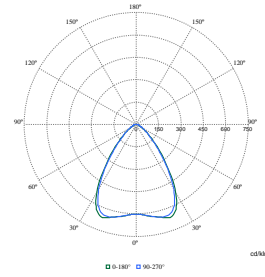

Polar Normal (separate) - SM350CI - 910925868384

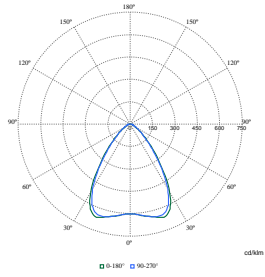

Polar Normal (separate) - SM350CI - 910925868386

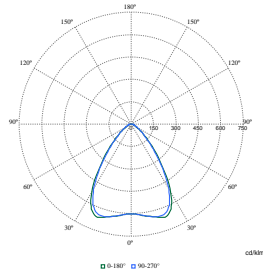

Polar Normal (separate) - SM350CI - 910925868360

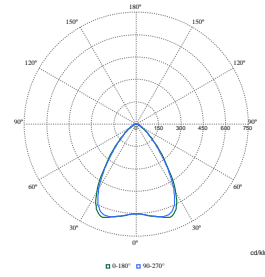

Polar Normal (separate) - SM350CI - 910925868361

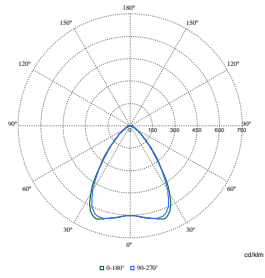

Polar Normal (separate) - SM350CI - 910925868367

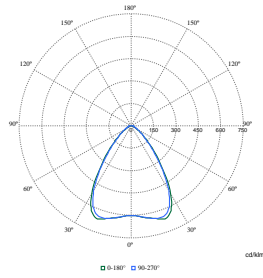

Polar Normal (separate) - SM350CI - 910925868357

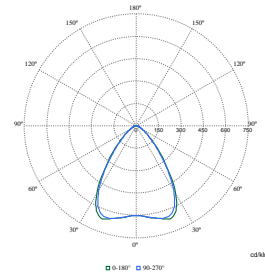

Polar Normal (separate) - SM350CI - 910925868368

Polar Wide Diagrams

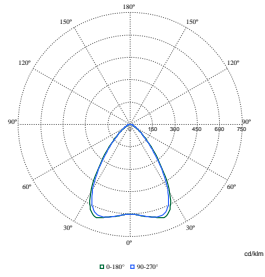

Polar Normal (separate) - SM350CI - 910925868358

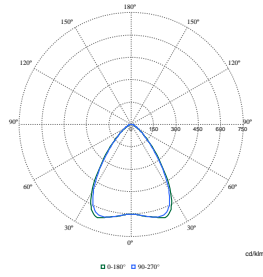

Polar Normal (separate) - SM350CI - 910925868364

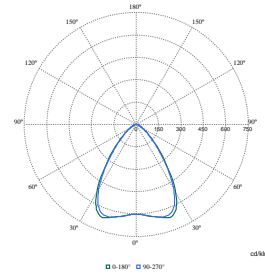

Polar Normal (separate) - SM350CI - 910925868372

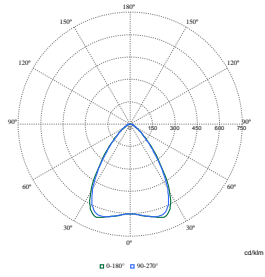

Polar Normal (separate) - SM350CI - 910925868376

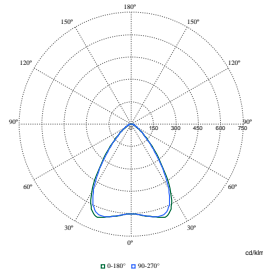

Polar Normal (separate) - SM350CI - 910925868378

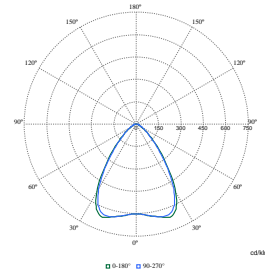

Polar Normal (separate) - SM350CI - 910925868380

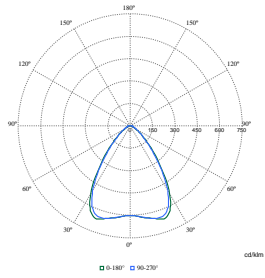

Polar Normal (separate) - SM350CI - 910925868351

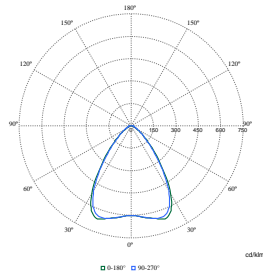

Polar Normal (separate) - SM350CI - 910925868369

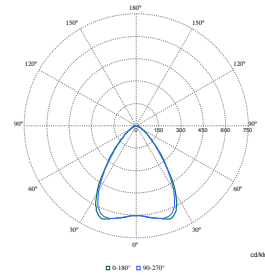

Polar Normal (separate) - SM350CI - 910925868371

KeyLine, Surface & Suspended

Polar Wide Diagrams

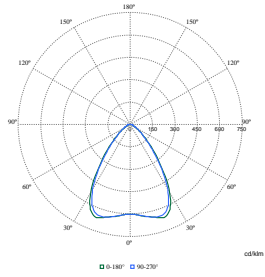

Polar Normal (separate) - SM350CI - 910925868374

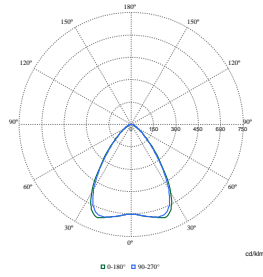

Polar Normal (separate) - SM350CI - 910925868373

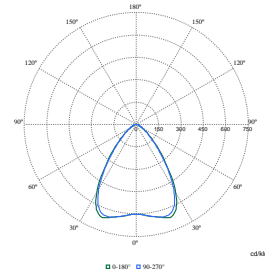

Polar Normal (separate) - SM350CI - 910925868377

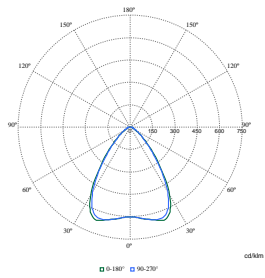

Polar Normal (separate) - SM350CI - 910925868382

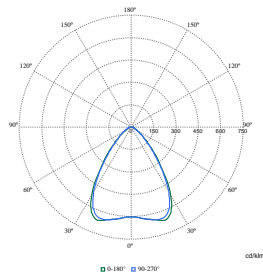

Polar Normal (separate) - SM350CI - 910925868390

