



# Install smarter, finish sooner Choose long-lasting reliability and performance

## CoreLine Recessed Spot gen2

CoreLine Recessed Spot gen2 delivers on the CoreLine promise of innovative, easy to use and high-quality luminaires. Its modular design allows “configure to fit” option that better responds to your specific needs. The range offers a wide range choice on light color (CCT), light output, color finish, frame types and connectivity options. The compact and lite design of CoreLine Recessed Spot gen2, always incorporating a push in connector allowing loop in/out wiring and supporting a wide range of wire diameters/cross-sectional area, makes installation hassle-free. High quality of light, numerous connectivity options, long luminaire lifetime and high system efficacy makes CoreLine Recessed Spot gen2 an ideal accent solution for your indoor spot lighting applications.

### Benefits

- Diversity thanks to modular design, responding to a wide range of needs
- Notably easy to install and maintain
- Compact and lite product design with high quality materials and finish
- Good quality of light
- Good Performance
- Good value for money

# CoreLine Recessed Spot gen2

## Features

- Available in fixed or adjustable versions
- CE, UKCA and ENEC certified
- White, Black or Aluminium finish
- 650, 900 or 1200 lumens (system output)
- L70 at 50.000h
- System efficacy of 88 to 107 lm/w, depending on configuration
- Color Rendering Index, CRI >80
- Standard Color Deviation, SDCM < 3
- Correlated Light Color Temperature of 2700K, 3000K or 4000K
- Led Modules with sparkly lens optics
- Chip-on-board LED light source
- Various interchangeable frame accessories
- All configurations support basic insulation coverability as per IEC 60598-1.edit 8.1
- Various connectivity options: Phase-Cut (PSR), DALI (PSD) or Interact Pro (WIA)
- High Performance Dimming driver (PSR) compatible with most wall-dimmers in the market
- Halox® 100 concrete installation housing compatible options available

## Application

- Hospitality
- Retail
- Offices
- Residential
- HoReCa
- Wide range of General Indoor applications
- Corridors
- Meeting rooms
- Bathrooms and toilets
- Break-out areas
- Shelf and cabinets

## Warnings and Safety

- The luminaire should be installed and disassembled by a qualified electrician and wired in accordance with the latest IEE electrical regulations or the national requirements, as per the product mounting instructions.

## Versions



CoreLine Recessed Spot gen2  
D68mm 650-950-1200lm  
Adjustable WH SPP

# CoreLine Recessed Spot gen2

## Dimensional drawing

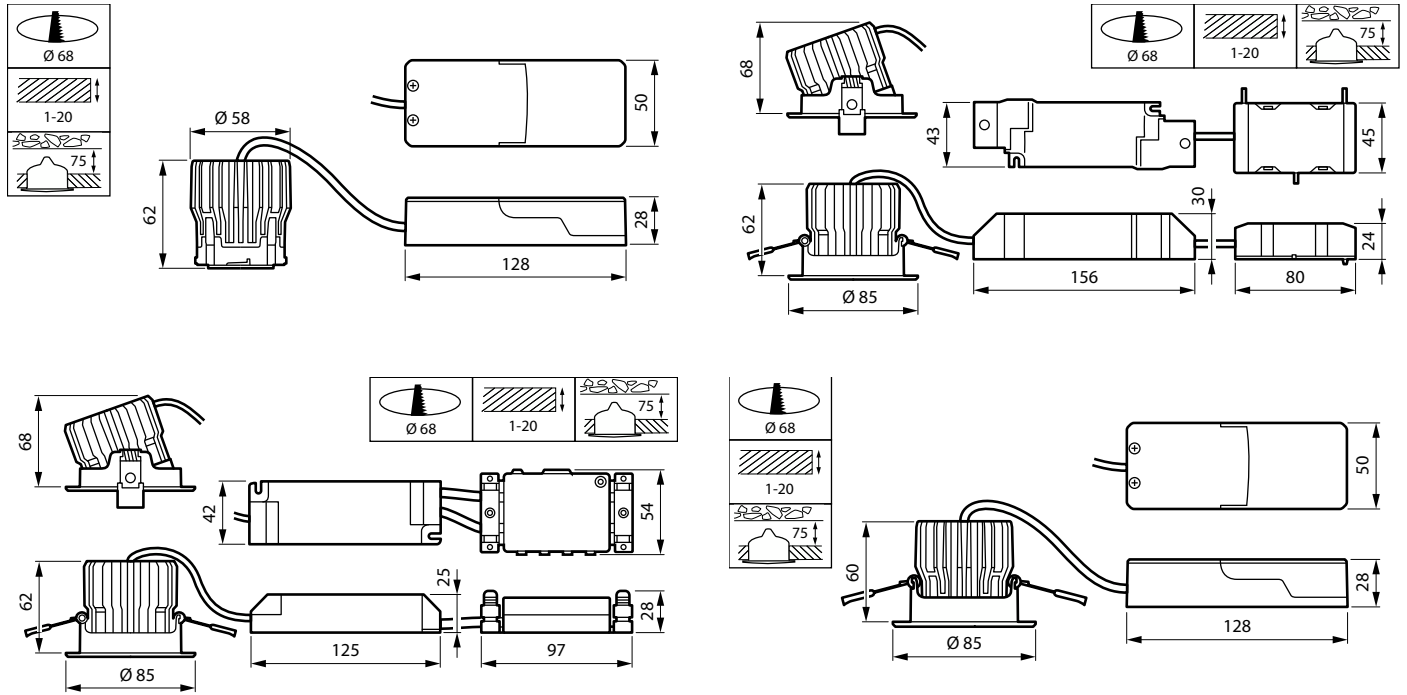

## Product details



CoreLine Recessed Spot gen2  
D68mm 650-950-1200lm  
Adjustable WH DDP



CoreLine Recessed Spot gen2  
D68mm 650-950-1200lm Fix WH  
DDP

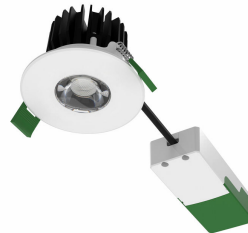

CoreLine Recessed Spot gen2  
D68mm 650-950-1200lm Fix WH  
DDP

# CoreLine Recessed Spot gen2

## Product details



CoreLine Recessed Spot gen2  
D68mm 650-950-1200lm  
Adjustable WH DDP



CoreLine Recessed Spot gen2  
D68mm 650-950-1200lm Fix ALU  
DDP

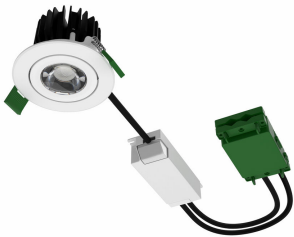

CoreLine Recessed Spot gen2  
D68mm 1200lm Adjustable PSD  
WH DDP

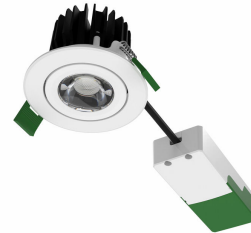

CoreLine Recessed Spot gen2  
D68mm 650-950-1200lm  
Adjustable WH DDP



CoreLine Recessed Spot gen2  
D68mm 650-950-1200lm  
Adjustable ALU DDP



CoreLine Recessed Spot gen2  
D68mm 650-950-1200lm  
Adjustable ALU DDP

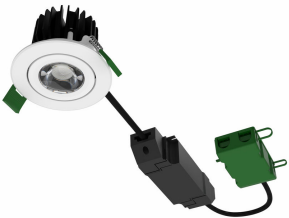

CoreLine Recessed Spot gen2  
D68mm 1200lm Adjustable WIA  
WH DDP



CoreLine Recessed Spot gen2  
D68mm 650-950-1200lm  
Adjustable ALU DDP

# CoreLine Recessed Spot gen2

## General Information

Driver included	Yes
Light source replaceable	Yes
Number of gear units	1 unit

## Light Technical

Beam angle of light source	120 degree(s)
Color rendering index (CRI)	>80
Optic type	Wide beam

## Operating and Electrical

Protection class IEC	Safety class II
Input Voltage	220 to 240 V
Line Frequency	50 or 60 Hz
Suitable for random switching	No

## Controls and Dimming

Dimmable	Yes
Maximum dim level	10% (depends on dimmer, ELV)

## Mechanical and Housing

Mech. impact protection code	IK03
------------------------------	------

## Approval and Application

Ambient temperature range	0 to +35 °C
CE mark	Yes
ENEC mark	ENEC mark
Flammability mark	For mounting on normally flammable surfaces
Glow-wire test	Temperature 650 °C, duration 30 s
Flickering value (PstLM) - Flickering value as per EN 61000-3-3	1
Stroboscopic effect visibility measure (SVM)	0.4

## Initial Performance (IEC Compliant)

Luminous flux tolerance	+/-10%
-------------------------	--------

## Light Technical

Order Code	Full Product Name	Correlated Color		
		Temperature (Nom)	Luminous Efficacy (rated) (Nom)	Luminous Flux
911401821084	RS156B LED6-WB-/830 D68HALOX PSR PI6 WH	3000 K	104 lm/W	750 lm
911401822484	RS155B LED6-WB-/830 D68 PSR PI6 ALU	3000 K	104 lm/W	750 lm
911401822784	RS155B LED9-WB-/830 D68 PSR PI6 ALU	3000 K	98 lm/W	1,000 lm
911401823084	RS155B LED12-WB-/830 D68 PSR PI6 ALU	3000 K	105 lm/W	1,300 lm
911401824684	RS155B LED6-WB-/840 D68 PSR PI6 ALU	4000 K	110 lm/W	800 lm
911401824784	RS155B LED6-WB-/827 D68 PSR PI6 ALU	2700 K	100 lm/W	720 lm
911401820584	RS156B LED6-WB-/830 D68 PSR PI6 WH	3000 K	104 lm/W	750 lm
911401820784	RS156B LED6-WB-/840 D68 PSR PI6 WH	4000 K	110 lm/W	800 lm
911401821184	RS156B LED9-WB-/830 D68 PSR PI6 WH	3000 K	98 lm/W	1,000 lm
911401821384	RS156B LED9-WB-/840 D68 PSR PI6 WH	4000 K	105 lm/W	1,080 lm
911401821584	RS156B LED12-WB-/830 D68 PSR PI6 WH	3000 K	105 lm/W	1,300 lm
911401821784	RS156B LED12-WB-/840 D68 PSR PI6 WH	4000 K	112 lm/W	1,380 lm
911401821984	RS156B LED12-WB-/830 D68 WIA PI6 WH	3000 K	108 lm/W	1,300 lm
911401822084	RS156B LED12-WB-/840 D68 WIA PI6 WH	4000 K	115 lm/W	1,380 lm
911401822184	RS156B LED12-WB-/830 D68 PSD PI10 WH	3000 K	105 lm/W	1,300 lm
911401822284	RS156B LED12-WB-/840 D68 PSD PI10 WH	4000 K	112 lm/W	1,380 lm
911401822384	RS155B LED6-WB-/830 D68 PSR PI6 WH	3000 K	104 lm/W	750 lm
911401822584	RS155B LED6-WB-/840 D68 PSR PI6 WH	4000 K	110 lm/W	800 lm
911401822684	RS155B LED9-WB-/830 D68 PSR PI6 WH	3000 K	98 lm/W	1,000 lm
911401822884	RS155B LED9-WB-/840 D68 PSR PI6 WH	4000 K	105 lm/W	1,080 lm
911401822984	RS155B LED12-WB-/830 D68 PSR PI6 WH	3000 K	105 lm/W	1,300 lm
911401823184	RS155B LED12-WB-/840 D68 PSR PI6 WH	4000 K	112 lm/W	1,380 lm
911401820684	RS156B LED6-WB-/830 D68 PSR PI6 ALU	3000 K	104 lm/W	750 lm
911401820884	RS156B LED6-WB-/840 D68 PSR PI6 ALU	4000 K	110 lm/W	800 lm

## CoreLine Recessed Spot gen2

Order Code	Full Product Name	Correlated Color		
		Temperature (Nom)	Luminous Efficacy (rated) (Nom)	Luminous Flux
911401820984	RS156B LED6-WB-/827 D68 PSR PI6 ALU	2700 K	100 lm/W	720 lm
911401821284	RS156B LED9-WB-/830 D68 PSR PI6 ALU	3000 K	98 lm/W	1,000 lm
911401821484	RS156B LED9-WB-/840 D68 PSR PI6 ALU	4000 K	105 lm/W	1,080 lm
911401821684	RS156B LED12-WB-/830 D68 PSR PI6 ALU	3000 K	105 lm/W	1,300 lm
911401821884	RS156B LED12-WB-/840 D68 PSR PI6 ALU	4000 K	112 lm/W	1,380 lm

### Operating and Electrical

Order Code	Full Product Name	Power Consumption	Order Code	Full Product Name	Power Consumption
911401821084	RS156B LED6-WB-/830 D68HALOX PSR PI6 WH	7.2 W	911401822284	RS156B LED12-WB-/840 D68 PSD PI10 WH	12.3 W
911401822484	RS155B LED6-WB-/830 D68 PSR PI6 ALU	7.2 W	911401822384	RS155B LED6-WB-/830 D68 PSR PI6 WH	7.2 W
911401822784	RS155B LED9-WB-/830 D68 PSR PI6 ALU	10.2 W	911401822584	RS155B LED6-WB-/840 D68 PSR PI6 WH	7.2 W
911401823084	RS155B LED12-WB-/830 D68 PSR PI6 ALU	12.3 W	911401822684	RS155B LED9-WB-/830 D68 PSR PI6 WH	10.2 W
911401824684	RS155B LED6-WB-/840 D68 PSR PI6 ALU	7.2 W	911401822884	RS155B LED9-WB-/840 D68 PSR PI6 WH	10.2 W
911401824784	RS155B LED6-WB-/827 D68 PSR PI6 ALU	7.2 W	911401822984	RS155B LED12-WB-/830 D68 PSR PI6 WH	12.3 W
911401820584	RS156B LED6-WB-/830 D68 PSR PI6 WH	7.2 W	911401823184	RS155B LED12-WB-/840 D68 PSR PI6 WH	12.3 W
911401820784	RS156B LED6-WB-/840 D68 PSR PI6 WH	7.2 W	911401820684	RS156B LED6-WB-/830 D68 PSR PI6 ALU	7.2 W
911401821184	RS156B LED9-WB-/830 D68 PSR PI6 WH	10.2 W	911401820884	RS156B LED6-WB-/840 D68 PSR PI6 ALU	7.2 W
911401821384	RS156B LED9-WB-/840 D68 PSR PI6 WH	10.2 W	911401820984	RS156B LED6-WB-/827 D68 PSR PI6 ALU	7.2 W
911401821584	RS156B LED12-WB-/830 D68 PSR PI6 WH	12.3 W	911401821284	RS156B LED9-WB-/830 D68 PSR PI6 ALU	10.2 W
911401821784	RS156B LED12-WB-/840 D68 PSR PI6 WH	12.3 W	911401821484	RS156B LED9-WB-/840 D68 PSR PI6 ALU	10.2 W
911401821984	RS156B LED12-WB-/830 D68 WIA PI6 WH	12 W	911401821684	RS156B LED12-WB-/830 D68 PSR PI6 ALU	12.3 W
911401822084	RS156B LED12-WB-/840 D68 WIA PI6 WH	12 W	911401821884	RS156B LED12-WB-/840 D68 PSR PI6 ALU	12.3 W
911401822184	RS156B LED12-WB-/830 D68 PSD PI10 WH	12.3 W			

### Mechanical and Housing

Order Code	Full Product Name	Housing Color	Ingress protection code	Order Code	Full Product Name	Housing Color	Ingress protection code
911401821084	RS156B LED6-WB-/830 D68HALOX PSR PI6 WH	White	IP20/44	911401820784	RS156B LED6-WB-/840 D68 PSR PI6 WH	White	IP20/44
911401822484	RS155B LED6-WB-/830 D68 PSR PI6 ALU	Aluminum	IP20/65	911401821184	RS156B LED9-WB-/830 D68 PSR PI6 WH	White	IP20/44
911401822784	RS155B LED9-WB-/830 D68 PSR PI6 ALU	Aluminum	IP20/65	911401821384	RS156B LED9-WB-/840 D68 PSR PI6 WH	White	IP20/44
911401823084	RS155B LED12-WB-/830 D68 PSR PI6 ALU	Aluminum	IP20/65	911401821584	RS156B LED12-WB-/830 D68 PSR PI6 WH	White	IP20/44
911401824684	RS155B LED6-WB-/840 D68 PSR PI6 ALU	Aluminum	IP20/65	911401821784	RS156B LED12-WB-/840 D68 PSR PI6 WH	White	IP20/44
911401824784	RS155B LED6-WB-/827 D68 PSR PI6 ALU	Aluminum	IP20/65	911401821984	RS156B LED12-WB-/830 D68 WIA PI6 WH	White	IP20/44
911401820584	RS156B LED6-WB-/830 D68 PSR PI6 WH	White	IP20/44	911401822084	RS156B LED12-WB-/840 D68 WIA PI6 WH	White	IP20/44

# CoreLine Recessed Spot gen2

Order Code	Full Product Name	Housing Color	Ingress protection code
911401822184	RS156B LED12-WB-/830 D68 PSD PI10 WH	White	IP20/44
911401822284	RS156B LED12-WB-/840 D68 PSD PI10 WH	White	IP20/44
911401822384	RS155B LED6-WB-/830 D68 PSR PI6 WH	White	IP20/65
911401822584	RS155B LED6-WB-/840 D68 PSR PI6 WH	White	IP20/65
911401822684	RS155B LED9-WB-/830 D68 PSR PI6 WH	White	IP20/65
911401822884	RS155B LED9-WB-/840 D68 PSR PI6 WH	White	IP20/65
911401822984	RS155B LED12-WB-/830 D68 PSR PI6 WH	White	IP20/65
911401822984	RS155B LED12-WB-/840 D68 PSR PI6 WH	White	IP20/65
911401823184	RS155B LED12-WB-/830 D68 PSR PI6 WH	White	IP20/65
911401823184	RS155B LED12-WB-/840 D68 PSR PI6 WH	White	IP20/65

Order Code	Full Product Name	Housing Color	Ingress protection code
911401820684	RS156B LED6-WB-/830 D68 PSR PI6 ALU	Aluminum	IP20/44
911401820884	RS156B LED6-WB-/840 D68 PSR PI6 ALU	Aluminum	IP20/44
911401820984	RS156B LED6-WB-/827 D68 PSR PI6 ALU	Aluminum	IP20/44
911401821284	RS156B LED9-WB-/830 D68 PSR PI6 ALU	Aluminum	IP20/44
911401821484	RS156B LED9-WB-/840 D68 PSR PI6 ALU	Aluminum	IP20/44
911401821684	RS156B LED12-WB-/830 D68 PSR PI6 ALU	Aluminum	IP20/44
911401821884	RS156B LED12-WB-/840 D68 PSR PI6 ALU	Aluminum	IP20/44

## Initial Performance (IEC Compliant)

Order Code	Full Product Name	Initial chromaticity
911401821084	RS156B LED6-WB-/830 D68HALOX PSR PI6 WH	(0.43, 0.40) SDCM <5
911401822484	RS155B LED6-WB-/830 D68 PSR PI6 ALU	(0.43, 0.40) SDCM <5
911401822784	RS155B LED9-WB-/830 D68 PSR PI6 ALU	(0.43, 0.40) SDCM <5
911401823084	RS155B LED12-WB-/830 D68 PSR PI6 ALU	(0.43, 0.40) SDCM <5
911401824684	RS155B LED6-WB-/840 D68 PSR PI6 ALU	(0.38, 0.38) SDCM <5
911401824784	RS155B LED6-WB-/827 D68 PSR PI6 ALU	(0.46, 0.41) SDCM <5
911401820584	RS156B LED6-WB-/830 D68 PSR PI6 WH	(0.43, 0.40) SDCM <5
911401820784	RS156B LED6-WB-/840 D68 PSR PI6 WH	(0.38, 0.38) SDCM <5
911401821184	RS156B LED9-WB-/830 D68 PSR PI6 WH	(0.43, 0.40) SDCM <5
911401821384	RS156B LED9-WB-/840 D68 PSR PI6 WH	(0.38, 0.38) SDCM <5
911401821584	RS156B LED12-WB-/830 D68 PSR PI6 WH	(0.43, 0.40) SDCM <5
911401821784	RS156B LED12-WB-/840 D68 PSR PI6 WH	(0.38, 0.38) SDCM <5
911401821984	RS156B LED12-WB-/830 D68 WIA PI6 WH	(0.43, 0.40) SDCM <5
911401822084	RS156B LED12-WB-/840 D68 WIA PI6 WH	(0.38, 0.38) SDCM <5
911401822184	RS156B LED12-WB-/830 D68 PSD PI10 WH	(0.43, 0.40) SDCM <5

Order Code	Full Product Name	Initial chromaticity
911401822284	RS156B LED12-WB-/840 D68 PSD PI10 WH	(0.38, 0.38) SDCM <5
911401822384	RS155B LED6-WB-/830 D68 PSR PI6 WH	(0.43, 0.40) SDCM <5
911401822584	RS155B LED6-WB-/840 D68 PSR PI6 WH	(0.38, 0.38) SDCM <5
911401822684	RS155B LED9-WB-/830 D68 PSR PI6 WH	(0.43, 0.40) SDCM <5
911401822884	RS155B LED9-WB-/840 D68 PSR PI6 WH	(0.38, 0.38) SDCM <5
911401822984	RS155B LED12-WB-/830 D68 PSR PI6 WH	(0.43, 0.40) SDCM <5
911401823184	RS155B LED12-WB-/840 D68 PSR PI6 WH	(0.38, 0.38) SDCM <5
911401820684	RS156B LED6-WB-/830 D68 PSR PI6 ALU	(0.43, 0.40) SDCM <5
911401820884	RS156B LED6-WB-/840 D68 PSR PI6 ALU	(0.38, 0.38) SDCM <5
911401820984	RS156B LED6-WB-/827 D68 PSR PI6 ALU	(0.46, 0.41) SDCM <5
911401821284	RS156B LED9-WB-/830 D68 PSR PI6 ALU	(0.43, 0.40) SDCM <5
911401821484	RS156B LED9-WB-/840 D68 PSR PI6 ALU	(0.38, 0.38) SDCM <5
911401821684	RS156B LED12-WB-/830 D68 PSR PI6 ALU	(0.43, 0.40) SDCM <5
911401821884	RS156B LED12-WB-/840 D68 PSR PI6 ALU	(0.38, 0.38) SDCM <5

## Polar Wide Diagrams

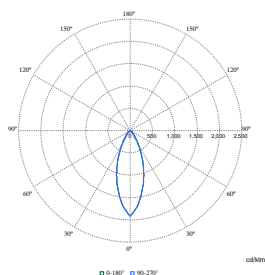

Polar Normal (separate) - 911401824684

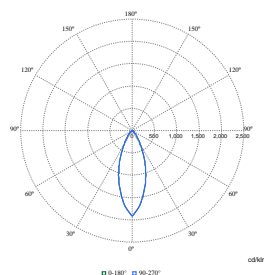

Polar Normal (separate) - 911401824784

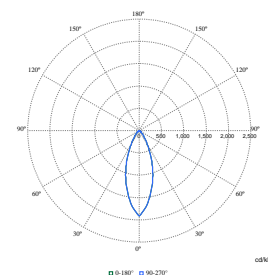

Polar Normal (separate) - 911401820584





# CoreLine Recessed Spot gen2

## Polar Wide Diagrams

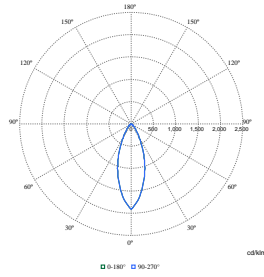
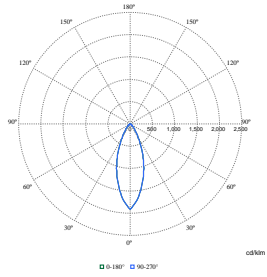

Polar Normal (separate) - 911401823084

Polar Normal (separate) - 911401823184

