



DALI Square Track – flexibility enabling energy savings

DALI Square Track

Designed for use with DALI projectors with a dedicated adaptor, the DALI Square Track is ideal for users who want lighting flexibility to create a specific ambience in their shop and to reduce energy consumption. The system is made up of a solid aluminium track, which is available in various lengths and with a choice of electrical conductors. Any given configuration can be easily created – horizontal or vertical, mounted on or in the ceiling, on the wall or on free-standing panels. The system can also be used as a floating structure. All luminaires have a separate power supply and can be switched selectively. They can easily be moved to alter the lighting and presentation. In this way, a multifunctional track system can be created for accent lighting as well as for suspending advertising and decorative material.

Benefits

- Allows flexible light settings
- Enables energy savings
- Unobtrusive smart track

Features

- Integration of the DALI protocol within an unobtrusive retail spot track widely used for dimming and control
- Can be used with all Philips LED 3C track spots
- Available in lengths of 1, 2, 3 and 4 m
- Seven electrical conductors: L1/L2/L3/neutral/ground 16A/400V, IP20 + DA/DA 2x1A/50V FELV AC (DALI)
- Available in three finishes – white, black, aluminium
- Range of adaptors, power supply connections and mounting accessories available

DALI Square Track

Application

- Accent lighting in retail outlets, shopping malls, museums
- All indoor architectural lighting applications

Versions



RBS750 recessed track, white

Dimensional drawing

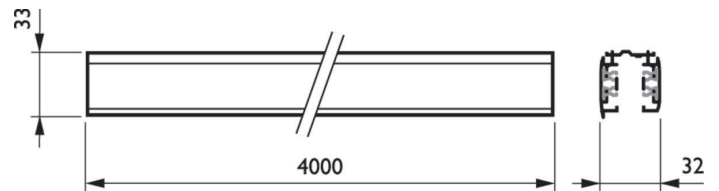
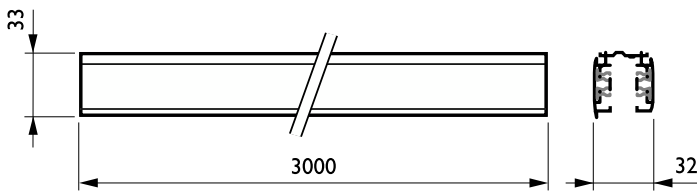
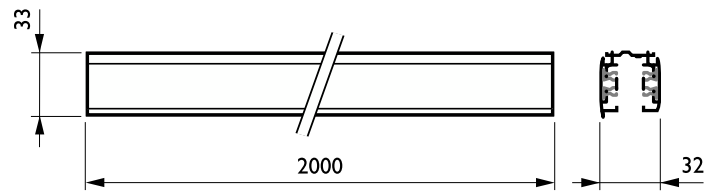
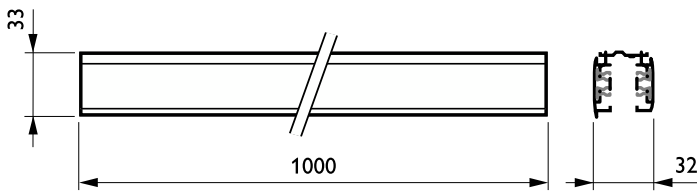

DALI Square Track

Dimensional drawing

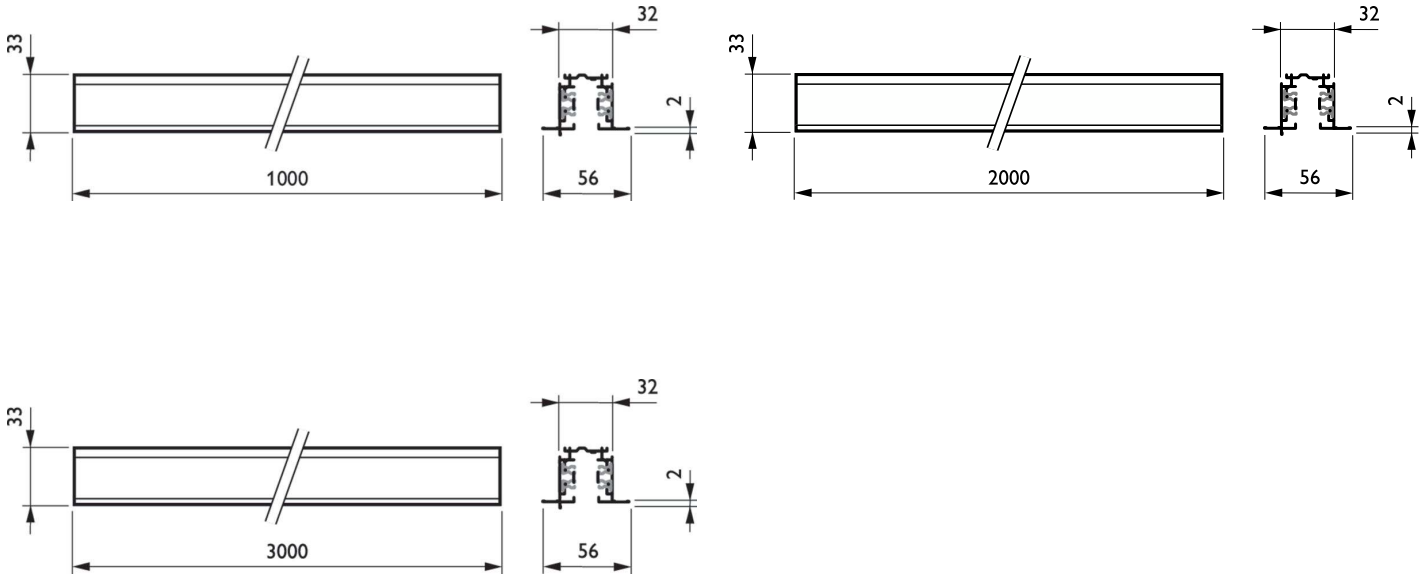

Product details

IPDP_RCS750i_0001-Detail photo

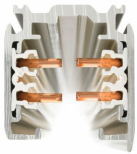

IPDP_RCS750i_0003-Detail photo

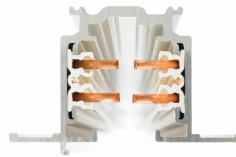

DALI Square Track

Operating and Electrical

Protection class IEC	Safety class I
----------------------	----------------

Protection class IEC	Safety class I
----------------------	----------------

Mechanical and Housing

Ingress protection code	IP30
-------------------------	------

Ingress protection code	IP30
-------------------------	------

Approval and Application

CE mark	Yes
---------	-----

CE mark	Yes
---------	-----

Glow-wire test	Temperature 850 °C, duration 5 s
----------------	-------------------------------------

Glow-wire test	Temperature 850 °C, duration 5 s
----------------	-------------------------------------

Mechanical and Housing

Order Code	Full Product Name	Accessory colour
910502500058	RBS750 5C6 L3000 WH (XTSCF6300-3)	White
910502500061	RBS750 5C6 L2000 WH (XTSCF6200-3)	White
910502500043	RCS750 5C6 L4000 WH (XTSC6400-3)	White
910502500046	RCS750 5C6 L3000 WH (XTSC6300-3)	White
910502500049	RCS750 5C6 L2000 WH (XTSC6200-3)	White
910502500052	RCS750 5C6 L1000 WH (XTSC6100-3)	White
910502500041	RCS750 5C6 L4000 ALU (XTSC6400-1)	Aluminium
910502500044	RCS750 5C6 L3000 ALU (XTSC6300-1)	Aluminium
910502500047	RCS750 5C6 L2000 ALU (XTSC6200-1)	Aluminium
910502500050	RCS750 5C6 L1000 ALU (XTSC6100-1)	Aluminium
910502500057	RBS750 5C6 L3000 BK (XTSCF6300-2)	Black
910502500060	RBS750 5C6 L2000 BK (XTSCF6200-2)	Black
910502500063	RBS750 5C6 L1000 BK (XTSCF6100-2)	Black
910502500056	RBS750 5C6 L3000 ALU (XTSCF6300-1)	Aluminium
910502500059	RBS750 5C6 L2000 ALU (XTSCF6200-1)	Aluminium
910502500062	RBS750 5C6 L1000 ALU (XTSCF6100-1)	Aluminium
910502500042	RCS750 5C6 L4000 BK (XTSC6400-2)	Black
910502500045	RCS750 5C6 L3000 BK (XTSC6300-2)	Black
910502500048	RCS750 5C6 L2000 BK (XTSC6200-2)	Black
910502500051	RCS750 5C6 L1000 BK (XTSC6100-2)	Black

