



# TrueBlend: Proposition build around flexibility, choice, and performance.

## TrueBlend Recessed

When specifying lighting for premium office applications, technical specifiers need to deal with a wide variety of requirements and constraints linked to ceiling types and customer/architect preferences. Philips TrueBlend is a flexible luminaire portfolio offering choice in look & feel for the architect, and mechanical fit to many different ceiling types, and a palette of optics to choose from. Philips TrueBlend is built around flexibility and choice; our new recessed office range is a perfect fit for your non-standard ceiling or renovation project where luminaires need to fit the hole of existing luminaires. A wide variety of optics, best-in-class efficacy, combined with our wellbeing led spectra, and Interact connectivity, offers choice in performance and look & feel. TrueBlend helps save energy & provide the right level of light. Not only is it compliant with the WELL Building Standard for Light, but also is rated UGR<19, which is compliant with all office norms (OC). This luminaire family is available in different lengths, light outputs, optics, housing colors, various bracket height, connectors. This offers the ultimate design flexibility and unlimited possibilities. TrueBlend luminaires offer state-of-the-art efficacy and excellent light quality (CRI>90) with upgradability features and repairability that promises a long lifetime. They are also designed for recyclability, making them a truly circular, green choice. So, TrueBlend is an all-in-one solution with superior lighting specifications combined with sustainable approach to high-performance office lighting.

# TrueBlend Recessed

## Benefits

- Designed for enhanced well-being of people with high quality of light.
- Best-in-class efficacy with superior lighting specifications & long lifetime
- Sustainable, future-ready, scalable smart office capabilities with best-in-class Interact proposition.
- Significantly reduces operational costs for an attractive payback time.

## Features

- Best-in-class efficacy up to 170lm/W supports green building design and energy saving subsidy criteria.
- Office-compliant lighting with wide optics choices like DLO, MLO & mini cups.
- Highly uniform lighting with excellent glare control (UGR<19, L65<3000cd/m2)
- 3000K, 4000K, Tunable White & tunable white bio-up versions, all CRI>90
- Long lifetime upto L90@50,000 hours
- Wide connector choice for simpler & faster installation
- Connected system ready with Interact Pro scalable platform using integrated sensors and/or wireless drivers for data collection, occupancy, daylight regulation and wayfinding.
- Prepared for circularity (no glue, replaceable electronics, upgradable system, efficient and long lifetime) plus supporting Environmental Product Declaration (EPD) guide.
- Recessed mounting options, including all accessories.

## Application

- Offices
- Education
- Retail

## Warnings and Safety

- The product is IP20 and, as such, is not protected against water ingress. Therefore, we strongly recommend that the environment in which the luminaire is to be installed is suitably checked.
- If the above advice is not taken and the luminaires are subject to water ingress, Philips / Signify cannot guarantee safe failure and the product warranty will become void.

## Versions



TrueBlend MLO/MXO SPP



TrueBlend Recessed RC453B DLO U4 EL



TrueBlend Recessed RC455B MXO

# TrueBlend Recessed

## Versions



TrueBlend Recessed RC455B  
minicups WH U4 4FT



TrueBlend Recessed RC455B DLO  
U4



TrueBlend Recessed RC455B DLO  
4Ft



TrueBlend Recessed RC455B DLO  
U4



TrueBlend Recessed RC455B MCB  
U4



TrueBlend Recessed RC455B MLO  
U4 4FT



TrueBlend Recessed RC455B DLO



TrueBlend Recessed RC453B DLO  
U4



TrueBlend Recessed RC453B MXO



TrueBlend Recessed RC455B MINI  
CUPS WH U4



TrueBlend Recessed RC453B DLO  
U5

# TrueBlend Recessed

## Dimensional drawing

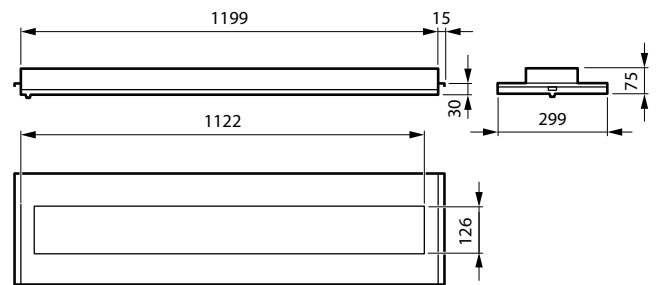
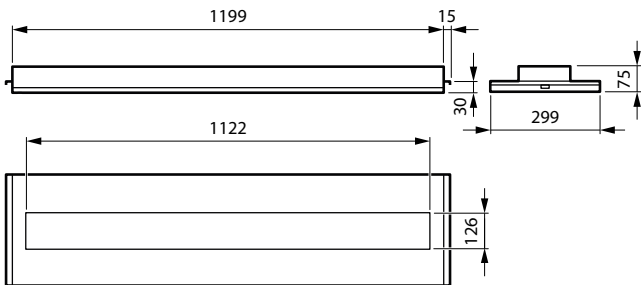
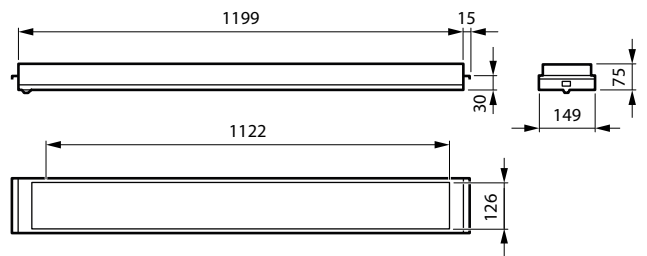
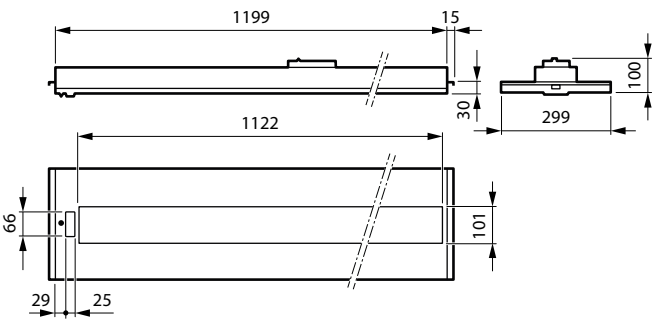
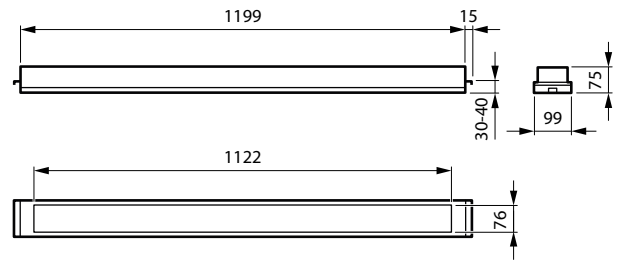
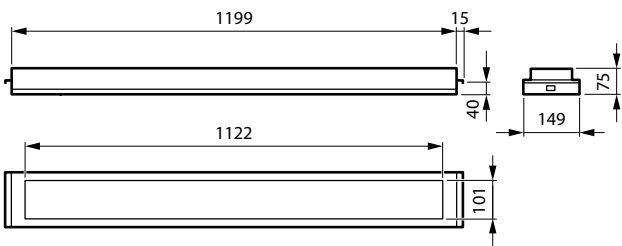
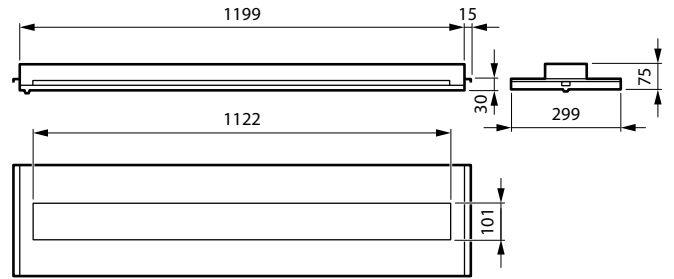
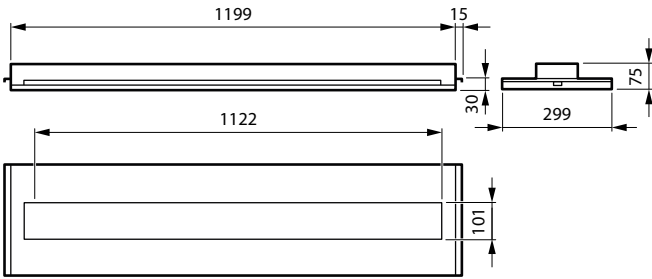

# TrueBlend Recessed

## Dimensional drawing

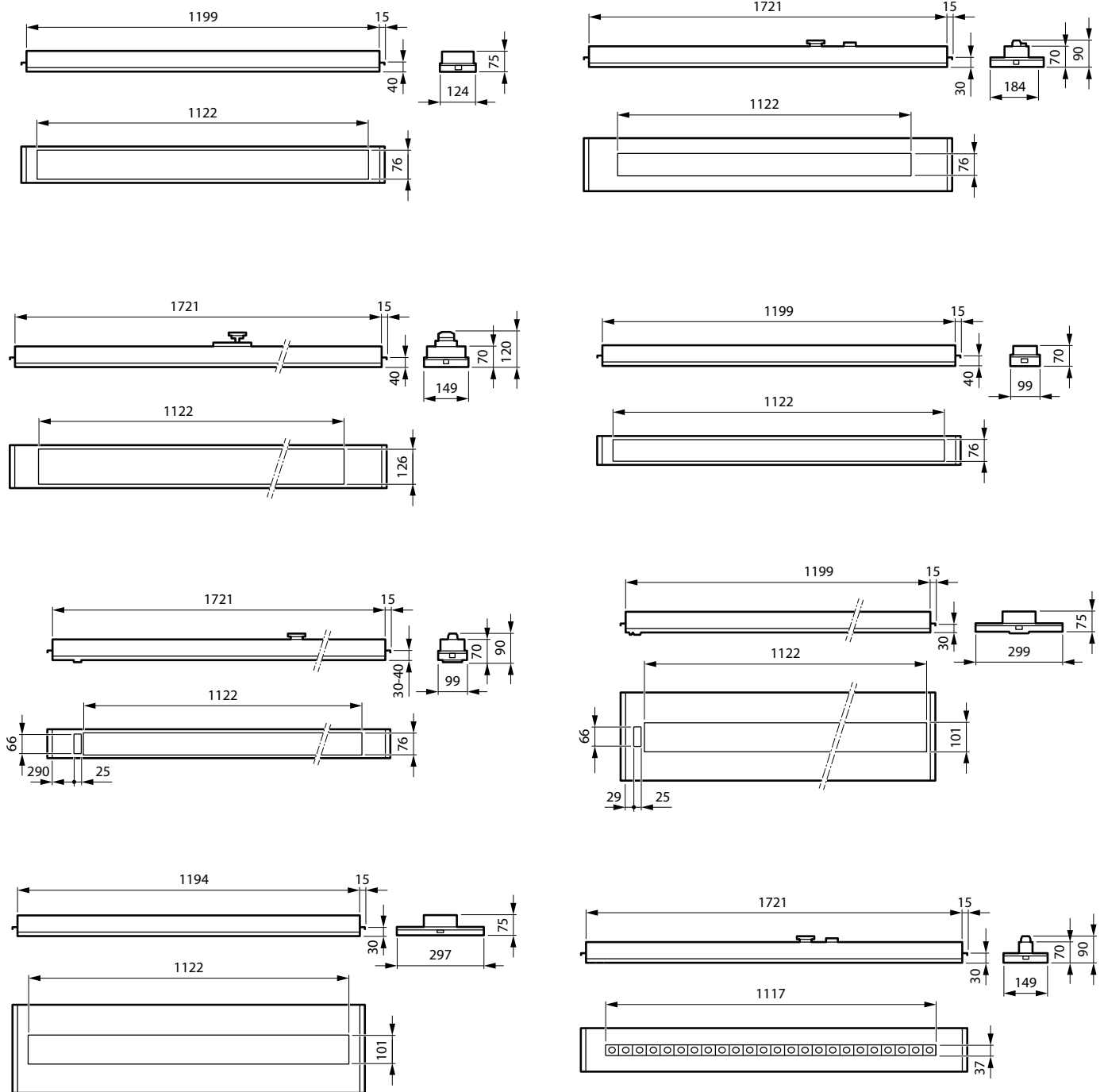

# TrueBlend Recessed

## Dimensional drawing

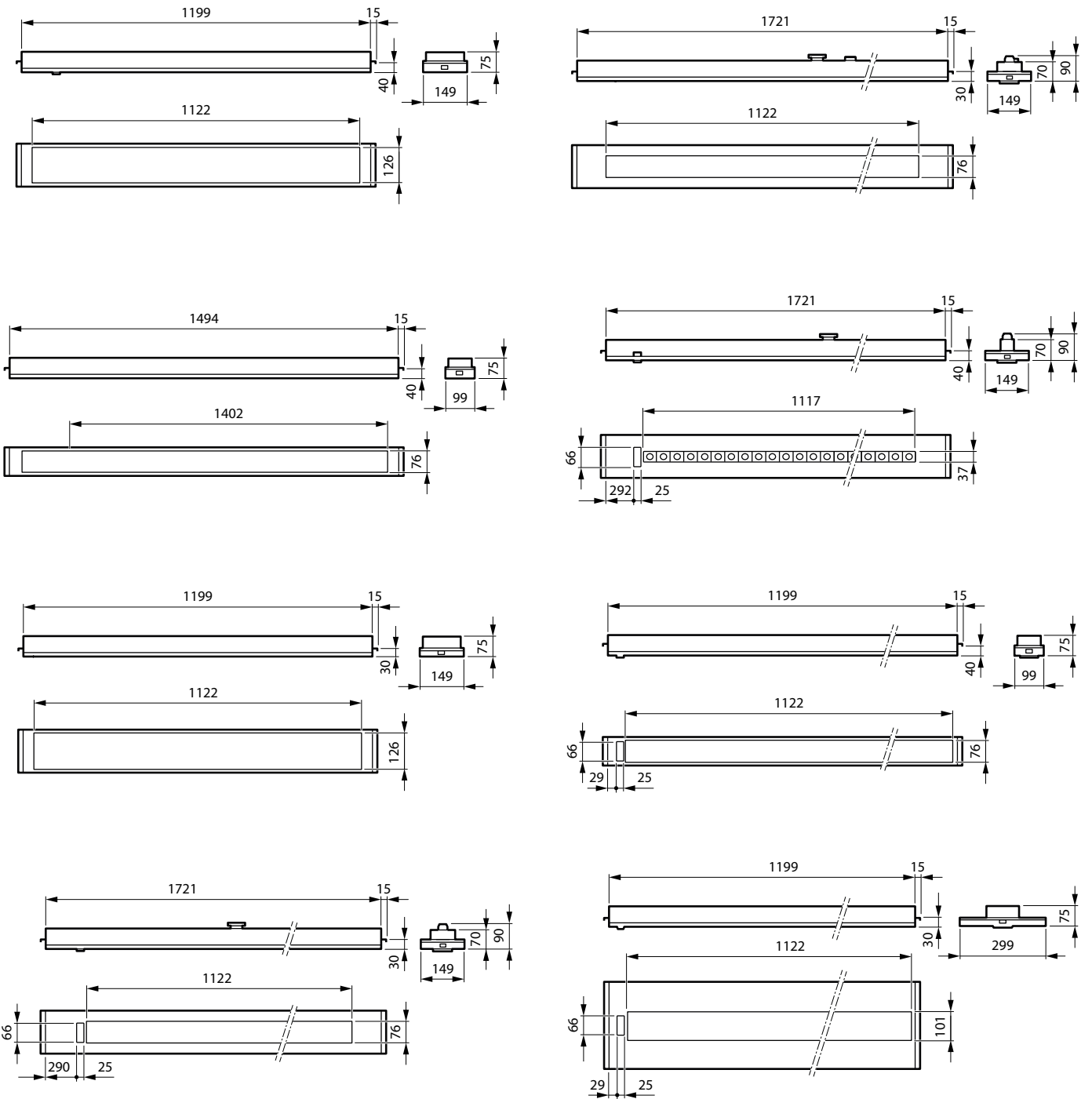

# TrueBlend Recessed

## Dimensional drawing

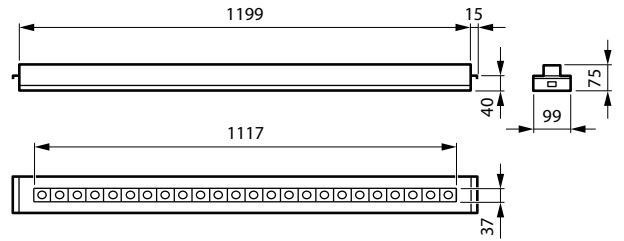
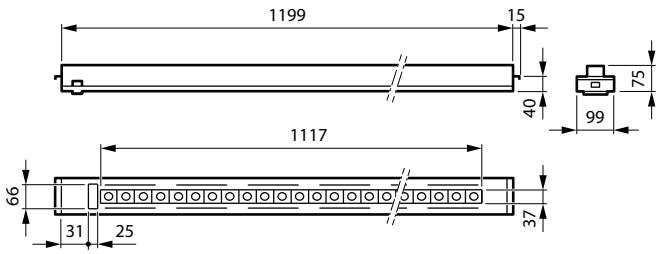

## Product details



TrueBlend Recessed DLO- optics  
DPP



TrueBlend Recessed U5 sensor



TrueBlend Recessed MXO- optics  
DPP



TrueBlend Recessed Mini cups-  
Black optics DPP



TrueBlend Recessed U4 sensor



TrueBlend Recessed U4 & EL  
indicator DPP



TrueBlend Recessed Mini cups-  
White optics DPP



TrueBlend Recessed EL indicator

# TrueBlend Recessed

General Information	
Driver included	Yes
Number of gear units	1 unit
Service tag	Yes
Light Technical	
Upward light output ratio	0
Operating and Electrical	
Protection class IEC	Safety class I
Input Voltage	220 to 240 V
Line Frequency	50 to 60 Hz
Controls and Dimming	
Dimmable	Yes
Maximum dim level	1%
Mechanical and Housing	
Housing Color	White
Mech. impact protection code	IK03
Ingress protection code	IP20
Emergency Operation	
Central Emergency	Yes
Approval and Application	
Ambient temperature range	+10 to +35 °C
CE mark	Yes
ENEC mark	ENEC mark
Flammability mark	For mounting on normally flammable surfaces
Glow-wire test	Temperature 850 °C, duration 30 s
Initial Performance (IEC Compliant)	
Luminous flux tolerance	+/-10%
Product Data	
Product family code	RC455B

## General Information

Order Code	Full Product Name	Lamp family code
910505103952	RC455B 36S/940 MXO U4 L1200 W100 B40	36S
910505103958	RC455B 40S/TW9 MXO U4 L1200 W100 B40	40S
910505103960	RC455B 40S/940 MXO ELP3 W6L1722W150B40WT	40S
910505103949	RC455B 28S/TW9 MLO U4 L1720 W124 B40	40S
910505103950	RC455B 36S/940 MLO U4 W3 L1722 W100 B40	36S
910505103974	RC453B42S/940DLO9010U4ELW3W4L1200W300B30	42S
910505103976	RC453B 36S/940 DLO9010U4ELW3L1200W300B30	34S
910505103957	RC455B 48S/940 MXO L1495 W100 B40	48S
910505103959	RC455B 28S/TWBU MCW-M U4 L1200 W100 B40	40S
910505103965	RC455B 36S/940 MCW-M U4 L1200 W100 B40	36S
910505103978	RC453B 28S/UE840 MXO 9010 L1200 W300 B30	28S
910505103979	RC453B 28S/UE840MXO9010ELP3 L1200W300B30	28S
910505103951	RC455B 36S/940 MXO L1200 W100 B40	36S
910505103953	RC455B 40S/940 MXO L1200 W100 B40	40S
910505103954	RC455B 36S/940 MXO L1200 W125 B40	36S
910505103955	RC455B 36S/940 MXO L1200 W150 B40	36S
910505103956	RC455B 28S/940 MXO L1200 W150 B40	28S
910505103937	RC455B 40S/940 DLO U4 W3 L1722 W100 B30	40S
910505103940	RC455B 36S/940 DLO L1200 W100 B30	36S
910505103936	RC455B 36S/940 DLO 9010U4W3 L1722W150B30	36S
910505103967	RC455B 40S/940 MCB-M W3W2 L1722 W150 B30	40S
910505103948	RC455B 28S/TW9 MLO U4 L1200 W100 B40	36S
910505103962	RC455B 36S/940 MCB-M L1200 W100 B40	36S
910505103964	RC455B 40S/940 MCB-M L1200 W100 B40	40S
910505103966	RC455B 36S/940 MCB-M U4 L1200 W100 B40	36S
910505103938	RC455B 40S/940 DLO W3W2 L1722 W150 B30	40S
910505103939	RC455B 36S/940 DLO W3W2 L1722 W185 B30	36S
910505103973	RC453B 42S/940 DLO 9010 U4 L1200 W300B30	42S
910505103981	RC453B 40S/TW9 DLO U4 L1200 W300 B30	28S
910505103980	RC453B 28S/UE840 MXO9010ELP3L1200W150B30	28S
910505103982	RC453B 28S/UE840 MXO L1200 W150 B30	28S
910505103941	RC455B 28S/940 MLO L1200 W100 B40	28S
910505103942	RC455B 36S/940 MLO L1200 W100 B40	36S
910505103943	RC455B 36S/940 MLO L1200 W125 B40	36S
910505103944	RC455B 36S/940 MLO L1200 W150 B40	36S
910505103945	RC455B 40S/940 MLO L1200 W100 B40	40S
910505103946	RC455B 48S/940 MLO L1495 W100 B40	48S
910505103947	RC455B 28S/TW9 MLO L1200 W100 B40	40S
910505103971	RC453B 28S/840 DLO L1200 W300 B30	28S
910505103972	RC453B 28S/840 DLO 9010 ELP3L1200W300B30	28S
910505103977	RC453B 28S/840 DLO L1195 W298 B30	28S
910505103961	RC455B 36S/940 MCW-M L1200 W100 B40	36S
910505103963	RC455B 40S/940 MCW-M L1200 W100 B40	40S
910505103968	RC455B 40S/940MCW-M U4W3 L1722 W150 B40	40S
910505103975	RC453B 36S/940 DLO U5 L1200 W300 B30	34S

## Light Technical (1/2)

# TrueBlend Recessed

Order Code	Full Product Name	Correlated Color Temperature (Nom)	Color rendering index (CRI)	Lumino Efficacy (rated) (Nom)	Order Code	Full Product Name	Correlated Color Temperature (Nom)	Color rendering index (CRI)	Luminous Efficacy (rated) (Nom)
910505103952	RC455B 36S/940 MXO U4 L1200 W100 B40	4000 K	>90	122 lm/W	910505103952	RC455B 36S/940 MXO U4 L1200 W100 B40	2700-6500 K		
910505103958	RC455B 40S/TW9 MXO U4 L1200 W100 B40	Tunable white 2700-6500 K	>90	90 lm/W	910505103962	RC455B 36S/940 MCB-M L1200 W100 B40	4000 K	>90	105 lm/W
					910505103964	RC455B 40S/940 MCB-M L1200 W100 B40	4000 K	>90	104 lm/W
910505103960	RC455B 40S/940 MXO ELP3 W6L1722W150B40WT	4000 K	>90	108 lm/W	910505103966	RC455B 36S/940 MCB-M U4 L1200 W100 B40	4000 K	>90	107 lm/W
910505103949	RC455B 28S/TW9 MLO U4 L1720 W124 B40	Tunable white 2700-6500 K	>90	85 lm/W	910505103938	RC455B 40S/940 DLO W3W2 L1722 W150 B30	4000 K	>90	151 lm/W
					910505103939	RC455B 36S/940 DLO W3W2 L1722 W185 B30	4000 K	>90	150 lm/W
910505103950	RC455B 36S/940 MLO U4 W3 L1722 W100 B40	4000 K	>90	95 lm/W	910505103973	RC453B 42S/940 DLO 9010 U4 L1200 W300B30	4000 K	>90	162 lm/W
910505103974	RC453B42S/940DLO9010U4ELW3W4L1200W300B30	4000 K	>90	131 lm/W	910505103981	RC453B 40S/TW9 DLO U4 L1200 W300 B30	Tunable white 2700-6500 K	>90	118 lm/W
910505103976	RC453B 36S/940 DLO9010U4ELW3L1200W300B30	4000 K	>90	126 lm/W	910505103980	RC453B 28S/UE840 MXO9010ELP3L1200W150B30	4000 K	>80	110 lm/W
910505103957	RC455B 48S/940 MXO L1495 W100 B40	4000 K	>90	119 lm/W	910505103982	RC453B 28S/UE840 MXO L1200 W150 B30	4000 K	>80	144 lm/W
910505103959	RC455B 28S/TWBU MCW-M U4 L1200 W100 B40	Tunable white 2700-6500 K	>90	75 lm/W	910505103941	RC455B 28S/940 MLO L1200 W100 B40	4000 K	>90	97 lm/W
					910505103942	RC455B 36S/940 MLO L1200 W100 B40	4000 K	>90	95 lm/W
910505103965	RC455B 36S/940 MCW-M U4 L1200 W100 B40	4000 K	>90	122 lm/W	910505103943	RC455B 36S/940 MLO L1200 W125 B40	4000 K	>90	100 lm/W
910505103978	RC453B 28S/UE840 MXO 9010 L1200 W300 B30	4000 K	>80	144 lm/W	910505103944	RC455B 36S/940 MLO L1200 W150 B40	4000 K	>90	100 lm/W
					910505103945	RC455B 40S/940 MLO L1200 W100 B40	4000 K	>90	94 lm/W
910505103979	RC453B 28S/UE840MXO9010ELP3 L1200W300B30	4000 K	>80	110 lm/W	910505103946	RC455B 48S/940 MLO L1495 W100 B40	4000 K	>90	96 lm/W
					910505103947	RC455B 28S/TW9 MLO L1200 W100 B40	Tunable white 2700-6500 K	>90	85 lm/W
910505103951	RC455B 36S/940 MXO L1200 W100 B40	4000 K	>90	120 lm/W	910505103948	RC455B 36S/940 MLO L1200 W150 B40	4000 K	>90	127 lm/W
910505103953	RC455B 40S/940 MXO L1200 W100 B40	4000 K	>90	118 lm/W	910505103971	RC453B 28S/840 DLO L1200 W300 B30	4000 K	>80	161 lm/W
910505103954	RC455B 36S/940 MXO L1200 W125 B40	4000 K	>90	124 lm/W	910505103972	RC453B 28S/840 DLO 9010 ELP3L1200W300B30	4000 K	>80	119 lm/W
910505103955	RC455B 36S/940 MXO L1200 W150 B40	4000 K	>90	129 lm/W	910505103977	RC453B 28S/840 DLO L1195 W298 B30	4000 K	>80	124 lm/W
910505103956	RC455B 28S/940 MXO L1200 W150 B40	4000 K	>90	127 lm/W	910505103961	RC455B 36S/940 MCW-M L1200 W100 B40	4000 K	>90	120 lm/W
910505103937	RC455B 40S/940 DLO U4 W3 L1722 W100 B30	4000 K	>90	154 lm/W	910505103963	RC455B 40S/940 MCW-M L1200 W100 B40	4000 K	>90	119 lm/W
					910505103968	RC455B 40S/940MCW-M U4W3 L1722 W150 B30	4000 K	>90	121 lm/W
910505103940	RC455B 36S/940 DLO L1200 W100 B30	4000 K	>90	150 lm/W	910505103975	RC455B 40S/940 MCW-M L1200 W100 B40	4000 K	>90	119 lm/W
910505103936	RC455B 36S/940 DLO 9010U4W3 L1722W150B30	4000 K	>90	153 lm/W	910505103976	RC455B 40S/940 MCW-M L1200 W100 B40	4000 K	>90	119 lm/W
910505103967	RC455B 40S/940 MCB-M W3W2 L1722 W150 B30	4000 K	>90	105 lm/W	910505103978	RC455B 40S/940MCW-M U4W3 L1722 W150 B40	4000 K	>90	121 lm/W
910505103948	RC455B 28S/TW9 MLO U4 L1200 W100 B40	Tunable white	>90	85 lm/W	910505103975	RC453B 36S/940 DLO U5 L1200 W300 B30	4000 K	>90	160 lm/W

## Light Technical (2/2)

Order Code	Full Product Name	Optic type	Order Code	Full Product Name	Optic type
910505103952	RC455B 36S/940 MXO U4 L1200 W100 B40	Wide beam	910505103958	RC455B 40S/TW9 MXO U4 L1200 W100 B40	Wide beam

## TrueBlend Recessed

Order Code	Full Product Name	Optic type
910505103960	RC455B 40S/940 MXO ELP3 W6L1722W150B40WT	Wide beam
910505103949	RC455B 28S/TW9 MLO U4 L1720 W124 B40	Wide beam office compliant
910505103950	RC455B 36S/940 MLO U4 W3 L1722 W100 B40	Wide beam office compliant
910505103974	RC453B42S/940DLO9010U4ELW3W4L1200W300B30	Wide beam office compliant
910505103976	RC453B 36S/940 DLO9010U4ELW3L1200W300B30	Wide beam office compliant
910505103957	RC455B 48S/940 MXO L1495 W100 B40	Wide beam
910505103959	RC455B 28S/TWBU MCW-M U4 L1200 W100 B40	Reflector
910505103965	RC455B 36S/940 MCW-M U4 L1200 W100 B40	Reflector
910505103978	RC453B 28S/UE840 MXO 9010 L1200 W300 B30	Wide beam
910505103979	RC453B 28S/UE840MXO9010ELP3 L1200W300B30	Wide beam
910505103951	RC455B 36S/940 MXO L1200 W100 B40	Wide beam
910505103953	RC455B 40S/940 MXO L1200 W100 B40	Wide beam
910505103954	RC455B 36S/940 MXO L1200 W125 B40	Wide beam
910505103955	RC455B 36S/940 MXO L1200 W150 B40	Wide beam
910505103956	RC455B 28S/940 MXO L1200 W150 B40	Wide beam
910505103937	RC455B 40S/940 DLO U4 W3 L1722 W100 B30	Wide beam office compliant
910505103940	RC455B 36S/940 DLO L1200 W100 B30	Wide beam office compliant
910505103936	RC455B 36S/940 DLO 9010U4W3 L1722W150B30	Wide beam office compliant
910505103967	RC455B 40S/940 MCB-M W3W2 L1722 W150 B30	Reflector
910505103948	RC455B 28S/TW9 MLO U4 L1200 W100 B40	Wide beam office compliant
910505103962	RC455B 36S/940 MCB-M L1200 W100 B40	Reflector
910505103964	RC455B 40S/940 MCB-M L1200 W100 B40	Reflector
910505103966	RC455B 36S/940 MCB-M U4 L1200 W100 B40	Reflector
910505103938	RC455B 40S/940 DLO W3W2 L1722 W150 B30	Wide beam office compliant

Order Code	Full Product Name	Optic type
910505103939	RC455B 36S/940 DLO W3W2 L1722 W185 B30	Wide beam office compliant
910505103973	RC453B 42S/940 DLO 9010 U4 L1200 W300B30	Wide beam office compliant
910505103981	RC453B 40S/TW9 DLO U4 L1200 W300 B30	Wide beam office compliant
910505103980	RC453B 28S/UE840 MXO9010ELP3L1200W150B30	Wide beam
910505103982	RC453B 28S/UE840 MXO L1200 W150 B30	Wide beam
910505103941	RC455B 28S/940 MLO L1200 W100 B40	Wide beam office compliant
910505103942	RC455B 36S/940 MLO L1200 W100 B40	Wide beam office compliant
910505103943	RC455B 36S/940 MLO L1200 W125 B40	Wide beam office compliant
910505103944	RC455B 36S/940 MLO L1200 W150 B40	Wide beam office compliant
910505103945	RC455B 40S/940 MLO L1200 W100 B40	Wide beam office compliant
910505103946	RC455B 48S/940 MLO L1495 W100 B40	Wide beam office compliant
910505103947	RC455B 28S/TW9 MLO L1200 W100 B40	Wide beam office compliant
910505103971	RC453B 28S/840 DLO L1200 W300 B30	Wide beam office compliant
910505103972	RC453B 28S/840 DLO 9010 ELP3L1200W300B30	Wide beam office compliant
910505103977	RC453B 28S/840 DLO L1195 W298 B30	Wide beam office compliant
910505103961	RC455B 36S/940 MCW-M L1200 W100 B40	Reflector
910505103963	RC455B 40S/940 MCW-M L1200 W100 B40	Reflector
910505103968	RC455B 40S/940MCW-M U4W3 L1722 W150 B40	Reflector
910505103975	RC453B 36S/940 DLO U5 L1200 W300 B30	Wide beam office compliant

## Operating and Electrical

Order Code	Full Product Name	Power Consumption	Suitable for random switching
910505103952	RC455B 36S/940 MXO U4 L1200 W100 B40	29.5 W	Yes
910505103958	RC455B 40S/TW9 MXO U4 L1200 W100 B40	44.5 W	Yes
910505103960	RC455B 40S/940 MXO ELP3 W6L1722W150B40WT	37 W	No
910505103949	RC455B 28S/TW9 MLO U4 L1720 W124 B40	33 W	Yes
910505103950	RC455B 36S/940 MLO U4 W3 L1722 W100 B40	38 W	Yes
910505103974	RC453B42S/940DLO9010U4ELW3W4L1200W300B30	32 W	Yes
910505103976	RC453B 36S/940 DLO9010U4ELW3L1200W300B30	28.5 W	Yes

Order Code	Full Product Name	Power Consumption	Suitable for random switching
910505103957	RC455B 48S/940 MXO L1495 W100 B40	40.5 W	No
910505103959	RC455B 28S/TWBU MCW-M U4 L1200 W100 B40	37.5 W	Yes
910505103965	RC455B 36S/940 MCW-M U4 L1200 W100 B40	29.5 W	Yes
910505103978	RC453B 28S/UE840 MXO 9010 L1200 W300 B30	19.4 W	No
910505103979	RC453B 28S/UE840MXO9010ELP3 L1200W300B30	25.5 W	No
910505103951	RC455B 36S/940 MXO L1200 W100 B40	30 W	No
910505103953	RC455B 40S/940 MXO L1200 W100 B40	34 W	No
910505103954	RC455B 36S/940 MXO L1200 W125 B40	29 W	No

## TrueBlend Recessed

Order Code	Full Product Name	Power Consumption	Suitable for random switching
910505103955	RC455B 36S/940 MXO L1200 W150 B40	28 W	No
910505103956	RC455B 28S/940 MXO L1200 W150 B40	22 W	No
910505103937	RC455B 40S/940 DLO U4 W3 L1722 W100 B30	26 W	Yes
910505103940	RC455B 36S/940 DLO L1200 W100 B30	24 W	No
910505103936	RC455B 36S/940 DLO 9010U4W3 L1722W150B30	23.5 W	Yes
910505103967	RC455B 40S/940 MCB-M W3W2 L1722 W150 B30	38 W	No
910505103948	RC455B 28S/TW9 MLO U4 L1200 W100 B40	33 W	Yes
910505103962	RC455B 36S/940 MCB-M L1200 W100 B40	34 W	No
910505103964	RC455B 40S/940 MCB-M L1200 W100 B40	38.5 W	No
910505103966	RC455B 36S/940 MCB-M U4 L1200 W100 B40	33.5 W	Yes
910505103938	RC455B 40S/940 DLO W3W2 L1722 W150 B30	26.5 W	No
910505103939	RC455B 36S/940 DLO W3W2 L1722 W185 B30	24 W	No
910505103973	RC453B 42S/940 DLO 9010 U4 L1200 W300B30	26 W	Yes

Order Code	Full Product Name	Power Consumption	Suitable for random switching
910505103981	RC453B 40S/TW9 DLO U4 L1200 W300 B30	36.5 W	Yes
910505103980	RC453B 28S/UE840 MXO9010ELP3L1200W150B30	25.5 W	No
910505103982	RC453B 28S/UE840 MXO L1200 W150 B30	19.4 W	No
910505103941	RC455B 28S/940 MLO L1200 W100 B40	29 W	No
910505103942	RC455B 36S/940 MLO L1200 W100 B40	38 W	No
910505103943	RC455B 36S/940 MLO L1200 W125 B40	36 W	No
910505103944	RC455B 36S/940 MLO L1200 W150 B40	36 W	No
910505103945	RC455B 40S/940 MLO L1200 W100 B40	42.5 W	No
910505103946	RC455B 48S/940 MLO L1495 W100 B40	50 W	No
910505103947	RC455B 28S/TW9 MLO L1200 W100 B40	33 W	No
910505103971	RC453B 28S/840 DLO L1200 W300 B30	17.4 W	No
910505103972	RC453B 28S/840 DLO 9010 ELP3L1200W300B30	23.5 W	No
910505103977	RC453B 28S/840 DLO L1195 W298 B30	22.5 W	No
910505103961	RC455B 36S/940 MCW-M L1200 W100 B40	30 W	No
910505103963	RC455B 40S/940 MCW-M L1200 W100 B40	33.5 W	No
910505103968	RC455B 40S/940MCW-M U4W3 L1722 W150 B40	33 W	Yes
910505103975	RC453B 36S/940 DLO U5 L1200 W300 B30	22.5 W	Yes

### Controls and Dimming

Order Code	Full Product Name	Embedded control
910505103952	RC455B 36S/940 MXO U4 L1200 W100 B40	Upgradable sensor slot with SC200 sensor
910505103958	RC455B 40S/TW9 MXO U4 L1200 W100 B40	Upgradable sensor slot with SC200 sensor
910505103960	RC455B 40S/940 MXO ELP3 W6L1722W150B40WT	-
910505103949	RC455B 28S/TW9 MLO U4 L1720 W124 B40	Upgradable sensor slot with SC200 sensor
910505103950	RC455B 36S/940 MLO U4 W3 L1722 W100 B40	Upgradable sensor slot with SC200 sensor
910505103974	RC453B42S/ 940DLO9010U4ELW3W4L1200W300B30	Upgradable sensor slot with SC200 sensor
910505103976	RC453B 36S/940 DLO9010U4ELW3L1200W300B30	Upgradable sensor slot with SC200 sensor
910505103957	RC455B 48S/940 MXO L1495 W100 B40	-
910505103959	RC455B 28S/TWBU MCW-M U4 L1200 W100 B40	Upgradable sensor slot with SC200 sensor

Order Code	Full Product Name	Embedded control
910505103965	RC455B 36S/940 MCW-M U4 L1200 W100 B40	Upgradable sensor slot with SC200 sensor
910505103978	RC453B 28S/UE840 MXO 9010 L1200 W300 B30	-
910505103979	RC453B 28S/UE840MXO9010ELP3 L1200W300B30	-
910505103951	RC455B 36S/940 MXO L1200 W100 B40	-
910505103953	RC455B 40S/940 MXO L1200 W100 B40	-
910505103954	RC455B 36S/940 MXO L1200 W125 B40	-
910505103955	RC455B 36S/940 MXO L1200 W150 B40	-
910505103956	RC455B 28S/940 MXO L1200 W150 B40	-
910505103937	RC455B 40S/940 DLO U4 W3 L1722 W100 B30	Upgradable sensor slot with SC200 sensor
910505103940	RC455B 36S/940 DLO L1200 W100 B30	-
910505103936	RC455B 36S/940 DLO 9010U4W3 L1722W150B30	Upgradable sensor slot with SC200 sensor
910505103967	RC455B 40S/940 MCB-M W3W2 L1722 W150 B30	-
910505103948	RC455B 28S/TW9 MLO U4 L1200 W100 B40	Upgradable sensor slot with SC200 sensor
910505103962	RC455B 36S/940 MCB-M L1200 W100 B40	-
910505103964	RC455B 40S/940 MCB-M L1200 W100 B40	-

## TrueBlend Recessed

Order Code	Full Product Name	Embedded control
910505103966	RC455B 36S/940 MCB-M U4 L1200 W100 B40	Upgradable sensor slot with SC200 sensor
910505103938	RC455B 40S/940 DLO W3W2 L1722 W150 B30	-
910505103939	RC455B 36S/940 DLO W3W2 L1722 W185 B30	-
910505103973	RC453B 42S/940 DLO 9010 U4 L1200 W300B30	Upgradable sensor slot with SC200 sensor
910505103981	RC453B 40S/TW9 DLO U4 L1200 W300 B30	Upgradable sensor slot with SC200 sensor
910505103980	RC453B 28S/UE840 MXO9010ELP3L1200W150B30	-
910505103982	RC453B 28S/UE840 MXO L1200 W150 B30	-
910505103941	RC455B 28S/940 MLO L1200 W100 B40	-
910505103942	RC455B 36S/940 MLO L1200 W100 B40	-
910505103943	RC455B 36S/940 MLO L1200 W125 B40	-

Order Code	Full Product Name	Embedded control
910505103944	RC455B 36S/940 MLO L1200 W150 B40	-
910505103945	RC455B 40S/940 MLO L1200 W100 B40	-
910505103946	RC455B 48S/940 MLO L1495 W100 B40	-
910505103947	RC455B 28S/TW9 MLO L1200 W100 B40	-
910505103971	RC453B 28S/840 DLO L1200 W300 B30	-
910505103972	RC453B 28S/840 DLO 9010 ELP3L1200W300B30	-
910505103977	RC453B 28S/840 DLO L1195 W298 B30	-
910505103961	RC455B 36S/940 MCW-M L1200 W100 B40	-
910505103963	RC455B 40S/940 MCW-M L1200 W100 B40	-
910505103968	RC455B 40S/940MCW-M U4W3 L1722 W150 B40	Upgradable sensor slot with SC200 sensor
910505103975	RC453B 36S/940 DLO U5 L1200 W300 B30	Interact SC1500 Multi-sensor bundle

### Mechanical and Housing

Order Code	Full Product Name	Optical cover type
910505103952	RC455B 36S/940 MXO U4 L1200 W100 B40	Micro Hexagonal Optic
910505103958	RC455B 40S/TW9 MXO U4 L1200 W100 B40	Micro Hexagonal Optic
910505103960	RC455B 40S/940 MXO ELP3 W6L1722W150B40WT	Micro Hexagonal Optic
910505103949	RC455B 28S/TW9 MLO U4 L1720 W124 B40	Micro-lens optic
910505103950	RC455B 36S/940 MLO U4 W3 L1722 W100 B40	Micro-lens optic
910505103974	RC453B42S/940DLO9010U4ELW3W4L1200W300B30	Acrylic bowl/ cover frosted
910505103976	RC453B 36S/940 DLO9010U4ELW3L1200W300B30	Acrylic bowl/ cover frosted
910505103957	RC455B 48S/940 MXO L1495 W100 B40	Micro Hexagonal Optic
910505103959	RC455B 28S/TWBU MCW-M U4 L1200 W100 B40	Micro Hexagonal Optic
910505103965	RC455B 36S/940 MCW-M U4 L1200 W100 B40	-
910505103978	RC453B 28S/UE840 MXO 9010 L1200 W300 B30	Micro Hexagonal Optic
910505103979	RC453B 28S/UE840MXO9010ELP3 L1200W300B30	Micro Hexagonal Optic

Order Code	Full Product Name	Optical cover type
910505103951	RC455B 36S/940 MXO L1200 W100 B40	Micro Hexagonal Optic
910505103953	RC455B 40S/940 MXO L1200 W100 B40	Micro Hexagonal Optic
910505103954	RC455B 36S/940 MXO L1200 W125 B40	Micro Hexagonal Optic
910505103955	RC455B 36S/940 MXO L1200 W150 B40	Micro Hexagonal Optic
910505103956	RC455B 28S/940 MXO L1200 W150 B40	Micro Hexagonal Optic
910505103937	RC455B 40S/940 DLO U4 W3 L1722 W100 B30	Acrylic bowl/ cover frosted
910505103940	RC455B 36S/940 DLO L1200 W100 B30	Acrylic bowl/ cover frosted
910505103936	RC455B 36S/940 DLO 9010U4W3 L1722W150B30	Acrylic bowl/ cover frosted
910505103967	RC455B 40S/940 MCB-M W3W2 L1722 W150 B30	-
910505103948	RC455B 28S/TW9 MLO U4 L1200 W100 B40	Micro-lens optic
910505103962	RC455B 36S/940 MCB-M L1200 W100 B40	-
910505103964	RC455B 40S/940 MCB-M L1200 W100 B40	-
910505103966	RC455B 36S/940 MCB-M U4 L1200 W100 B40	-
910505103938	RC455B 40S/940 DLO W3W2 L1722 W150 B30	Acrylic bowl/ cover frosted

## TrueBlend Recessed

Order Code	Full Product Name	Optical cover type	Order Code	Full Product Name	Optical cover type
910505103939	RC455B 36S/940 DLO W3W2 L1722 W185 B30	Acrylic bowl/ cover frosted	910505103944	RC455B 36S/940 MLO L1200 W150 B40	Micro-lens optic
910505103973	RC453B 42S/940 DLO 9010 U4 L1200 W300B30	Acrylic bowl/ cover frosted	910505103945	RC455B 40S/940 MLO L1200 W100 B40	Micro-lens optic
910505103981	RC453B 40S/TW9 DLO U4 L1200 W300 B30	Micro Hexagonal Optic	910505103946	RC455B 48S/940 MLO L1495 W100 B40	Micro-lens optic
910505103980	RC453B 28S/UE840 MXO9010ELP3L1200W150B30	Micro Hexagonal Optic	910505103947	RC455B 28S/TW9 MLO L1200 W100 B40	Micro-lens optic
910505103982	RC453B 28S/UE840 MXO L1200 W150 B30	Micro Hexagonal Optic	910505103971	RC453B 28S/840 DLO L1200 W300 B30	Acrylic bowl/ cover frosted
910505103941	RC455B 28S/940 MLO L1200 W100 B40	Micro-lens optic	910505103972	RC453B 28S/840 DLO 9010 ELP3L1200W300B30	Acrylic bowl/ cover frosted
910505103942	RC455B 36S/940 MLO L1200 W100 B40	Micro-lens optic	910505103977	RC453B 28S/840 DLO L1195 W298 B30	Acrylic bowl/ cover frosted
910505103943	RC455B 36S/940 MLO L1200 W125 B40	Micro-lens optic	910505103961	RC455B 36S/940 MCW-M L1200 W100 B40	-
			910505103963	RC455B 40S/940 MCW-M L1200 W100 B40	-
			910505103968	RC455B 40S/940MCW-M U4W3 L1722 W150 B40	-
			910505103975	RC453B 36S/940 DLO U5 L1200 W300 B30	Acrylic bowl/ cover frosted

## Emergency Operation

Order Code	Full Product Name	Emergency lighting	Emergency flux	Emergency mode	Power consumption during Central DC (W)	Order Code	Full Product Name	Emergency lighting	Emergency flux	Emergency mode	Power consumption during Central DC (W)
910505103952	RC455B 36S/940 MXO U4 L1200 W100 B40	DC operated central emergency lighting	-	-	-	910505103950	RC455B 36S/940 MLO U4 W3 L1722 W100 B40	DC operated central emergency lighting	-	-	-
910505103958	RC455B 40S/TW9 MXO U4 L1200 W100 B40	DC operated central emergency lighting	-	-	-	910505103974	RC453B42S/940DLO9010U4ELW3W4L1200W300B30	DC operated central emergency lighting	520 lm	-	6 W
910505103960	RC455B 40S/940 MXO ELP3 W6L1722W150B40WT	Emergency lighting 3 hours duration Pro version	405 lm	6 W	-	910505103975	RC453B 36S/940 DLO9010U4ELW3L1200W300B30	DC operated central emergency lighting	520 lm	-	6 W
910505103949	RC455B 28S/TW9 MLO U4 L1720 W124 B40	DC operated central emergency lighting	-	-	-	910505103975	RC455B 48S/940 MXO L1495 W100 B40	DC operated central emergency lighting	-	-	-

# TrueBlend Recessed

Order Code	Full Product Name	Emergency lighting	Emergency flux	Emergency mode	Power consumption during Central	Order Code	Full Product Name	Emergency lighting	Emergency flux	Emergency mode	Power consumption during Central DC
910505103959	RC455B 28S/TWBU MCW-M U4 L1200 W100 B40	DC operated central emergency lighting	-	-	-	910505103937	RC455B 40S/940 DLO U4 W3 L1722 W100 B30	DC operated central emergency lighting	-	-	-
910505103965	RC455B 36S/940 MCW-M U4 L1200 W100 B40	DC operated central emergency lighting	-	-	-	910505103940	RC455B 36S/940 DLO L1200 W100 B30	DC operated central emergency lighting	-	-	-
910505103978	RC453B 28S/UE840 MXO 9010 L1200 W300 B30	DC operated central emergency lighting	-	-	-	910505103936	RC455B 36S/940 DLO 9010U4W3 L1722W150B30	DC operated central emergency lighting	-	-	-
910505103979	RC453B 28S/UE840MXO9010ELP3 L1200W300B30	Emergency lighting 3 hours duration Pro version	405 lm	6 W	-	910505103967	RC455B 40S/940 MCB-M W3W2 L1722 W150 B30	DC operated central emergency lighting	-	-	-
910505103951	RC455B 36S/940 MXO L1200 W100 B40	DC operated central emergency lighting	-	-	-	910505103948	RC455B 28S/TW9 MLO U4 L1200 W100 B40	DC operated central emergency lighting	-	-	-
910505103953	RC455B 40S/940 MXO L1200 W100 B40	DC operated central emergency lighting	-	-	-	910505103962	RC455B 36S/940 MCB-M L1200 W100 B40	DC operated central emergency lighting	-	-	-
910505103954	RC455B 36S/940 MXO L1200 W125 B40	DC operated central emergency lighting	-	-	-	910505103964	RC455B 40S/940 MCB-M L1200 W100 B40	DC operated central emergency lighting	-	-	-
910505103955	RC455B 36S/940 MXO L1200 W150 B40	DC operated central emergency lighting	-	-	-	910505103966	RC455B 36S/940 MCB-M U4 L1200 W100 B40	DC operated central emergency lighting	-	-	-
910505103956	RC455B 28S/940 MXO L1200 W150 B40	DC operated central emergency lighting	-	-	-	910505103938	RC455B 40S/940 DLO W3W2 L1722 W150 B30	DC operated central emergency lighting	-	-	-

# TrueBlend Recessed

Order Code	Full Product Name	Emergency lighting	Emergency flux	Emergency mode	Power consumption during Central	Order Code	Full Product Name	Emergency lighting	Emergency flux	Emergency mode	Power consumption during Central DC
910505103939	RC455B 36S/940 DLO W3W2 L1722 W185 B30	DC operated central emergency lighting	-	-	-	910505103945	RC455B 40S/940 MLO L1200 W100 B40	DC operated central emergency lighting	-	-	-
910505103973	RC453B 42S/940 DLO 9010 U4 L1200 W300B30	DC operated central emergency lighting	-	-	-	910505103946	RC455B 48S/940 MLO L1495 W100 B40	DC operated central emergency lighting	-	-	-
910505103981	RC453B 40S/TW9 DLO U4 L1200 W300 B30	DC operated central emergency lighting	-	-	-	910505103947	RC455B 28S/TW9 MLO L1200 W100 B40	DC operated central emergency lighting	-	-	-
910505103980	RC453B 28S/UE840 MXO9010ELP3L1200W150B30	Emergency lighting 3 hours duration with DALI interface	405 lm	6 W	3 hour(s)	910505103971	RC453B 28S/840 DLO L1200 W300 B30	DC operated central emergency lighting	-	-	-
910505103982	RC453B 28S/UE840 MXO L1200 W150 B30	DC operated central emergency lighting	-	-	-	910505103972	RC453B 28S/840 DLO 9010 ELP3L1200W300B30	Emergency lighting 3 hours duration Pro version	520 lm	6 W	-
910505103941	RC455B 28S/940 MLO L1200 W100 B40	DC operated central emergency lighting	-	-	-	910505103977	RC453B 28S/840 DLO L1195 W298 B30	DC operated central emergency lighting	-	-	-
910505103942	RC455B 36S/940 MLO L1200 W100 B40	DC operated central emergency lighting	-	-	-	910505103961	RC455B 36S/940 MCW-M L1200 W100 B40	DC operated central emergency lighting	-	-	-
910505103943	RC455B 36S/940 MLO L1200 W125 B40	DC operated central emergency lighting	-	-	-	910505103963	RC455B 40S/940 MCW-M L1200 W100 B40	DC operated central emergency lighting	-	-	-
910505103944	RC455B 36S/940 MLO L1200 W150 B40	DC operated central	-	-	-	910505103968	RC455B 40S/940MCW-M U4W3 L1722 W150 B40	DC operated central	-	-	-

Order Code	Full Product Name	Emergency lighting	Emergency flux	Power consumption during Central mode	Order Code	Full Product Name	Emergency lighting	Emergency flux	Power consumption during Central mode
		emergency lighting			910505103975	RC453B 36S/940 DLO U5 L1200 W300 B30	DC operated central emergency lighting	-	-

Initial Performance (IEC Compliant)

Order Code	Full Product Name	Initial chromaticity
910505103952	RC455B 36S/940 MXO U4 L1200 W100 B40	(0.38, 0.38) SDCM $\leq 3.0$
910505103958	RC455B 40S/TW9 MXO U4 L1200 W100 B40	Tunable, SDCM $\leq 3.0$
910505103960	RC455B 40S/940 MXO ELP3 W6L1722W150B40WT	(0.38, 0.38) SDCM $\leq 3.0$
910505103949	RC455B 28S/TW9 MLO U4 L1720 W124 B40	Tunable, SDCM $\leq 3.0$
910505103950	RC455B 36S/940 MLO U4 W3 L1722 W100 B40	(0.38, 0.38) SDCM $\leq 3.0$
910505103974	RC453B42S/ 940DLO9010U4ELW3W4L1200W300B30	(0.38, 0.38) SDCM $\leq 3.0$
910505103976	RC453B 36S/940 DLO9010U4ELW3L1200W300B30	(0.38, 0.38) SDCM $\leq 3.0$
910505103957	RC455B 48S/940 MXO L1495 W100 B40	(0.38, 0.38) SDCM $\leq 3.0$
910505103959	RC455B 28S/TWBU MCW-M U4 L1200 W100 B40	Tunable, SDCM $\leq 3.0$
910505103965	RC455B 36S/940 MCW-M U4 L1200 W100 B40	(0.38, 0.38) SDCM $\leq 3.0$
910505103978	RC453B 28S/UE840 MXO 9010 L1200 W300 B30	(0.38, 0.38) SDCM $\leq 3.0$
910505103979	RC453B 28S/UE840MXO9010ELP3 L1200W300B30	(0.38, 0.38) SDCM $\leq 3.0$
910505103951	RC455B 36S/940 MXO L1200 W100 B40	(0.38, 0.38) SDCM $\leq 3.0$
910505103953	RC455B 40S/940 MXO L1200 W100 B40	(0.38, 0.38) SDCM $\leq 3.0$
910505103954	RC455B 36S/940 MXO L1200 W125 B40	(0.38, 0.38) SDCM $\leq 3.0$
910505103955	RC455B 36S/940 MXO L1200 W150 B40	(0.38, 0.38) SDCM $\leq 3.0$
910505103956	RC455B 28S/940 MXO L1200 W150 B40	(0.38, 0.38) SDCM $\leq 3.0$

Order Code	Full Product Name	Initial chromaticity
910505103937	RC455B 40S/940 DLO U4 W3 L1722 W100 B30	(0.38, 0.38) SDCM $\leq 3.0$
910505103940	RC455B 36S/940 DLO L1200 W100 B30	(0.38, 0.38) SDCM $\leq 3.0$
910505103936	RC455B 36S/940 DLO 9010U4W3 L1722W150B30	(0.38, 0.38) SDCM $\leq 3.0$
910505103967	RC455B 40S/940 MCB-M W3W2 L1722 W150 B30	(0.38, 0.38) SDCM $\leq 3.0$
910505103948	RC455B 28S/TW9 MLO U4 L1200 W100 B40	Tunable, SDCM $\leq 3.0$
910505103962	RC455B 36S/940 MCB-M L1200 W100 B40	(0.38, 0.38) SDCM $\leq 3.0$
910505103964	RC455B 40S/940 MCB-M L1200 W100 B40	(0.38, 0.38) SDCM $\leq 3.0$
910505103966	RC455B 36S/940 MCB-M U4 L1200 W100 B40	(0.38, 0.38) SDCM $\leq 3.0$
910505103938	RC455B 40S/940 DLO W3W2 L1722 W150 B30	(0.38, 0.38) SDCM $\leq 3.0$
910505103939	RC455B 36S/940 DLO W3W2 L1722 W185 B30	(0.38, 0.38) SDCM $\leq 3.0$
910505103973	RC453B 42S/940 DLO 9010 U4 L1200 W300B30	(0.38, 0.38) SDCM $\leq 3.0$
910505103981	RC453B 40S/TW9 DLO U4 L1200 W300 B30	Tunable, SDCM $\leq 3.0$
910505103980	RC453B 28S/UE840 MXO9010ELP3L1200W150B30	(0.38, 0.38) SDCM $\leq 3.0$
910505103982	RC453B 28S/UE840 MXO L1200 W150 B30	(0.38, 0.38) SDCM $\leq 3.0$
910505103941	RC455B 28S/940 MLO L1200 W100 B40	(0.38, 0.38) SDCM $\leq 3.0$
910505103942	RC455B 36S/940 MLO L1200 W100 B40	(0.38, 0.38) SDCM $\leq 3.0$
910505103943	RC455B 36S/940 MLO L1200 W125 B40	(0.38, 0.38) SDCM $\leq 3.0$

# TrueBlend Recessed

Order Code	Full Product Name	Initial chromaticity
910505103944	RC455B 36S/940 MLO L1200 W150 B40	(0.38, 0.38) SDCM $\leq 3.0$
910505103945	RC455B 40S/940 MLO L1200 W100 B40	(0.38, 0.38) SDCM $\leq 3.0$
910505103946	RC455B 48S/940 MLO L1495 W100 B40	(0.38, 0.38) SDCM $\leq 3.0$
910505103947	RC455B 28S/TW9 MLO L1200 W100 B40	Tunable, SDCM $\leq 3.0$
910505103971	RC453B 28S/840 DLO L1200 W300 B30	(0.38, 0.38) SDCM $\leq 3.0$
910505103972	RC453B 28S/840 DLO 9010 ELP3L1200W300B30	(0.38, 0.38) SDCM $\leq 3.0$

Order Code	Full Product Name	Initial chromaticity
910505103977	RC453B 28S/840 DLO L1195 W298 B30	(0.38, 0.38) SDCM $\leq 3.0$
910505103961	RC455B 36S/940 MCW-M L1200 W100 B40	(0.38, 0.38) SDCM $\leq 3.0$
910505103963	RC455B 40S/940 MCW-M L1200 W100 B40	(0.38, 0.38) SDCM $\leq 3.0$
910505103968	RC455B 40S/940MCW-M U4W3 L1722 W150 B40	(0.38, 0.38) SDCM $\leq 3.0$
910505103975	RC453B 36S/940 DLO U5 L1200 W300 B30	(0.38, 0.38) SDCM $\leq 3.0$

## Polar Wide Diagrams

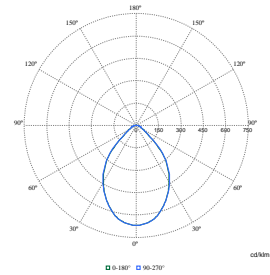
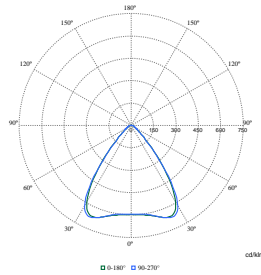
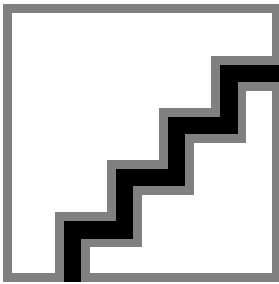

Polar Normal (separate) - RC450BI - 910505103949

Polar Normal (separate) - RC450BI - 910505103973

Polar Normal (separate) - RC450BI - 910505103943

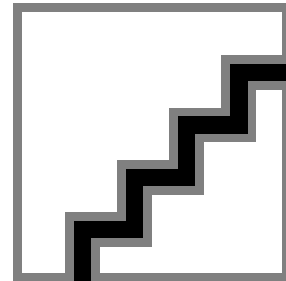
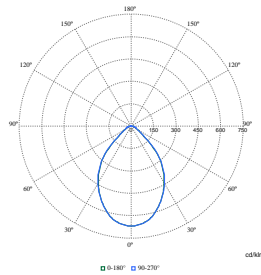
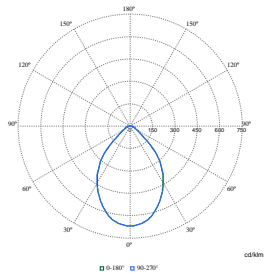

Polar Normal (separate) - RC450BI - 910505103948

Polar Normal (separate) - RC450BI - 910505103941

Polar Normal (separate) - RC450BI - 910505103946

## Polar Wide Diagrams

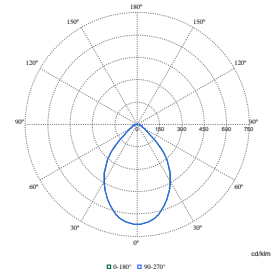
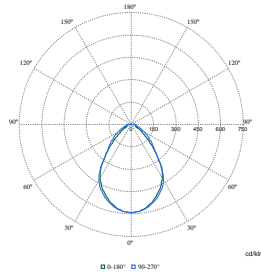
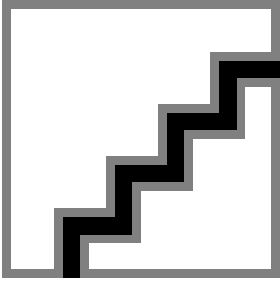

**Polar Normal (separate) - RC450BI - 910505103960**

**Polar Normal (separate) - RC450BI - 910505103980**

**Polar Normal (separate) - RC450BI - 910505103942**

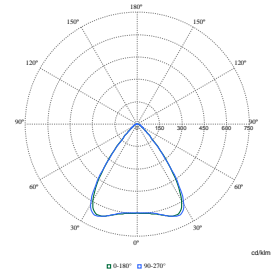
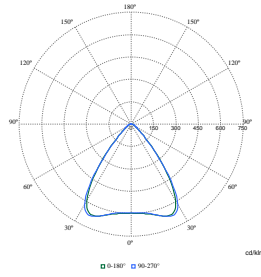
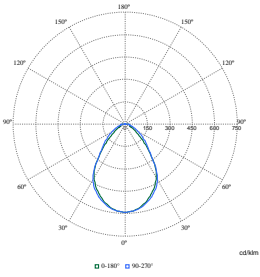

**Polar Normal (separate) - RC450BI - 910505103955**

**Polar Normal (separate) - RC450BI - 910505103974**

**Polar Normal (separate) - RC450BI - 910505103981**

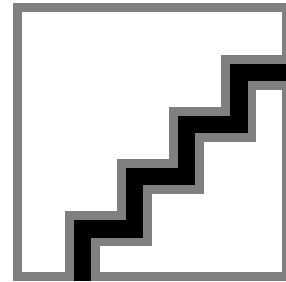
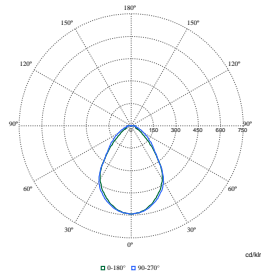
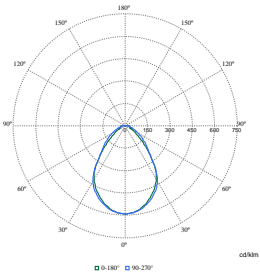

**Polar Normal (separate) - RC450BI - 910505103954**

**Polar Normal (separate) - RC450BI - 910505103978**

**Polar Normal (separate) - RC450BI - 910505103944**

Polar Wide Diagrams

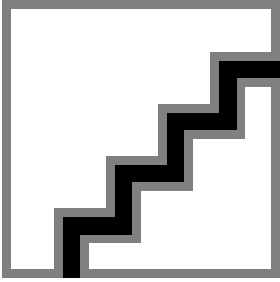

Polar Normal (separate) - RC450BI - 910505103958

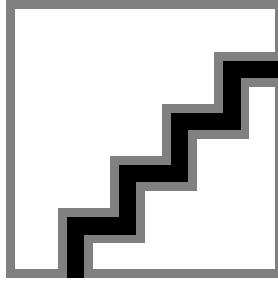

Polar Normal (separate) - RC450BI - 910505103967

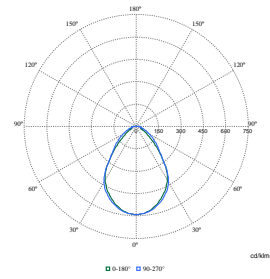

Polar Normal (separate) - RC450BI - 910505103953

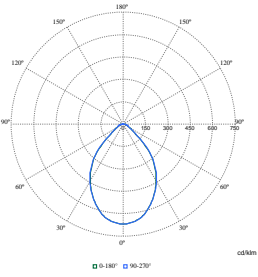

Polar Normal (separate) - RC450BI - 910505103947

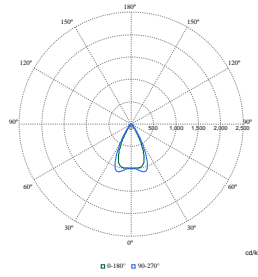

Polar Normal (separate) - RC450BI - 910505103964

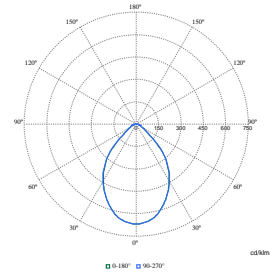

Polar Normal (separate) - RC450BI - 910505103945

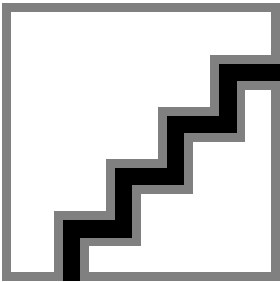

Polar Normal (separate) - RC450BI - 910505103957

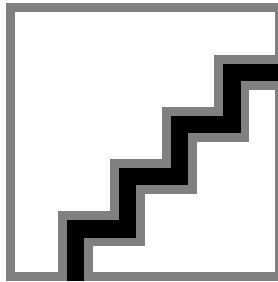

Polar Normal (separate) - RC450BI - 910505103950

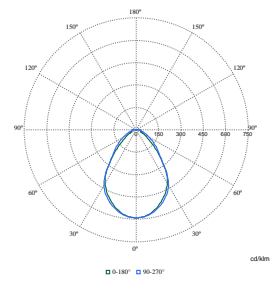

Polar Normal (separate) - RC450BI - 910505103952

# TrueBlend Recessed

## Polar Wide Diagrams

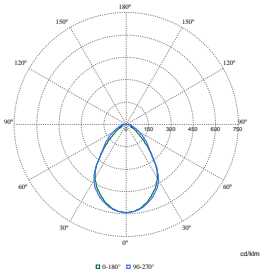

**Polar Normal (separate) - RC450BI - 910505103956**

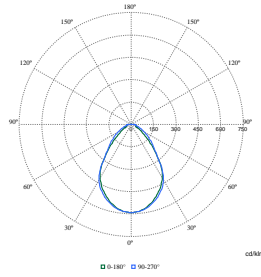

**Polar Normal (separate) - RC450BI - 910505103979**

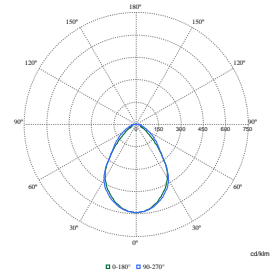

**Polar Normal (separate) - RC450BI - 910505103951**

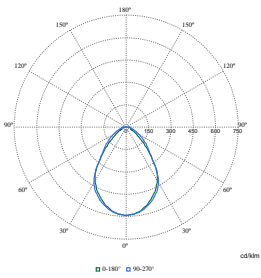

**Polar Normal (separate) - RC450BI - 910505103982**

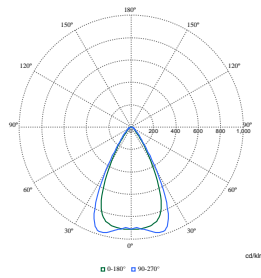

**Polar Normal (separate) - RC450BI - 910505103961**

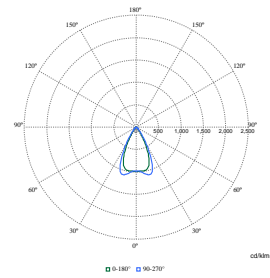

**Polar Normal (separate) - RC450BI - 910505103962**

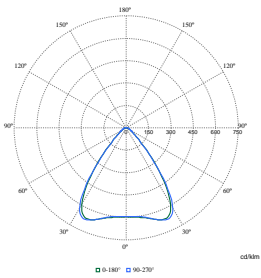

**Polar Normal (separate) - RC450BI - 910505103940**

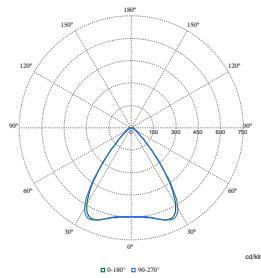

**Polar Normal (separate) - RC450BI - 910505103971**

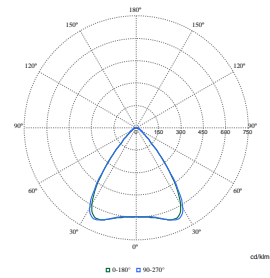

**Polar Normal (separate) - RC450BI - 910505103972**

## Polar Wide Diagrams

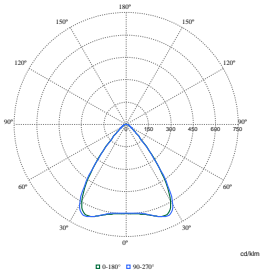

Polar Normal (separate) - RC450BI - 910505103977

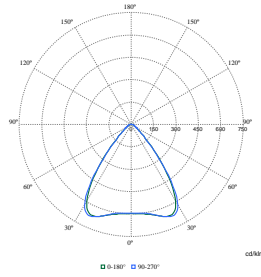

Polar Normal (separate) - RC450BI - 910505103976

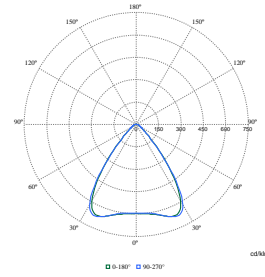

Polar Normal (separate) - RC450BI - 910505103975

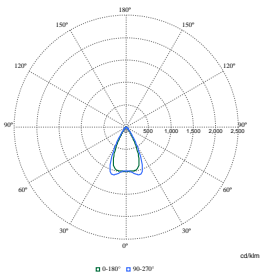

Polar Normal (separate) - RC450BI - 910505103966

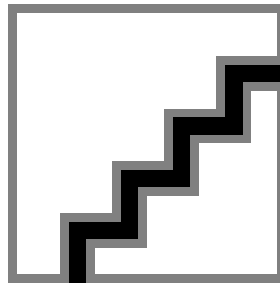

Polar Normal (separate) - RC450BI - 910505103968

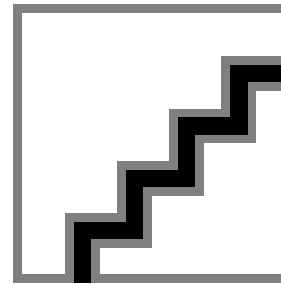

Polar Normal (separate) - RC450BI - 910505103937

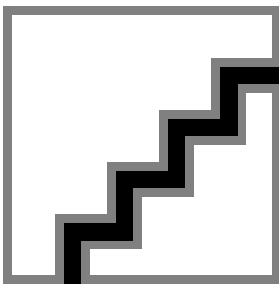

Polar Normal (separate) - RC450BI - 910505103936

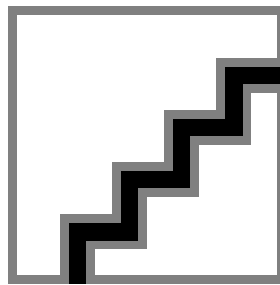

Polar Normal (separate) - RC450BI - 910505103938

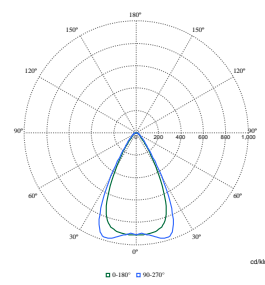

Polar Normal (separate) - RC450BI - 910505103965

# TrueBlend Recessed

## Polar Wide Diagrams

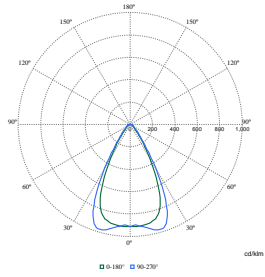

**Polar Normal (separate) - RC450BI -  
910505103963**

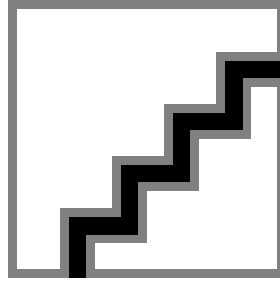

**Polar Normal (separate) - RC450BI -  
910505103939**

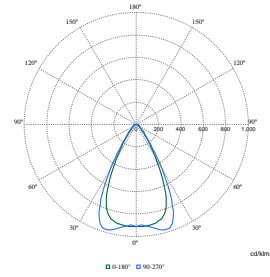

**Polar Normal (separate) - RC450BI -  
910505103959**

