



# TrueBlend: Proposition build around flexibility, choice, and performance.

## TrueBlend Recessed

When specifying lighting for premium office applications, technical specifiers need to deal with a wide variety of requirements and constraints linked to ceiling types and customer/architect preferences. Philips TrueBlend is a flexible luminaire portfolio offering choice in look & feel for the architect, and mechanical fit to many different ceiling types, and a palette of optics to choose from. Philips TrueBlend is built around flexibility and choice; our new recessed office range is a perfect fit for your non-standard ceiling or renovation project where luminaires need to fit the hole of existing luminaires. A wide variety of optics, best-in-class efficacy, combined with our wellbeing led spectra, and Interact connectivity, offers choice in performance and look & feel. TrueBlend helps save energy & provide the right level of light. Not only is it compliant with the WELL Building Standard for Light, but also is rated UGR<19, which is compliant with all office norms (OC). This luminaire family is available in different lengths, light outputs, optics, housing colors, various bracket height, connectors. This offers the ultimate design flexibility and unlimited possibilities. TrueBlend luminaires offer state-of-the-art efficacy and excellent light quality (CRI>90) with upgradability features and repairability that promises a long lifetime. They are also designed for recyclability, making them a truly circular, green choice. So, TrueBlend is an all-in-one solution with superior lighting specifications combined with sustainable approach to high-performance office lighting.

# TrueBlend Recessed

## Benefits

- Designed for enhanced well-being of people with high quality of light.
- Best-in-class efficacy with superior lighting specifications & long lifetime
- Sustainable, future-ready, scalable smart office capabilities with best-in-class Interact proposition.
- Significantly reduces operational costs for an attractive payback time.

## Features

- Best-in-class efficacy up to 170lm/W supports green building design and energy saving subsidy criteria.
- Office-compliant lighting with wide optics choices like DLO, MLO & mini cups.
- Highly uniform lighting with excellent glare control (UGR<19, L65<3000cd/m2)
- 3000K, 4000K, Tunable White & tunable white bio-up versions, all CRI>90
- Long lifetime upto L90@50,000 hours
- Wide connector choice for simpler & faster installation
- Connected system ready with Interact Pro scalable platform using integrated sensors and/or wireless drivers for data collection, occupancy, daylight regulation and wayfinding.
- Prepared for circularity (no glue, replaceable electronics, upgradable system, efficient and long lifetime) plus supporting Environmental Product Declaration (EPD) guide.
- Recessed mounting options, including all accessories.

## Application

- Offices
- Education
- Retail

## Warnings and Safety

- The product is IP20 and, as such, is not protected against water ingress. Therefore, we strongly recommend that the environment in which the luminaire is to be installed is suitably checked.
- If the above advice is not taken and the luminaires are subject to water ingress, Philips / Signify cannot guarantee safe failure and the product warranty will become void.

## Versions



# TrueBlend Recessed

## Versions



TrueBlend Recessed RC453B MXO



TrueBlend Recessed RC455B DLO U4



TrueBlend Recessed RC455B DLO 4Ft



TrueBlend Recessed RC455B MINI CUPS WH U4



TrueBlend Recessed RC455X DLO U4



TrueBlend Recessed RC455B DLO U4



TrueBlend Recessed RC453X DLO U4



TrueBlend Recessed RC455B MLO U4 4FT



TrueBlend Recessed RC455B DLO



TrueBlend Recessed RC453X MXO



TrueBlend Recessed RC455B MINI CUPS WH C



TrueBlend Recessed RC455B MINI CUPS WH U4

# TrueBlend Recessed

## Versions



TrueBlend Recessed RC453B DLO  
U5

## Dimensional drawing

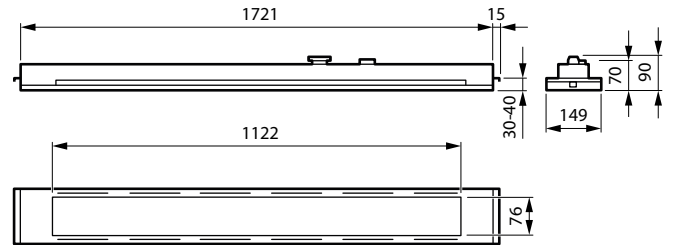
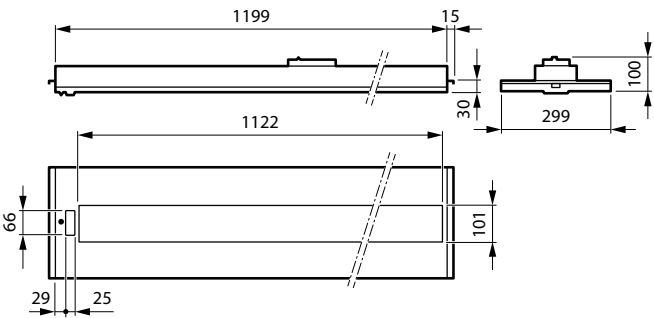
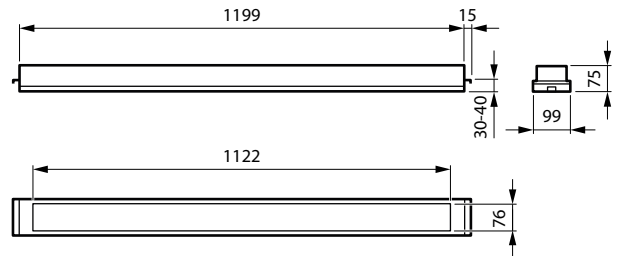
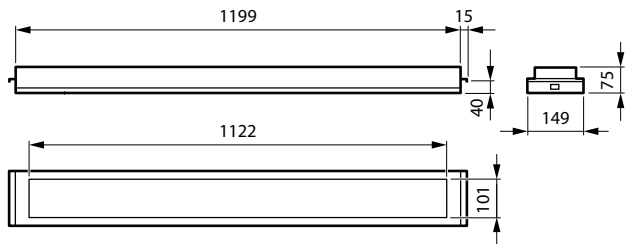
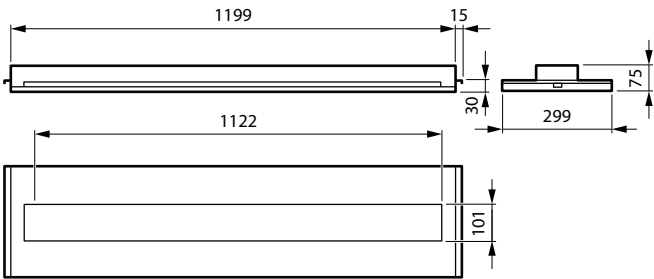

# TrueBlend Recessed

## Dimensional drawing

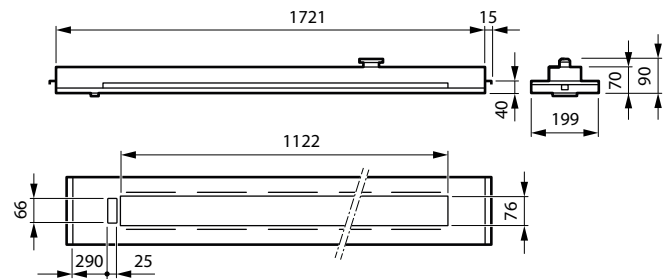
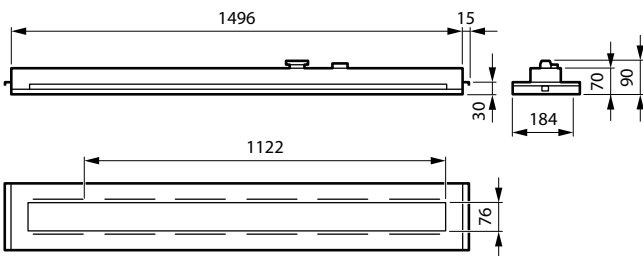
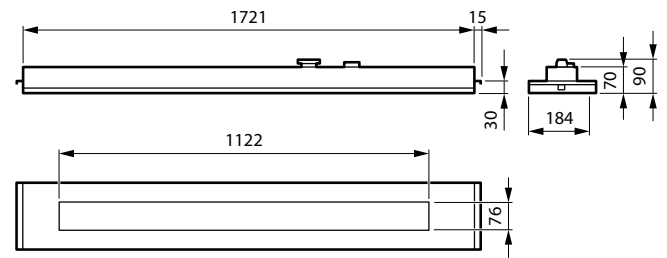
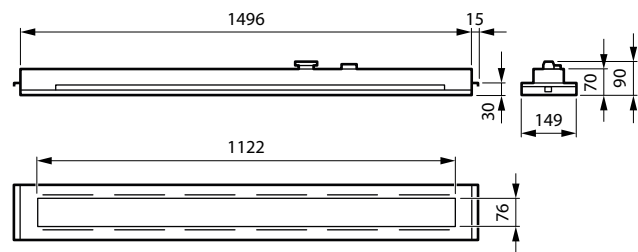
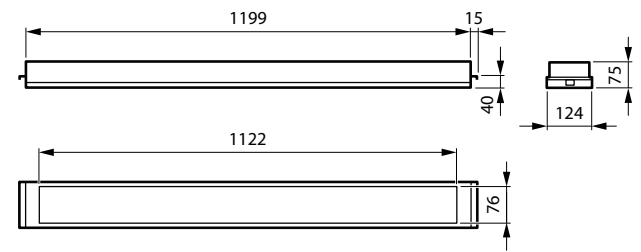
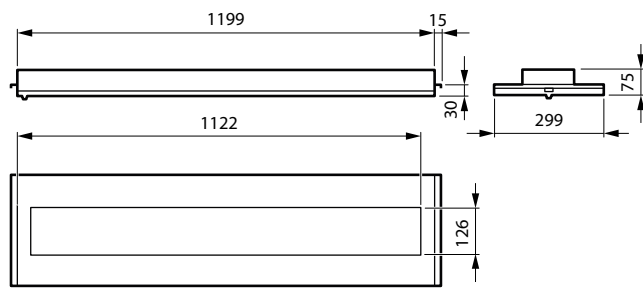
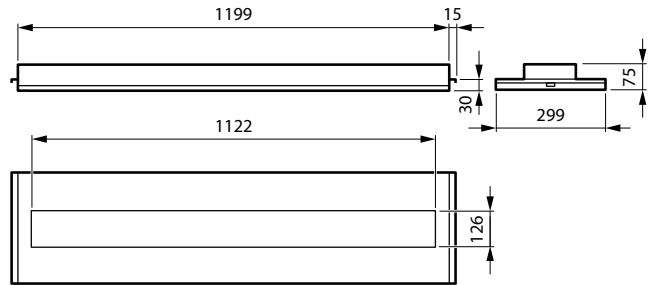
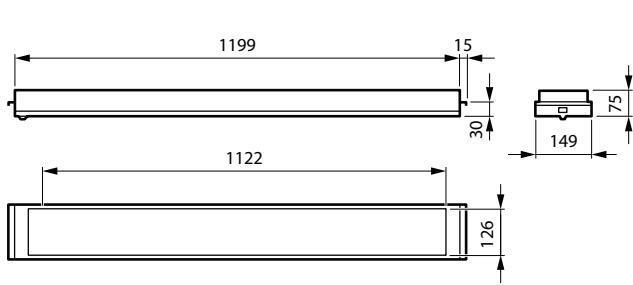

# TrueBlend Recessed

## Dimensional drawing

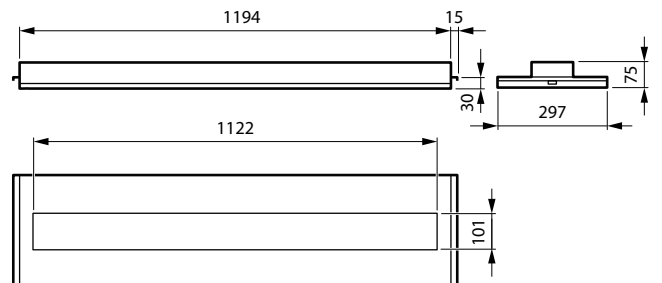
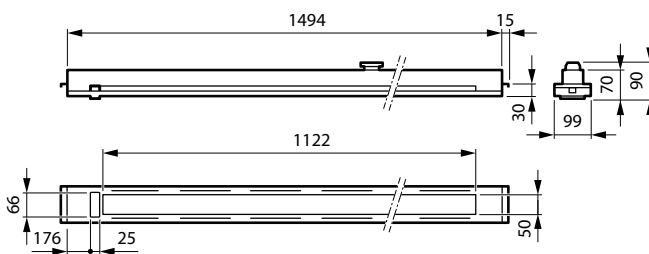
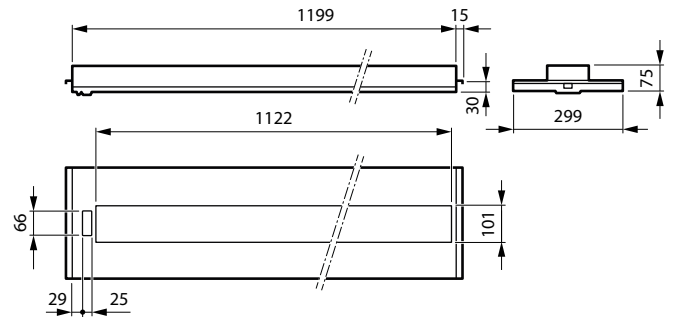
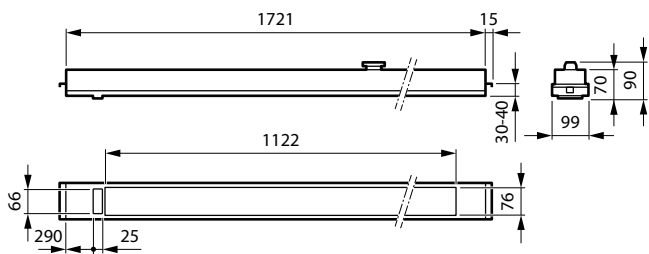
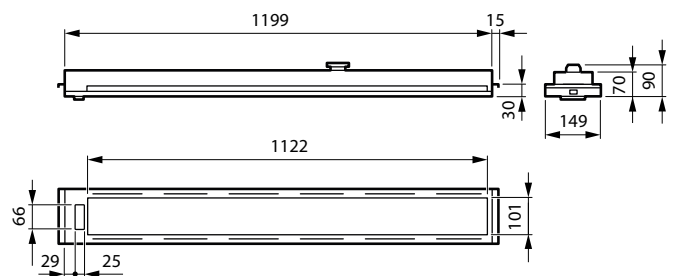
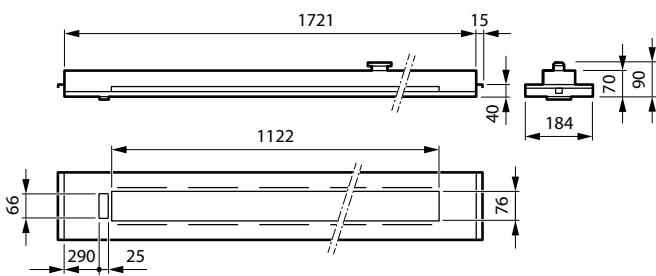
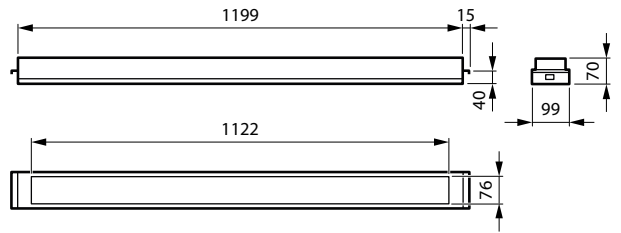
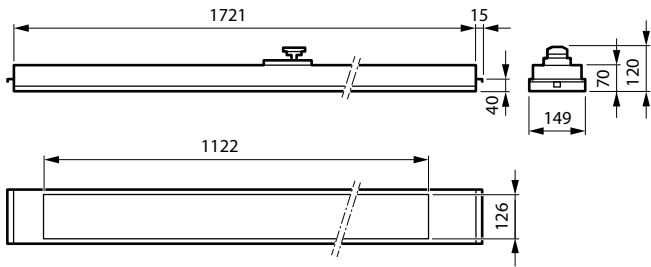

# TrueBlend Recessed

## Dimensional drawing

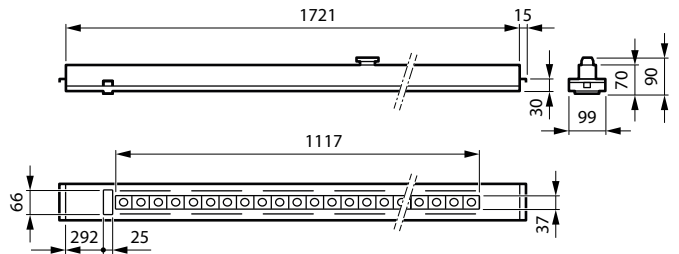
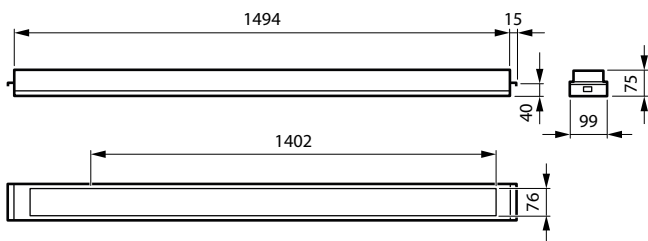
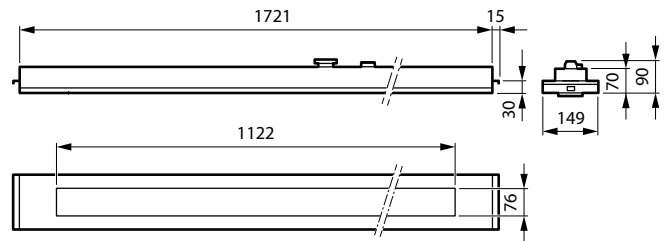
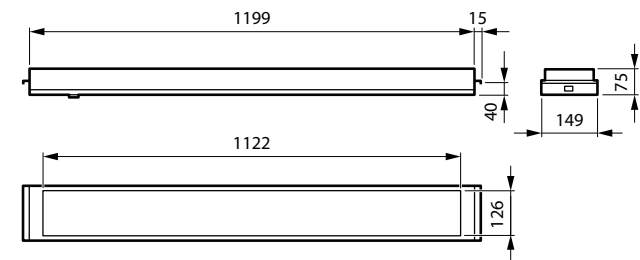
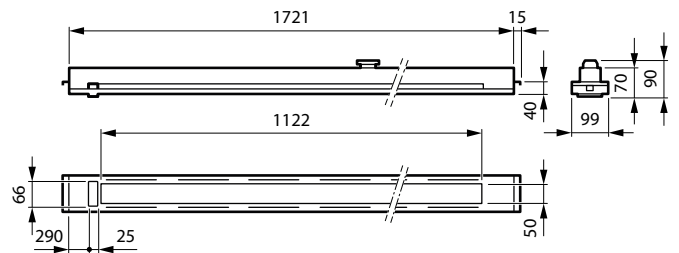
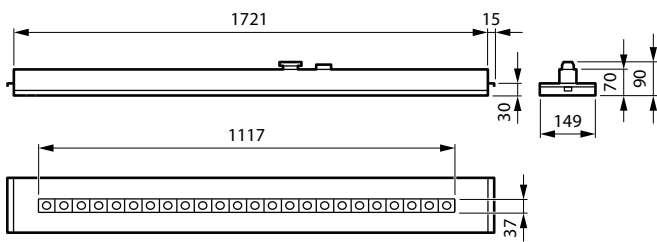
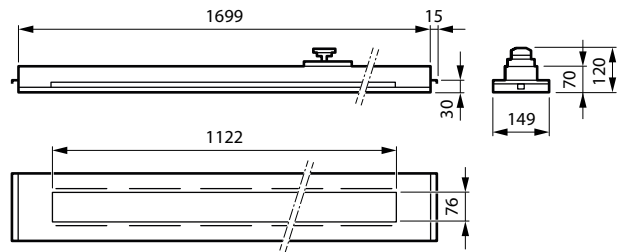
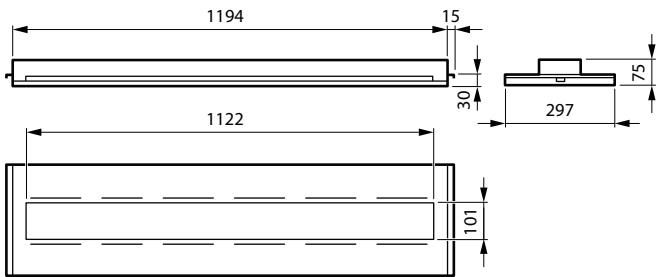

# TrueBlend Recessed

## Dimensional drawing

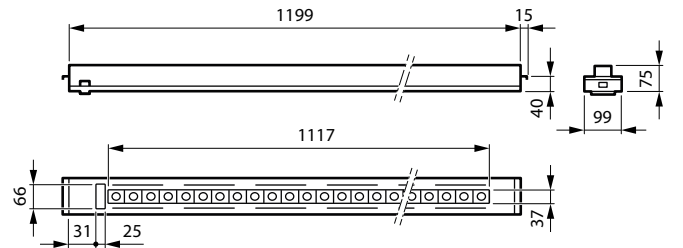
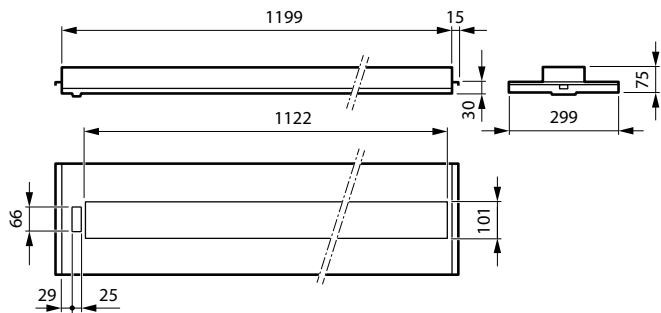
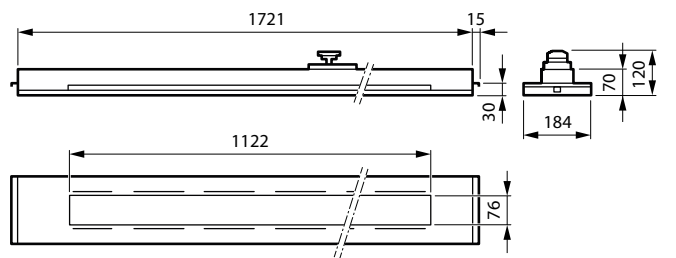
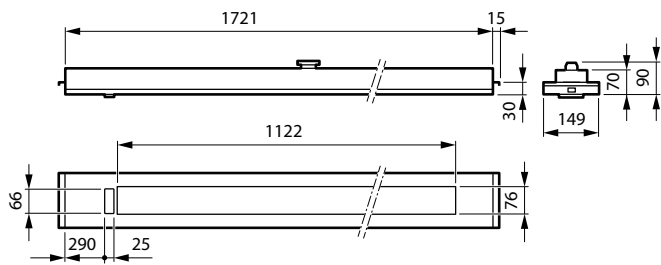
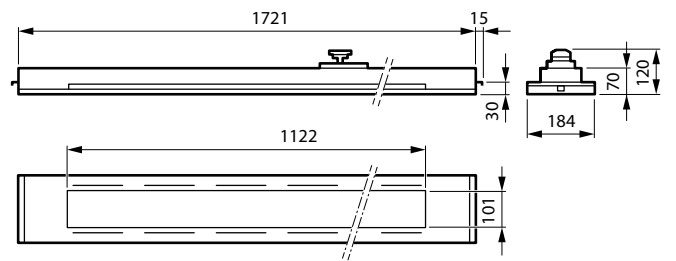
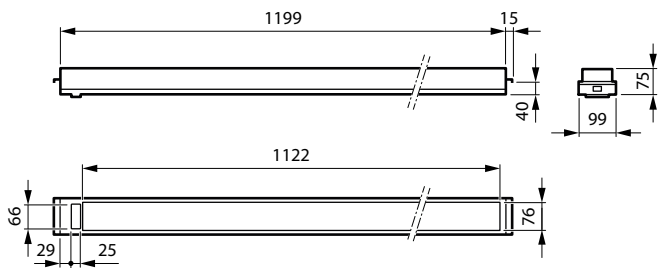
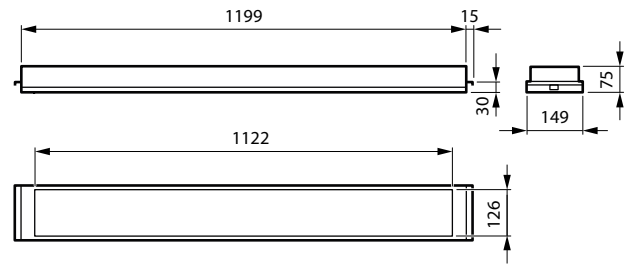
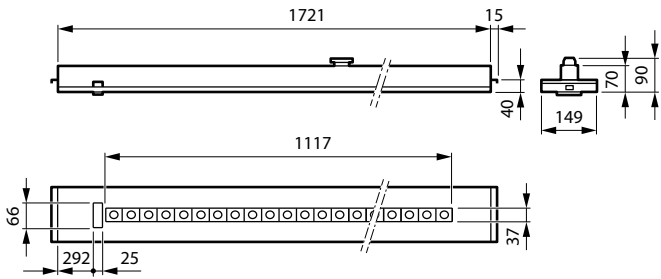

# TrueBlend Recessed

## Dimensional drawing

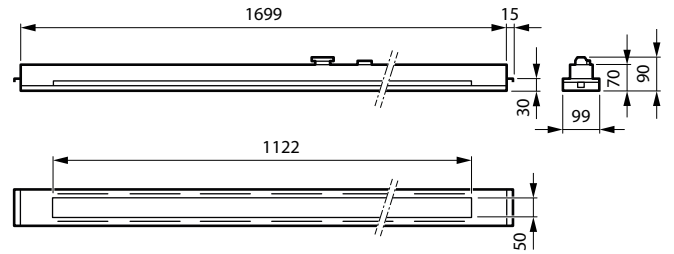
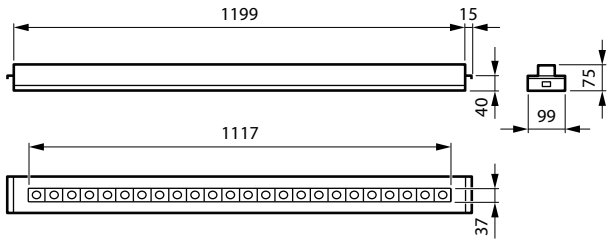

## Product details



TrueBlend Recessed DLO- optics  
DPP



TrueBlend Recessed U5 sensor



TrueBlend Recessed MXO- optics  
DPP



TrueBlend Recessed Mini cups-  
Black optics DPP



TrueBlend Recessed T profile



TrueBlend Recessed U4 sensor



TrueBlend Recessed U4 & EL  
indicator DPP

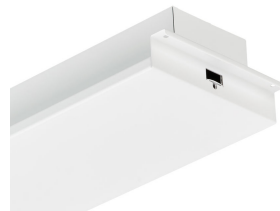

TrueBlend Recessed C profile

# TrueBlend Recessed

## Product details



TrueBlend Recessed Mini cups-  
White optics DPP



TrueBlend Recessed EL indicator

### General Information

Driver included	Yes
Number of gear units	1 unit

### Operating and Electrical

Protection class IEC	Safety class I
Input Voltage	220 to 240 V
Line Frequency	50 to 60 Hz

### Controls and Dimming

Dimmable	Yes
Maximum dim level	1%

### Mechanical and Housing

Housing Color	White
Mech. impact protection code	IK03
Ingress protection code	IP20

### Emergency Operation

Central Emergency	Yes
-------------------	-----

### Approval and Application

Ambient temperature range	+10 to +35 °C
CE mark	Yes
ENEC mark	ENEC mark
Flammability mark	For mounting on normally flammable surfaces
Glow-wire test	Temperature 850 °C, duration 30 s

### Initial Performance (IEC Compliant)

Luminous flux tolerance	+/-10%
-------------------------	--------

### General Information

Order Code	Full Product Name	Lamp family code	Service tag
910505103952	RC455B 36S/940 MXO U4 L1200 W100 B40	36S	Yes
910505103958	RC455B 40S/TW9 MXO U4 L1200 W100 B40	40S	Yes
910505103960	RC455B 40S/940 MXO ELP3 W6L1722W150B40WT	40S	Yes
910505103949	RC455B 28S/TW9 MLO U4 L1720 W124 B40	40S	Yes
910505103950	RC455B 36S/940 MLO U4 W3 L1722 W100 B40	36S	Yes
910505103974	RC453B42S/940DLO9010U4ELW3W4L1200W300B30	42S	Yes
910505103976	RC453B 36S/940 DLO9010U4ELW3L1200W300B30	34S	Yes
910505103957	RC455B 48S/940 MXO L1495 W100 B40	48S	Yes
910505103959	RC455B 28S/TWBU MCW-M U4 L1200 W100 B40	40S	Yes
910505103965	RC455B 36S/940 MCW-M U4 L1200 W100 B40	36S	Yes
910505103978	RC453B 28S/UE840 MXO 9010 L1200 W300 B30	28S	Yes
910505103979	RC453B 28S/UE840MXO9010ELP3 L1200W300B30	28S	Yes
910505103951	RC455B 36S/940 MXO L1200 W100 B40	36S	Yes
910505103953	RC455B 40S/940 MXO L1200 W100 B40	40S	Yes
910505103954	RC455B 36S/940 MXO L1200 W125 B40	36S	Yes
910505103955	RC455B 36S/940 MXO L1200 W150 B40	36S	Yes
910505103956	RC455B 28S/940 MXO L1200 W150 B40	28S	Yes
910505105905	RC455B 40S/940 MXO L1200 W100 B40 SC	-	-
910505103937	RC455B 40S/940 DLO U4 W3 L1722 W100 B30	40S	Yes
910505103940	RC455B 36S/940 DLO L1200 W100 B30	36S	Yes
910505103934	RC455X 36S/940 MCW-M U4 W3 L1722 W100B30	36S	Yes
910505105902	RC455B 36S/940 MCW-M U4W3L1722W100B30SC	-	-
910505103926	RC455X 40S/940 DLO W3W2 L1700 W100 B30	40S	Yes
910505103927	RC455X 40S/940 DLO W3W2 L1497 W150 B30	40S	Yes
910505105901	RC455X 40S/940 DLO W3W2 L1497W150B30 SC	-	-
910505105913	RC455B 40S/UE 840 DLO L1200 W100 B30	-	-
910505103924	RC455X 36S/940 DLO U4 W3 L1722 W200 B40	36S	Yes
910505105911	RC455X 36S/UE840 DLO U4 W3 L1722W200B40	-	-
910505103936	RC455B 36S/940 DLO 9010U4W3 L1722W150B30	36S	Yes
910505103985	RC453X 28S/UE840MXO9010 U4W3L1200W150B30	28S	Yes
910505103921	RC455X 28S/TWBU MCB-M U4 W3 L1722W100B30	36S	Yes
910505103935	RC455X 36S/940 MCB-M U4 W3 L1722 W100B30	36S	Yes
910505103967	RC455B 40S/940 MCB-M W3W2 L1722 W150 B30	40S	Yes
910505103948	RC455B 28S/TW9 MLO U4 L1200 W100 B40	36S	Yes
910505103918	RC455X 36S/940 DLO W5 L1722 W185 B30 WT	36S	Yes
910505103930	RC455X 40S/940 DLO W3W2 L1497 W185 B30	40S	Yes
910505103932	RC455X 36S/940 MLO W5 L1722 W185 B30 WT	36S	Yes
910505105912	RC455B 36S/UE840 DLO W3W2 L1722 W185 B30	-	-
910505103962	RC455B 36S/940 MCB-M L1200 W100 B40	36S	Yes

# TrueBlend Recessed

Order Code	Full Product Name	Lamp family code	Service tag
910505103964	RC455B 40S/940 MCB-M L1200 W100 B40	40S	Yes
910505103966	RC455B 36S/940 MCB-M U4 L1200 W100 B40	36S	Yes
910505103938	RC455B 40S/940 DLO W3W2 L1722 W150 B30	40S	Yes
910505103939	RC455B 36S/940 DLO W3W2 L1722 W185 B30	36S	Yes
910505103917	RC455X 40S/940 DLO W3W2 L1722 W150 B30	40S	Yes
910505103919	RC455X 40S/940 DLO W3W2 L1722 W150 B40	40S	Yes
910505103922	RC455X 40S/930 DLO W3W2 L1722 W150 B30	40S	Yes
910505103925	RC455X 36S/940 DLO W5 L1700 W150 B30 WT	36S	Yes
910505105910	RC455X 40S/UE840 DLO W3W2 L1722 W150 B40	-	-
910505105918	RC455X 40S/BU840 DLO W3W2 L1722 W150 B30	-	-
910505103973	RC453B 42S/940 DLO 9010 U4 L1200 W300B30	42S	Yes
910505103981	RC453B 40S/TW9 DLO U4 L1200 W300 B30	28S	Yes
910505105909	RC453B 42S/940 DLO9010U4 L1200W300B30 SC	-	-
910505105915	RC453B 42S/UE840 DLO9010 U4 L1200W300B30	-	-
910505103984	RC453X 28S/840 DLO L1195 W298 B30	28S	Yes
910505103980	RC453B 28S/UE840 MXO9010ELP3L1200W150B30	28S	Yes
910505103982	RC453B 28S/UE840 MXO L1200 W150 B30	28S	Yes
910505103941	RC455B 28S/940 MLO L1200 W100 B40	28S	Yes
910505103942	RC455B 36S/940 MLO L1200 W100 B40	36S	Yes
910505103943	RC455B 36S/940 MLO L1200 W125 B40	36S	Yes
910505103944	RC455B 36S/940 MLO L1200 W150 B40	36S	Yes
910505103945	RC455B 40S/940 MLO L1200 W100 B40	40S	Yes
910505103946	RC455B 48S/940 MLO L1495 W100 B40	48S	Yes
910505103947	RC455B 28S/TW9 MLO L1200 W100 B40	40S	Yes
910505105903	RC455B 28S/940 MLO L1200 W100 B40 SC	-	-
910505105904	RC455B 40S/940 MLO L1200 W100 B40 SC	-	-
910505105917	RC455B 40S/BU840 MLO L1200 W100 B40	-	-
910505103971	RC453B 28S/840 DLO L1200 W300 B30	28S	Yes
910505103972	RC453B 28S/840 DLO 9010 ELP3L1200W300B30	28S	Yes
910505103977	RC453B 28S/840 DLO L1195 W298 B30	28S	Yes
910505105907	RC453B 28S/840 DLO L1200W300B30 SC	-	-
910505105908	RC453B 40S/UE840 DLO L1200W300B30 SC	-	-
910505105914	RC453B 28S/UE840 DLO L1200 W300 B30	-	-
910505105916	RC453B 28S/BU840 DLO L1200W300B30	-	-
910505103961	RC455B 36S/940 MCW-M L1200 W100 B40	36S	Yes
910505103963	RC455B 40S/940 MCW-M L1200 W100 B40	40S	Yes
910505105906	RC455B 36S/940 MCW-M L1200W100B40 SC	-	-
910505103968	RC455B 40S/940MCW-M U4W3 L1722 W150 B40	40S	Yes
910505103916	RC455X 36S/940 DLO U4 W3 L1722 W100 B30	36S	Yes
910505103920	RC455X 40S/TW9 DLO U4 W3 L1722 W100 B30	40S	Yes
910505103923	RC455X 36S/940 DLOU5 9016W3 L1722W185B40	36S	Yes
910505103931	RC455X 36S/930 DLO U4 W3 L1495 W100 B30	36S	Yes
910505103975	RC453B 36S/940 DLO U5 L1200 W300 B30	34S	Yes

## Light Technical (1/2)

Order Code	Full Product Name	Beam angle of light source	Correlated Color Temperature (Nom)	Color rendering index (CRI)	Order Code	Full Product Name	Beam angle of light source	Correlated Color Temperature (Nom)	Color rendering index (CRI)	Lum. Effic. (rate)
910505103952	RC455B 36S/940 MXO U4 L1200 W100 B40	-	4000 K	>90	910505103958	RC455B 40S/TW9 MXO U4 L1200 W100 B40	-	Tunable white	>90	90 l

# TrueBlend Recessed

Order Code	Full Product Name	Beam angle of light source	Correlated Color Temperature (Nom)	Color rendering index (CRI)	Order Code	Full Product Name	Beam angle of light source	Correlated Color Temperature (Nom)	Color rendering index (CRI)	Lum. Effic. (rate)
			2700-6500 K		910505105911	RC455X 36S/UE840 DLO U4 W3 L1722W200B40	72 degree(s)	4000 K	>80	182
910505103960	RC455B 40S/940 MXO ELP3 W6L1722W150B40WT	-	4000 K	>90	910505103936	RC455B 36S/940 DLO 9010U4W3 L1722W150B30	-	4000 K	>90	153
910505103949	RC455B 28S/TW9 MLO U4 L1720 W124 B40	-	Tunable white	>90	910505103985	RC453X 28S/UE840MXO9010 U4W3L1200W150B30	-	4000 K	>80	112
			2700-6500 K		910505103921	RC455X 28S/TWBU MCB-M U4 W3 L1722W100B30	-	Tunable white	>90	73
910505103950	RC455B 36S/940 MLO U4 W3 L1722 W100 B40	-	4000 K	>90	95 lm/W		-	2700-6500 K		
910505103974	RC453B42S/ 940DLO9010U4ELW3W4L1200W300B30	-	4000 K	>90	910505103935	RC455X 36S/940 MCB-M U4 W3 L1722 W100B30	-	4000 K	>90	107
910505103976	RC453B 36S/940 DLO9010U4ELW3L1200W300B30	-	4000 K	>90	910505103967	RC455B 40S/940 MCB-M W3W2 L1722 W150 B30	-	4000 K	>90	105
910505103957	RC455B 48S/940 MXO L1495 W100 B40	-	4000 K	>90	910505103948	RC455B 28S/TW9 MLO U4 L1200 W100 B40	-	Tunable white	>90	85
910505103959	RC455B 28S/TWBU MCW-M U4 L1200 W100 B40	-	Tunable white	>90	75 lm/W		-	2700-6500 K		
			2700-6500 K		910505103918	RC455X 36S/940 DLO W5 L1722 W185 B30 WT	-	4000 K	>90	150
910505103965	RC455B 36S/940 MCW-M U4 L1200 W100 B40	-	4000 K	>90	122 lm/W		-	4000 K	>90	151
					910505103930	RC455X 40S/940 DLO W3W2 L1497 W185 B30	-	4000 K	>90	100
910505103978	RC453B 28S/UE840 MXO 9010 L1200 W300 B30	-	4000 K	>80	144 lm/W		-	4000 K	>90	182
					910505103932	RC455X 36S/940 MLO W5 L1722 W185 B30 WT	-	4000 K	>80	182
910505103979	RC453B 28S/UE840MXO9010ELP3 L1200W300B30	-	4000 K	>80	110 lm/W		72 degree(s)	4000 K	>80	182
910505103951	RC455B 36S/940 MXO L1200 W100 B40	-	4000 K	>90	120 lm/W		-	4000 K	>90	105
910505103953	RC455B 40S/940 MXO L1200 W100 B40	-	4000 K	>90	910505103962	RC455B 36S/940 MCB-M L1200 W100 B40	-	4000 K	>90	104
910505103954	RC455B 36S/940 MXO L1200 W125 B40	-	4000 K	>90	124 lm/W		-	4000 K	>90	107
910505103955	RC455B 36S/940 MXO L1200 W150 B40	-	4000 K	>90	910505103964	RC455B 40S/940 MCB-M L1200 W100 B40	-	4000 K	>90	107
910505103956	RC455B 28S/940 MXO L1200 W150 B40	-	4000 K	>90	127 lm/W		-	4000 K	>90	107
910505105905	RC455B 40S/940 MXO L1200 W100 B40 SC	72 degree(s)	4000 K	>90	910505103966	RC455B 36S/940 MCB-M U4 L1200 W100 B40	-	4000 K	>90	151
910505103937	RC455B 40S/940 DLO U4 W3 L1722 W100 B30	-	4000 K	>90	910505103938	RC455B 40S/940 DLO W3W2 L1722 W150 B30	-	4000 K	>90	150
910505103940	RC455B 36S/940 DLO L1200 W100 B30	-	4000 K	>90	910505103939	RC455B 36S/940 DLO W3W2 L1722 W185 B30	-	4000 K	>90	151
910505103934	RC455X 36S/940 MCW-M U4 W3 L1722 W100B30	-	4000 K	>90	122 lm/W		-	4000 K	>90	151
					910505103917	RC455X 40S/940 DLO W3W2 L1722 W150 B30	-	4000 K	>90	151
910505105902	RC455B 36S/940 MCW-M U4W3L1722W100B30SC	72 degree(s)	4000 K	>90	122 lm/W		-	4000 K	>90	151
					910505103919	RC455X 40S/940 DLO W3W2 L1722 W150 B40	-	4000 K	>90	151
910505103926	RC455X 40S/940 DLO W3W2 L1700 W100 B30	-	4000 K	>90	140 lm/W		-	3000 K	>90	151
					910505103922	RC455X 40S/930 DLO W3W2 L1722 W150 B30	-	4000 K	>90	150
910505103927	RC455X 40S/940 DLO W3W2 L1497 W150 B30	-	4000 K	>90	151 lm/W		-	4000 K	>90	150
					910505103925	RC455X 36S/940 DLO W5 L1700 W150 B30 WT	-	4000 K	>80	182
910505105901	RC455X 40S/940 DLO W3W2 L1497W150B30 SC	72 degree(s)	4000 K	>90	150.9		72 degree(s)	4000 K	>80	182
910505105913	RC455B 40S/UE 840 DLO L1200 W100 B30	72 degree(s)	4000 K	>80	182 lm/W		-	4000 K	>80	143
					910505105918	RC455X 40S/BU840 DLO W3W2 L1722 W150 B30	72 degree(s)	4000 K	>80	143
910505103924	RC455X 36S/940 DLO U4 W3 L1722 W200 B40	-	4000 K	>90	153 lm/W		-	4000 K	>80	143

# TrueBlend Recessed

Order Code	Full Product Name	Beam angle of light source	Correlated Color Temperature (Nom)	Color rendering index (CRI)	Order Code	Full Product Name	Beam angle of light source	Correlated Color Temperature (Nom)	Color rendering index (CRI)	Lum. Effic. (rate)
910505103973	RC453B 42S/940 DLO 9010 U4 L1200 W300B30	-	4000 K	>90	910505103972	RC453B 28S/840 DLO 9010 ELP3L1200W300B30	-	4000 K	>80	119
910505103981	RC453B 40S/TW9 DLO U4 L1200 W300 B30	-	Tunable white 2700-6500 K	>90	910505103977	RC453B 28S/840 DLO L1195 W298 B30	-	4000 K	>80	124
					910505105907	RC453B 28S/840 DLO L1200W300B30 SC	72 degree(s)	4000 K	>80	152
					910505105908	RC453B 40S/UE840 DLO	72 degree(s)	4000 K	>80	182
910505105909	RC453B 42S/940 DLO9010U4 L1200W300B30 SC	72 degree(s)	4000 K	>90	162 lm/W	L1200W300B30 SC	72 degree(s)	4000 K	>80	180
910505105915	RC453B 42S/UE840 DLO9010 U4 L1200W300B30	72 degree(s)	4000 K	>80	183 lm/W	B30	72 degree(s)	4000 K	>80	143
910505103984	RC453X 28S/840 DLO L1195 W298 B30	-	4000 K	>80	161 lm/W	L1200W300B30	72 degree(s)	4000 K	>80	120
910505103980	RC453B 28S/UE840 MXO9010ELP3L1200W150B30	-	4000 K	>80	910505103961	RC455B 36S/940 MCW-M L1200 W100 B40	-	4000 K	>90	120
910505103982	RC453B 28S/UE840 MXO L1200 W150 B30	-	4000 K	>80	910505103963	RC455B 40S/940 MCW-M L1200 W100 B40	-	4000 K	>90	119
910505103941	RC455B 28S/940 MLO L1200 W100 B40	-	4000 K	>90	910505103906	RC455B 36S/940 MCW-M L1200W100B40 SC	72 degree(s)	4000 K	>90	120
910505103942	RC455B 36S/940 MLO L1200 W100 B40	-	4000 K	>90	95 lm/W	L1200W100B40 SC	72 degree(s)	4000 K	>90	121
910505103943	RC455B 36S/940 MLO L1200 W125 B40	-	4000 K	>90	910505103968	RC455B 40S/940MCW-M U4W3 L1722 W150 B40	-	4000 K	>90	147
910505103944	RC455B 36S/940 MLO L1200 W150 B40	-	4000 K	>90	100 lm/W	W150 B40	-	4000 K	>90	147
910505103945	RC455B 40S/940 MLO L1200 W100 B40	-	4000 K	>90	910505103916	RC455X 36S/940 DLO U4 W3 L1722 W100 B30	-	4000 K	>90	147
910505103946	RC455B 48S/940 MLO L1495 W100 B40	-	4000 K	>90	96 lm/W	W100 B30	-	4000 K	>90	147
910505103947	RC455B 28S/TW9 MLO L1200 W100 B40	-	Tunable white 2700-6500 K	>90	910505103920	RC455X 40S/TW9 DLO U4 W3 L1722 W100 B30	-	Tunable white 2700-6500 K	>90	119
910505105903	RC455B 28S/940 MLO L1200 W100 B40 SC	72 degree(s)	4000 K	>90	910505103923	RC455X 36S/940 DLOU5 9016W3 L1722W185B40	-	4000 K	>90	153
910505105904	RC455B 40S/940 MLO L1200 W100 B40 SC	72 degree(s)	4000 K	>90	910505103931	RC455X 36S/930 DLO U4 W3 L1495 W100 B30	-	3000 K	>90	150
910505105917	RC455B 40S/BU840 MLO L1200 W100 B40	72 degree(s)	4000 K	>80	910505103975	RC453B 36S/940 DLO U5 L1200 W300 B30	-	4000 K	>90	160
910505103971	RC453B 28S/840 DLO L1200 W300 B30	-	4000 K	>80	161 lm/W					

## Light Technical (2/2)

Order Code	Full Product Name	Luminous Flux	Optic type	Upward light output ratio	Order Code	Full Product Name	Luminous Flux	Optic type	Upward light output ratio
910505103952	RC455B 36S/940 MXO U4 L1200 W100 B40	3,600 lm	Wide beam	0	910505103950	RC455B 36S/940 MLO U4 W3 L1722 W100 B40	3,600 lm	Wide beam	0
910505103958	RC455B 40S/TW9 MXO U4 L1200 W100 B40	4,000 lm	Wide beam	0				office compliant	
910505103960	RC455B 40S/940 MXO ELP3 W6L1722W150B40WT	4,000 lm	Wide beam	0	910505103974	RC453B42S/940DLO9010U4ELW3W4L1200W300B30	4,200 lm	Wide beam	0
910505103949	RC455B 28S/TW9 MLO U4 L1720 W124 B40	2,800 lm	Wide beam office compliant	0				office compliant	
					910505103976	RC453B 36S/940 DLO9010U4ELW3L1200W300B30	3,600 lm	Wide beam	0

## TrueBlend Recessed

Order Code	Full Product Name	Luminous Flux	Optic type	Upward light output ratio	Order Code	Full Product Name	Luminous Flux	Optic type	Upward light output ratio
			office compliant		910505105913	RC455B 40S/UE 840 DLO L1200 W100 B30	4,000 lm	Wide beam office compliant	-
910505103957	RC455B 48S/940 MXO L1495 W100 B40	4,800 lm	Wide beam	0					
910505103959	RC455B 28S/TWBW MCW-M U4 L1200 W100 B40	2,800 lm	Reflector	0	910505103924	RC455X 36S/940 DLO U4 W3 L1722 W200 B40	3,600 lm	Wide beam office compliant	0
910505103965	RC455B 36S/940 MCW-M U4 L1200 W100 B40	3,600 lm	Reflector	0					
910505103978	RC453B 28S/UE840 MXO 9010 L1200 W300 B30	2,800 lm	Wide beam	0	910505105911	RC455X 36S/UE840 DLO U4 W3 L1722W200B40	3,600 lm	Wide beam office compliant	-
910505103979	RC453B 28S/UE840MXO9010ELP3 L1200W300B30	2,800 lm	Wide beam	0					
910505103951	RC455B 36S/940 MXO L1200 W100 B40	3,600 lm	Wide beam	0	910505103936	RC455B 36S/940 DLO 9010U4W3 L1722W150B30	3,600 lm	Wide beam office compliant	0
910505103953	RC455B 40S/940 MXO L1200 W100 B40	4,000 lm	Wide beam	0					
910505103954	RC455B 36S/940 MXO L1200 W125 B40	3,600 lm	Wide beam	0	910505103985	RC453X 28S/UE840MXO9010 U4W3L1200W150B30	2,800 lm	Wide beam	0
910505103955	RC455B 36S/940 MXO L1200 W150 B40	3,600 lm	Wide beam	0	910505103921	RC455X 28S/TWBW MCB-M U4 W3 L1722W100B30	2,800 lm	Reflector	0
910505103956	RC455B 28S/940 MXO L1200 W150 B40	2,800 lm	Wide beam	0	910505103935	RC455X 36S/940 MCB-M U4 W3 L1722 W100B30	3,600 lm	Reflector	0
910505105905	RC455B 40S/940 MXO L1200 W100 B40 SC	4,000 lm	Wide beam	-	910505103967	RC455B 40S/940 MCB-M W3W2 L1722 W150 B30	4,000 lm	Reflector	0
910505103937	RC455B 40S/940 DLO U4 W3 L1722 W100 B30	4,000 lm	Wide beam office compliant	0	910505103948	RC455B 28S/TW9 MLO U4 L1200 W100 B40	2,800 lm	Wide beam office compliant	0
910505103940	RC455B 36S/940 DLO L1200 W100 B30	3,600 lm	Wide beam office compliant	0	910505103918	RC455X 36S/940 DLO W5 L1722 W185 B30 WT	3,600 lm	Wide beam office compliant	0
910505103934	RC455X 36S/940 MCW-M U4 W3 L1722 W100B30	3,600 lm	Reflector	0	910505103930	RC455X 40S/940 DLO W3W2 L1497 W185 B30	4,000 lm	Wide beam office compliant	0
910505105902	RC455B 36S/940 MCW-M U4W3L1722W100B30SC	3,600 lm	Reflector	-					
910505103926	RC455X 40S/940 DLO W3W2 L1700 W100 B30	4,000 lm	Wide beam office compliant	0	910505103932	RC455X 36S/940 MLO W5 L1722 W185 B30 WT	3,600 lm	Wide beam office compliant	0
910505103927	RC455X 40S/940 DLO W3W2 L1497 W150 B30	4,000 lm	Wide beam office compliant	0	910505105912	RC455B 36S/UE840 DLO W3W2 L1722 W185 B30	3,600 lm	Wide beam office compliant	-
910505105901	RC455X 40S/940 DLO W3W2 L1497W150B30 SC	4,000 lm	Wide beam office compliant	-	910505103962	RC455B 36S/940 MCB-M L1200 W100 B40	3,600 lm	Reflector	0
					910505103964	RC455B 40S/940 MCB-M L1200 W100 B40	4,000 lm	Reflector	0

## TrueBlend Recessed

Order Code	Full Product Name	Luminous Flux	Optic type	Upward light output ratio	Order Code	Full Product Name	Luminous Flux	Optic type	Upward light output ratio
910505103966	RC455B 36S/940 MCB-M U4 L1200 W100 B40	3,600 lm	Reflector	0				office compliant	
910505103938	RC455B 40S/940 DLO W3W2 L1722 W150 B30	4,000 lm	Wide beam office compliant	0	910505103984	RC453X 28S/840 DLO L1195 W298 B30	2,800 lm	Wide beam office compliant	0
910505103939	RC455B 36S/940 DLO W3W2 L1722 W185 B30	3,600 lm	Wide beam office compliant	0	910505103980	RC453B 28S/UE840 MXO9010ELP3L1200W150B30	2,800 lm	Wide beam	0
910505103917	RC455X 40S/940 DLO W3W2 L1722 W150 B30	4,000 lm	Wide beam office compliant	0	910505103982	RC453B 28S/UE840 MXO L1200 W150 B30	2,800 lm	Wide beam	0
910505103919	RC455X 40S/940 DLO W3W2 L1722 W150 B40	4,000 lm	Wide beam office compliant	0	910505103941	RC455B 28S/940 MLO L1200 W100 B40	2,800 lm	Wide beam office compliant	0
910505103922	RC455X 40S/930 DLO W3W2 L1722 W150 B30	4,000 lm	Wide beam office compliant	0	910505103942	RC455B 36S/940 MLO L1200 W100 B40	3,600 lm	Wide beam office compliant	0
910505103925	RC455X 36S/940 DLO W5 L1700 W150 B30 WT	3,600 lm	Wide beam office compliant	0	910505103943	RC455B 36S/940 MLO L1200 W125 B40	3,600 lm	Wide beam office compliant	0
910505105910	RC455X 40S/UE840 DLO W3W2 L1722 W150 B40	4,000 lm	Wide beam office compliant	-	910505103944	RC455B 36S/940 MLO L1200 W150 B40	3,600 lm	Wide beam office compliant	0
910505105918	RC455X 40S/BU840 DLO W3W2 L1722 W150 B30	4,000 lm	Wide beam office compliant	-	910505103945	RC455B 40S/940 MLO L1200 W100 B40	4,000 lm	Wide beam office compliant	0
910505103973	RC453B 42S/940 DLO 9010 U4 L1200 W300B30	4,200 lm	Wide beam office compliant	0	910505103946	RC455B 48S/940 MLO L1495 W100 B40	4,800 lm	Wide beam office compliant	0
910505103981	RC453B 40S/TW9 DLO U4 L1200 W300 B30	4,000 lm	Wide beam office compliant	0	910505103947	RC455B 28S/TW9 MLO L1200 W100 B40	2,800 lm	Wide beam office compliant	0
910505105909	RC453B 42S/940 DLO9010U4 L1200W300B30 SC	4,200 lm	Wide beam office compliant	-	910505105903	RC455B 28S/940 MLO L1200 W100 B40 SC	2,800 lm	Wide beam office compliant	-
910505105915	RC453B 42S/UE840 DLO9010 U4 L1200W300B30	4,200 lm	Wide beam	-	910505105904	RC455B 40S/940 MLO L1200 W100 B40 SC	4,000 lm	Wide beam office compliant	-
					910505105917	RC455B 40S/BU840 MLO L1200 W100 B40	4,000 lm	Wide beam	-

## TrueBlend Recessed

Order Code	Full Product Name	Luminous Flux	Optic type	Upward light output ratio	Order Code	Full Product Name	Luminous Flux	Optic type	Upward light output ratio
			office compliant					office compliant	
910505103971	RC453B 28S/840 DLO L1200 W300 B30	2,800 lm	Wide beam office compliant	0	910505103961	RC455B 36S/940 MCW-M L1200 W100 B40	3,600 lm	Reflector	0
910505103972	RC453B 28S/840 DLO 9010 ELP3L1200W300B30	2,800 lm	Wide beam office compliant	0	910505103963	RC455B 40S/940 MCW-M L1200 W100 B40	4,000 lm	Reflector	0
910505103977	RC453B 28S/840 DLO L1195 W298 B30	2,800 lm	Wide beam office compliant	0	910505105906	RC455B 36S/940 MCW-M L1200W100B40 SC	3,600 lm	Reflector	-
910505105907	RC453B 28S/840 DLO L1200W300B30 SC	2,800 lm	Wide beam office compliant	-	910505103968	RC455B 40S/940MCW-M U4W3 L1722 W150 B40	4,000 lm	Reflector	0
910505105908	RC453B 40S/UE840 DLO L1200W300B30 SC	4,000 lm	Wide beam office compliant	-	910505103916	RC455X 36S/940 DLO U4 W3 L1722 W100 B30	3,600 lm	Wide beam office compliant	0
910505105914	RC453B 28S/UE840 DLO L1200 W300 B30	2,800 lm	Wide beam office compliant	-	910505103920	RC455X 40S/TW9 DLO U4 W3 L1722 W100 B30	4,000 lm	Wide beam office compliant	0
910505105916	RC453B 28S/BU840 DLO L1200W300B30	2,800 lm	Wide beam	-	910505103923	RC455X 36S/940 DLOU5 9016W3 L1722W185B40	3,600 lm	Wide beam office compliant	0
					910505103931	RC455X 36S/930 DLO U4 W3 L1495 W100 B30	3,600 lm	Wide beam office compliant	0
					910505103975	RC453B 36S/940 DLO U5 L1200 W300 B30	3,600 lm	Wide beam office compliant	0

## Operating and Electrical

Order Code	Full Product Name	Power Consumption	Suitable for random switching	Order Code	Full Product Name	Power Consumption	Suitable for random switching
910505103952	RC455B 36S/940 MXO U4 L1200 W100 B40	29.5 W	Yes	910505103957	RC455B 48S/940 MXO L1495 W100 B40	40.5 W	No
910505103958	RC455B 40S/TW9 MXO U4 L1200 W100 B40	44.5 W	Yes	910505103959	RC455B 28S/TWBU MCW-M U4 L1200 W100 B40	37.5 W	Yes
910505103960	RC455B 40S/940 MXO ELP3 W6L1722W150B40WT	37 W	No	910505103965	RC455B 36S/940 MCW-M U4 L1200 W100 B40	29.5 W	Yes
910505103949	RC455B 28S/TW9 MLO U4 L1720 W124 B40	33 W	Yes	910505103978	RC453B 28S/UE840 MXO 9010 L1200 W300 B30	19.4 W	No
910505103950	RC455B 36S/940 MLO U4 W3 L1722 W100 B40	38 W	Yes	910505103979	RC453B 28S/UE840MXO9010ELP3 L1200W300B30	25.5 W	No
910505103974	RC453B42S/ 940DLO9010U4ELW3W4L1200W300B30	32 W	Yes	910505103951	RC455B 36S/940 MXO L1200 W100 B40	30 W	No
910505103976	RC453B 36S/940 DLO9010U4ELW3L1200W300B30	28.5 W	Yes	910505103953	RC455B 40S/940 MXO L1200 W100 B40	34 W	No
				910505103954	RC455B 36S/940 MXO L1200 W125 B40	29 W	No

## TrueBlend Recessed

Order Code	Full Product Name	Power Consumption	Suitable for random switching
910505103955	RC455B 36S/940 MXO L1200 W150 B40	28 W	No
910505103956	RC455B 28S/940 MXO L1200 W150 B40	22 W	No
910505105905	RC455B 40S/940 MXO L1200 W100 B40 SC	35 W	No
910505103937	RC455B 40S/940 DLO U4 W3 L1722 W100 B30	26 W	Yes
910505103940	RC455B 36S/940 DLO L1200 W100 B30	24 W	No
910505103934	RC455X 36S/940 MCW-M U4 W3 L1722 W100B30	29.5 W	Yes
910505105902	RC455B 36S/940 MCW-M U4W3L1722W100B30SC	29.5 W	Yes
910505103926	RC455X 40S/940 DLO W3W2 L1700 W100 B30	28.5 W	No
910505103927	RC455X 40S/940 DLO W3W2 L1497 W150 B30	26.5 W	No
910505105901	RC455X 40S/940 DLO W3W2 L1497W150B30 SC	26.6 W	No
910505105913	RC455B 40S/UE 840 DLO L1200 W100 B30	22 W	No
910505103924	RC455X 36S/940 DLO U4 W3 L1722 W200 B40	23.5 W	Yes
910505105911	RC455X 36S/UE840 DLO U4 W3 L1722W200B40	19.8 W	Yes
910505103936	RC455B 36S/940 DLO 9010U4W3 L1722W150B30	23.5 W	Yes
910505103985	RC453X 28S/UE840MXO9010 U4W3L1200W150B30	25 W	Yes
910505103921	RC455X 28S/TWBU MCB-M U4 W3 L1722W100B30	38.5 W	Yes
910505103935	RC455X 36S/940 MCB-M U4 W3 L1722 W100B30	33.5 W	Yes
910505103967	RC455B 40S/940 MCB-M W3W2 L1722 W150 B30	38 W	No
910505103948	RC455B 28S/TW9 MLO U4 L1200 W100 B40	33 W	Yes
910505103918	RC455X 36S/940 DLO W5 L1722 W185 B30 WT	24 W	No
910505103930	RC455X 40S/940 DLO W3W2 L1497 W185 B30	26.5 W	No
910505103932	RC455X 36S/940 MLO W5 L1722 W185 B30 WT	36 W	No
910505105912	RC455B 36S/UE840 DLO W3W2 L1722 W185 B30	19.8 W	No
910505103962	RC455B 36S/940 MCB-M L1200 W100 B40	34 W	No
910505103964	RC455B 40S/940 MCB-M L1200 W100 B40	38.5 W	No
910505103966	RC455B 36S/940 MCB-M U4 L1200 W100 B40	33.5 W	Yes
910505103938	RC455B 40S/940 DLO W3W2 L1722 W150 B30	26.5 W	No
910505103939	RC455B 36S/940 DLO W3W2 L1722 W185 B30	24 W	No

Order Code	Full Product Name	Power Consumption	Suitable for random switching
910505103917	RC455X 40S/940 DLO W3W2 L1722 W150 B30	26.5 W	No
910505103919	RC455X 40S/940 DLO W3W2 L1722 W150 B40	26.5 W	No
910505103922	RC455X 40S/930 DLO W3W2 L1722 W150 B30	26.5 W	No
910505103925	RC455X 36S/940 DLO W5 L1700 W150 B30 WT	24 W	No
910505105910	RC455X 40S/UE840 DLO W3W2 L1722 W150 B40	22 W	No
910505105918	RC455X 40S/BU840 DLO W3W2 L1722 W150 B30	28 W	No
910505103973	RC453B 42S/940 DLO 9010 U4 L1200 W300B30	26 W	Yes
910505103981	RC453B 40S/TW9 DLO U4 L1200 W300 B30	36.5 W	Yes
910505105909	RC453B 42S/940 DLO9010U4 L1200W300B30 SC	26 W	Yes
910505105915	RC453B 42S/UE840 DLO9010 U4 L1200W300B30	23.1 W	Yes
910505103984	RC453X 28S/840 DLO L1195 W298 B30	17.4 W	No
910505103980	RC453B 28S/UE840 MXO9010ELP3L1200W150B30	25.5 W	No
910505103982	RC453B 28S/UE840 MXO L1200 W150 B30	19.4 W	No
910505103941	RC455B 28S/940 MLO L1200 W100 B40	29 W	No
910505103942	RC455B 36S/940 MLO L1200 W100 B40	38 W	No
910505103943	RC455B 36S/940 MLO L1200 W125 B40	36 W	No
910505103944	RC455B 36S/940 MLO L1200 W150 B40	36 W	No
910505103945	RC455B 40S/940 MLO L1200 W100 B40	42.5 W	No
910505103946	RC455B 48S/940 MLO L1495 W100 B40	50 W	No
910505103947	RC455B 28S/TW9 MLO L1200 W100 B40	33 W	No
910505105903	RC455B 28S/940 MLO L1200 W100 B40 SC	29 W	No
910505105904	RC455B 40S/940 MLO L1200 W100 B40 SC	42.5 W	No
910505105917	RC455B 40S/BU840 MLO L1200 W100 B40	39.9 W	No
910505103971	RC453B 28S/840 DLO L1200 W300 B30	17.4 W	No
910505103972	RC453B 28S/840 DLO 9010 ELP3L1200W300B30	23.5 W	No
910505103977	RC453B 28S/840 DLO L1195 W298 B30	22.5 W	No
910505105907	RC453B 28S/840 DLO L1200W300B30 SC	18.4 W	No
910505105908	RC453B 40S/UE840 DLO L1200W300B30 SC	22 W	No
910505105914	RC453B 28S/UE840 DLO L1200 W300 B30	15.4 W	No
910505105916	RC453B 28S/BU840 DLO L1200W300B30	19.6 W	No
910505103961	RC455B 36S/940 MCW-M L1200 W100 B40	30 W	No
910505103963	RC455B 40S/940 MCW-M L1200 W100 B40	33.5 W	No
910505105906	RC455B 36S/940 MCW-M L1200W100B40 SC	30 W	No
910505103968	RC455B 40S/940MCW-M U4W3 L1722 W150 B40	33 W	Yes

## TrueBlend Recessed

Order Code	Full Product Name	Power Consumption	Suitable for random switching
910505103916	RC455X 36S/940 DLO U4 W3 L1722 W100 B30	24.5 W	Yes
910505103920	RC455X 40S/TW9 DLO U4 W3 L1722 W100 B30	33.5 W	Yes
910505103923	RC455X 36S/940 DLOU5 9016W3 L1722W185B40	23.5 W	Yes

Order Code	Full Product Name	Power Consumption	Suitable for random switching
910505103931	RC455X 36S/930 DLO U4 W3 L1495 W100 B30	24 W	Yes
910505103975	RC453B 36S/940 DLO U5 L1200 W300 B30	22.5 W	Yes

### Controls and Dimming

Order Code	Full Product Name	Embedded control
910505103952	RC455B 36S/940 MXO U4 L1200 W100 B40	Upgradable sensor slot with SC200 sensor
910505103958	RC455B 40S/TW9 MXO U4 L1200 W100 B40	Upgradable sensor slot with SC200 sensor
910505103960	RC455B 40S/940 MXO ELP3 W6L1722W150B40WT	-
910505103949	RC455B 28S/TW9 MLO U4 L1720 W124 B40	Upgradable sensor slot with SC200 sensor
910505103950	RC455B 36S/940 MLO U4 W3 L1722 W100 B40	Upgradable sensor slot with SC200 sensor
910505103974	RC453B42S/ 940DLO9010U4ELW3W4L1200W300B30	Upgradable sensor slot with SC200 sensor
910505103976	RC453B 36S/940 DLO9010U4ELW3L1200W300B30	Upgradable sensor slot with SC200 sensor
910505103957	RC455B 48S/940 MXO L1495 W100 B40	-
910505103959	RC455B 28S/TWBU MCW-M U4 L1200 W100 B40	Upgradable sensor slot with SC200 sensor
910505103965	RC455B 36S/940 MCW-M U4 L1200 W100 B40	Upgradable sensor slot with SC200 sensor
910505103978	RC453B 28S/UE840 MXO 9010 L1200 W300 B30	-
910505103979	RC453B 28S/UE840MXO9010ELP3 L1200W300B30	-
910505103951	RC455B 36S/940 MXO L1200 W100 B40	-
910505103953	RC455B 40S/940 MXO L1200 W100 B40	-
910505103954	RC455B 36S/940 MXO L1200 W125 B40	-
910505103955	RC455B 36S/940 MXO L1200 W150 B40	-
910505103956	RC455B 28S/940 MXO L1200 W150 B40	-
910505105905	RC455B 40S/940 MXO L1200 W100 B40 SC	-
910505103937	RC455B 40S/940 DLO U4 W3 L1722 W100 B30	Upgradable sensor slot with SC200 sensor
910505103940	RC455B 36S/940 DLO L1200 W100 B30	-

Order Code	Full Product Name	Embedded control
910505103934	RC455X 36S/940 MCW-M U4 W3 L1722 W100B30	Upgradable sensor slot with SC200 sensor
910505105902	RC455B 36S/940 MCW-M U4W3L1722W100B30SC	Upgradable sensor slot with SC200 sensor
910505103926	RC455X 40S/940 DLO W3W2 L1700 W100 B30	-
910505103927	RC455X 40S/940 DLO W3W2 L1497 W150 B30	-
910505105901	RC455X 40S/940 DLO W3W2 L1497W150B30 SC	-
910505105913	RC455B 40S/UE 840 DLO L1200 W100 B30	-
910505103924	RC455X 36S/940 DLO U4 W3 L1722 W200 B40	Upgradable sensor slot with SC200 sensor
910505105911	RC455X 36S/UE840 DLO U4 W3 L1722W200B40	Upgradable sensor slot with SC200 sensor
910505103936	RC455B 36S/940 DLO 9010U4W3 L1722W150B30	Upgradable sensor slot with SC200 sensor
910505103985	RC453X 28S/UE840MXO9010 U4W3L1200W150B30	Upgradable sensor slot with SC200 sensor
910505103921	RC455X 28S/TWBU MCB-M U4 W3 L1722W100B30	Upgradable sensor slot with SC200 sensor
910505103935	RC455X 36S/940 MCB-M U4 W3 L1722 W100B30	Upgradable sensor slot with SC200 sensor
910505103967	RC455B 40S/940 MCB-M W3W2 L1722 W150 B30	-
910505103948	RC455B 28S/TW9 MLO U4 L1200 W100 B40	Upgradable sensor slot with SC200 sensor
910505103918	RC455X 36S/940 DLO W5 L1722 W185 B30 WT	-
910505103930	RC455X 40S/940 DLO W3W2 L1497 W185 B30	-
910505103932	RC455X 36S/940 MLO W5 L1722 W185 B30 WT	-
910505105912	RC455B 36S/UE840 DLO W3W2 L1722 W185 B30	-
910505103962	RC455B 36S/940 MCB-M L1200 W100 B40	-
910505103964	RC455B 40S/940 MCB-M L1200 W100 B40	-

## TrueBlend Recessed

Order Code	Full Product Name	Embedded control
910505103966	RC455B 36S/940 MCB-M U4 L1200 W100 B40	Upgradable sensor slot with SC200 sensor
910505103938	RC455B 40S/940 DLO W3W2 L1722 W150 B30	-
910505103939	RC455B 36S/940 DLO W3W2 L1722 W185 B30	-
910505103917	RC455X 40S/940 DLO W3W2 L1722 W150 B30	-
910505103919	RC455X 40S/940 DLO W3W2 L1722 W150 B40	-
910505103922	RC455X 40S/930 DLO W3W2 L1722 W150 B30	-
910505103925	RC455X 36S/940 DLO W5 L1700 W150 B30 WT	-
910505105910	RC455X 40S/UE840 DLO W3W2 L1722 W150 B40	-
910505105918	RC455X 40S/BU840 DLO W3W2 L1722 W150 B30	-
910505103973	RC453B 42S/940 DLO 9010 U4 L1200 W300B30	Upgradable sensor slot with SC200 sensor
910505103981	RC453B 40S/TW9 DLO U4 L1200 W300 B30	Upgradable sensor slot with SC200 sensor
910505105909	RC453B 42S/940 DLO9010U4 L1200W300B30 SC	Upgradable sensor slot with SC200 sensor
910505105915	RC453B 42S/UE840 DLO9010 U4 L1200W300B30	Upgradable sensor slot with SC200 sensor
910505103984	RC453X 28S/840 DLO L1195 W298 B30	-
910505103980	RC453B 28S/UE840 MXO9010ELP3L1200W150B30	-
910505103982	RC453B 28S/UE840 MXO L1200 W150 B30	-
910505103941	RC455B 28S/940 MLO L1200 W100 B40	-
910505103942	RC455B 36S/940 MLO L1200 W100 B40	-
910505103943	RC455B 36S/940 MLO L1200 W125 B40	-
910505103944	RC455B 36S/940 MLO L1200 W150 B40	-
910505103945	RC455B 40S/940 MLO L1200 W100 B40	-
910505103946	RC455B 48S/940 MLO L1495 W100 B40	-

### Mechanical and Housing

Order Code	Full Product Name	Optical cover type
910505103952	RC455B 36S/940 MXO U4 L1200 W100 B40	Micro Hexagonal Optic
910505103958	RC455B 40S/TW9 MXO U4 L1200 W100 B40	Micro Hexagonal Optic
910505103960	RC455B 40S/940 MXO ELP3 W6L1722W150B40WT	Micro Hexagonal Optic
910505103949	RC455B 28S/TW9 MLO U4 L1720 W124 B40	Micro-lens optic
910505103950	RC455B 36S/940 MLO U4 W3 L1722 W100 B40	Micro-lens optic

Order Code	Full Product Name	Embedded control
910505103947	RC455B 28S/TW9 MLO L1200 W100 B40	-
910505105903	RC455B 28S/940 MLO L1200 W100 B40 SC	-
910505105904	RC455B 40S/940 MLO L1200 W100 B40 SC	-
910505105917	RC455B 40S/BU840 MLO L1200 W100 B40	-
910505103971	RC453B 28S/840 DLO L1200 W300 B30	-
910505103972	RC453B 28S/840 DLO 9010 ELP3L1200W300B30	-
910505103977	RC453B 28S/840 DLO L1195 W298 B30	-
910505105907	RC453B 28S/840 DLO L1200W300B30 SC	-
910505105908	RC453B 40S/UE840 DLO L1200W300B30 SC	-
910505105914	RC453B 28S/UE840 DLO L1200 W300 B30	-
910505105916	RC453B 28S/BU840 DLO L1200W300B30	-
910505103961	RC455B 36S/940 MCW-M L1200 W100 B40	-
910505103963	RC455B 40S/940 MCW-M L1200 W100 B40	-
910505105906	RC455B 36S/940 MCW-M L1200W100B40 SC	-
910505103968	RC455B 40S/940MCW-M U4W3 L1722 W150 B40	Upgradable sensor slot with SC200 sensor
910505103916	RC455X 36S/940 DLO U4 W3 L1722 W100 B30	Upgradable sensor slot with SC200 sensor
910505103920	RC455X 40S/TW9 DLO U4 W3 L1722 W100 B30	Upgradable sensor slot with SC200 sensor
910505103923	RC455X 36S/940 DLOU5 9016W3 L1722W185B40	Interact SC1500 Multi-sensor bundle
910505103931	RC455X 36S/930 DLO U4 W3 L1495 W100 B30	Upgradable sensor slot with SC200 sensor
910505103975	RC453B 36S/940 DLO U5 L1200 W300 B30	Interact SC1500 Multi-sensor bundle

Order Code	Full Product Name	Optical cover type
910505103974	RC453B42S/940DLO9010U4ELW3W4L1200W300B30	Acrylic bowl/ cover frosted
910505103976	RC453B 36S/940 DLO9010U4ELW3L1200W300B30	Acrylic bowl/ cover frosted
910505103957	RC455B 48S/940 MXO L1495 W100 B40	Micro Hexagonal Optic
910505103959	RC455B 28S/TWBU MCW-M U4 L1200 W100 B40	Micro Hexagonal Optic
910505103965	RC455B 36S/940 MCW-M U4 L1200 W100 B40	-
910505103978	RC453B 28S/UE840 MXO 9010 L1200 W300 B30	Micro Hexagonal Optic

## TrueBlend Recessed

Order Code	Full Product Name	Optical cover type
910505103979	RC453B 28S/UE840MXO9010ELP3 L1200W300B30	Micro Hexagonal Optic
910505103951	RC455B 36S/940 MXO L1200 W100 B40	Micro Hexagonal Optic
910505103953	RC455B 40S/940 MXO L1200 W100 B40	Micro Hexagonal Optic
910505103954	RC455B 36S/940 MXO L1200 W125 B40	Micro Hexagonal Optic
910505103955	RC455B 36S/940 MXO L1200 W150 B40	Micro Hexagonal Optic
910505103956	RC455B 28S/940 MXO L1200 W150 B40	Micro Hexagonal Optic
910505105905	RC455B 40S/940 MXO L1200 W100 B40 SC	-
910505103937	RC455B 40S/940 DLO U4 W3 L1722 W100 B30	Acrylic bowl/ cover frosted
910505103940	RC455B 36S/940 DLO L1200 W100 B30	Acrylic bowl/ cover frosted
910505103934	RC455X 36S/940 MCW-M U4 W3 L1722 W100B30	-
910505105902	RC455B 36S/940 MCW-M U4W3L1722W100B30SC	-
910505103926	RC455X 40S/940 DLO W3W2 L1700 W100 B30	Acrylic bowl/ cover frosted
910505103927	RC455X 40S/940 DLO W3W2 L1497 W150 B30	Acrylic bowl/ cover frosted
910505105901	RC455X 40S/940 DLO W3W2 L1497W150B30 SC	-
910505105913	RC455B 40S/UE 840 DLO L1200 W100 B30	-
910505103924	RC455X 36S/940 DLO U4 W3 L1722 W200 B40	Acrylic bowl/ cover frosted
910505105911	RC455X 36S/UE840 DLO U4 W3 L1722W200B40	-
910505103936	RC455B 36S/940 DLO 9010U4W3 L1722W150B30	Acrylic bowl/ cover frosted
910505103985	RC453X 28S/UE840MXO9010 U4W3L1200W150B30	Micro Hexagonal Optic
910505103921	RC455X 28S/TWBU MCB-M U4 W3 L1722W100B30	Acrylic bowl/ cover frosted
910505103935	RC455X 36S/940 MCB-M U4 W3 L1722 W100B30	-
910505103967	RC455B 40S/940 MCB-M W3W2 L1722 W150 B30	-
910505103948	RC455B 28S/TW9 MLO U4 L1200 W100 B40	Micro-lens optic
910505103918	RC455X 36S/940 DLO W5 L1722 W185 B30 WT	Acrylic bowl/ cover frosted
910505103930	RC455X 40S/940 DLO W3W2 L1497 W185 B30	Acrylic bowl/ cover frosted

Order Code	Full Product Name	Optical cover type
910505103932	RC455X 36S/940 MLO W5 L1722 W185 B30 WT	Micro Hexagonal Optic
910505105912	RC455B 36S/UE840 DLO W3W2 L1722 W185 B30	-
910505103962	RC455B 36S/940 MCB-M L1200 W100 B40	-
910505103964	RC455B 40S/940 MCB-M L1200 W100 B40	-
910505103966	RC455B 36S/940 MCB-M U4 L1200 W100 B40	-
910505103938	RC455B 40S/940 DLO W3W2 L1722 W150 B30	Acrylic bowl/ cover frosted
910505103939	RC455B 36S/940 DLO W3W2 L1722 W185 B30	Acrylic bowl/ cover frosted
910505103917	RC455X 40S/940 DLO W3W2 L1722 W150 B30	Acrylic bowl/ cover frosted
910505103919	RC455X 40S/940 DLO W3W2 L1722 W150 B40	Acrylic bowl/ cover frosted
910505103922	RC455X 40S/930 DLO W3W2 L1722 W150 B30	Acrylic bowl/ cover frosted
910505103925	RC455X 36S/940 DLO W5 L1700 W150 B30 WT	Acrylic bowl/ cover frosted
910505105910	RC455X 40S/UE840 DLO W3W2 L1722 W150 B40	-
910505105918	RC455X 40S/BU840 DLO W3W2 L1722 W150 B30	-
910505103973	RC453B 42S/940 DLO 9010 U4 L1200 W300B30	Acrylic bowl/ cover frosted
910505103981	RC453B 40S/TW9 DLO U4 L1200 W300 B30	Micro Hexagonal Optic
910505105909	RC453B 42S/940 DLO9010U4 L1200W300B30 SC	-
910505105915	RC453B 42S/UE840 DLO9010 U4 L1200W300B30	-
910505103984	RC453X 28S/840 DLO L1195 W298 B30	Acrylic bowl/ cover frosted
910505103980	RC453B 28S/UE840 MXO9010ELP3L1200W150B30	Micro Hexagonal Optic
910505103982	RC453B 28S/UE840 MXO L1200 W150 B30	Micro Hexagonal Optic
910505103941	RC455B 28S/940 MLO L1200 W100 B40	Micro-lens optic
910505103942	RC455B 36S/940 MLO L1200 W100 B40	Micro-lens optic
910505103943	RC455B 36S/940 MLO L1200 W125 B40	Micro-lens optic
910505103944	RC455B 36S/940 MLO L1200 W150 B40	Micro-lens optic
910505103945	RC455B 40S/940 MLO L1200 W100 B40	Micro-lens optic
910505103946	RC455B 48S/940 MLO L1495 W100 B40	Micro-lens optic
910505103947	RC455B 28S/TW9 MLO L1200 W100 B40	Micro-lens optic
910505105903	RC455B 28S/940 MLO L1200 W100 B40 SC	-

## TrueBlend Recessed

Order Code	Full Product Name	Optical cover type
910505105904	RC455B 40S/940 MLO L1200 W100 B40 SC	-
910505105917	RC455B 40S/BU840 MLO L1200 W100 B40	-
910505103971	RC453B 28S/840 DLO L1200 W300 B30	Acrylic bowl/ cover frosted
910505103972	RC453B 28S/840 DLO 9010 ELP3L1200W300B30	Acrylic bowl/ cover frosted
910505103977	RC453B 28S/840 DLO L1195 W298 B30	Acrylic bowl/ cover frosted
910505105907	RC453B 28S/840 DLO L1200W300B30 SC	-
910505105908	RC453B 40S/UE840 DLO L1200W300B30 SC	-
910505105914	RC453B 28S/UE840 DLO L1200 W300 B30	-
910505105916	RC453B 28S/BU840 DLO L1200W300B30	-
910505103961	RC455B 36S/940 MCW-M L1200 W100 B40	-

Order Code	Full Product Name	Optical cover type
910505103963	RC455B 40S/940 MCW-M L1200 W100 B40	-
910505105906	RC455B 36S/940 MCW-M L1200W100B40 SC	-
910505103968	RC455B 40S/940MCW-M U4W3 L1722 W150 B40	-
910505103916	RC455X 36S/940 DLO U4 W3 L1722 W100 B30	Acrylic bowl/ cover frosted
910505103920	RC455X 40S/TW9 DLO U4 W3 L1722 W100 B30	Acrylic bowl/ cover frosted
910505103923	RC455X 36S/940 DLOU5 9016W3 L1722W185B40	Acrylic bowl/ cover frosted
910505103931	RC455X 36S/930 DLO U4 W3 L1495 W100 B30	Acrylic bowl/ cover frosted
910505103975	RC453B 36S/940 DLO U5 L1200 W300 B30	Acrylic bowl/ cover frosted

## Emergency Operation

Order Code	Full Product Name	Emergency lighting	Emergency flux	Power consumption during Central emergency mode	Order Code	Full Product Name	Emergency lighting	Emergency flux	Power consumption during Central DC emergency mode
910505103952	RC455B 36S/940 MXO U4 L1200 W100 B40	DC operated central emergency lighting	-	-	-	-	central emergency lighting	-	-
910505103958	RC455B 40S/TW9 MXO U4 L1200 W100 B40	DC operated central emergency lighting	-	-	-	-	central emergency lighting	-	-
910505103960	RC455B 40S/940 MXO ELP3 W6L1722W150B40WT	Emergency lighting 3 hours duration Pro version	405 lm	6 W	3 hour(s)	-	central emergency lighting	-	-
910505103949	RC455B 28S/TW9 MLO U4 L1720 W124 B40	DC operated central emergency lighting	-	-	-	-	central emergency lighting	-	-
910505103950	RC455B 36S/940 MLO U4 W3 L1722 W100 B40	DC operated central emergency lighting	-	-	-	-	central emergency lighting	-	-
910505103974	RC453B42S/ 940DLO9010U4ELW3W4L1200W300B30	DC operated	520 lm	6 W	3 hour(s)	-	central	-	-
910505103976	RC453B 36S/940 DLO9010U4ELW3L1200W300B30	DC operated central emergency lighting	-	-	-	-	DC operated central emergency lighting	520 lm	6 W
910505103957	RC455B 48S/940 MXO L1495 W100 B40	DC operated central emergency lighting	-	-	-	-	DC operated central emergency lighting	-	-
910505103959	RC455B 28S/TWBU MCW-M U4 L1200 W100 B40	DC operated central emergency lighting	-	-	-	-	DC operated central emergency lighting	-	-
910505103965	RC455B 36S/940 MCW-M U4 L1200 W100 B40	DC operated central emergency lighting	-	-	-	-	DC operated central emergency lighting	-	-
910505103978	RC453B 28S/UE840 MXO 9010 L1200 W300 B30	DC operated	-	-	-	-	DC operated	-	-

# TrueBlend Recessed

Order Code	Full Product Name	Emergency lighting	Emergency flux	Emergency mode	Power consumption during Central	Order Code	Full Product Name	Emergency lighting	Emergency flux	Emergency mode	Power consumption during Central DC
910505103979	RC453B 28S/UE840MXO9010ELP3 L1200W300B30	Emergency lighting 3 hours duration Pro version	405 lm	6 W	3103979	RC455X 36S/940 MCW-M U4 W3 L1722 W100B30	DC operated central emergency lighting	-	-	-	-
910505103951	RC455B 36S/940 MXO L1200 W100 B40	DC operated central emergency lighting	-	-	910505105902	RC455B 36S/940 MCW-M U4W3L1722W100B30SC	DC operated central emergency lighting	-	-	-	-
910505103953	RC455B 40S/940 MXO L1200 W100 B40	DC operated central emergency lighting	-	-	910505103926	RC455X 40S/940 DLO W3W2 L1700 W100 B30	DC operated central emergency lighting	-	-	-	-
910505103954	RC455B 36S/940 MXO L1200 W125 B40	DC operated central emergency lighting	-	-	910505103927	RC455X 40S/940 DLO W3W2 L1497 W150 B30	DC operated central emergency lighting	-	-	-	-
910505103955	RC455B 36S/940 MXO L1200 W150 B40	DC operated central emergency lighting	-	-	910505105901	RC455X 40S/940 DLO W3W2 L1497W150B30 SC	DC operated central emergency lighting	-	-	-	-
910505103956	RC455B 28S/940 MXO L1200 W150 B40	DC operated central emergency lighting	-	-	910505105913	RC455B 40S/UE 840 DLO L1200 W100 B30	DC operated central emergency lighting	-	-	-	-
910505105905	RC455B 40S/940 MXO L1200 W100 B40 SC	DC operated central emergency lighting	-	-	910505103924	RC455X 36S/940 DLO U4 W3 L1722 W200 B40	DC operated central emergency lighting	-	-	-	-
910505103937	RC455B 40S/940 DLO U4 W3 L1722 W100 B30	DC operated central emergency lighting	-	-	910505105911	RC455X 36S/UE840 DLO U4 W3 L1722W200B40	DC operated central emergency lighting	-	-	-	-
910505103940	RC455B 36S/940 DLO L1200 W100 B30	DC operated central	-	-	910505103936	RC455B 36S/940 DLO 9010U4W3 L1722W150B30	DC operated central	-	-	-	-

# TrueBlend Recessed

Order Code	Full Product Name	Emergency lighting	Emergency flux	Power consumption during Central mode	Order Code	Full Product Name	Emergency lighting	Emergency flux	Power consumption during Central mode
910505103985	RC453X 28S/UE840MXO9010 U4W3L1200W150B30	DC operated central emergency lighting	-	-	910505103962	RC455B 36S/940 MCB-M L1200 W100 B40	DC operated central emergency lighting	-	-
910505103921	RC455X 28S/TWBU MCB-M U4 W3 L1722W100B30	DC operated central emergency lighting	-	-	910505103964	RC455B 40S/940 MCB-M L1200 W100 B40	DC operated central emergency lighting	-	-
910505103935	RC455X 36S/940 MCB-M U4 W3 L1722 W100B30	DC operated central emergency lighting	-	-	910505103966	RC455B 36S/940 MCB-M U4 L1200 W100 B40	DC operated central emergency lighting	-	-
910505103967	RC455B 40S/940 MCB-M W3W2 L1722 W150 B30	DC operated central emergency lighting	-	-	910505103938	RC455B 40S/940 DLO W3W2 L1722 W150 B30	DC operated central emergency lighting	-	-
910505103948	RC455B 28S/TW9 MLO U4 L1200 W100 B40	DC operated central emergency lighting	-	-	910505103939	RC455B 36S/940 DLO W3W2 L1722 W185 B30	DC operated central emergency lighting	-	-
910505103918	RC455X 36S/940 DLO W5 L1722 W185 B30 WT	DC operated central emergency lighting	-	-	910505103917	RC455X 40S/940 DLO W3W2 L1722 W150 B30	DC operated central emergency lighting	-	-
910505103930	RC455X 40S/940 DLO W3W2 L1497 W185 B30	DC operated central emergency lighting	-	-	910505103919	RC455X 40S/940 DLO W3W2 L1722 W150 B40	DC operated central emergency lighting	-	-
910505103932	RC455X 36S/940 MLO W5 L1722 W185 B30 WT	DC operated central emergency lighting	-	-	910505103922	RC455X 40S/930 DLO W3W2 L1722 W150 B30	DC operated central emergency lighting	-	-
910505105912	RC455B 36S/UE840 DLO W3W2 L1722 W185 B30	DC operated central	-	-	910505103925	RC455X 36S/940 DLO W5 L1700 W150 B30 WT	DC operated central	-	-

# TrueBlend Recessed

Order Code	Full Product Name	Emergency lighting	Emergency flux	Power consumption during Central mode	Order Code	Full Product Name	Emergency lighting	Emergency flux	Power consumption during Central mode
910505105910	RC455X 40S/UE840 DLO W3W2 L1722 W150 B40	DC operated central emergency lighting	-	-	-	910505103941	RC455B 28S/940 MLO L1200 W100 B40	DC operated central emergency lighting	-
910505105918	RC455X 40S/BU840 DLO W3W2 L1722 W150 B30	DC operated central emergency lighting	-	-	-	910505103942	RC455B 36S/940 MLO L1200 W100 B40	DC operated central emergency lighting	-
910505103973	RC453B 42S/940 DLO 9010 U4 L1200 W300B30	DC operated central emergency lighting	-	-	-	910505103943	RC455B 36S/940 MLO L1200 W125 B40	DC operated central emergency lighting	-
910505103981	RC453B 40S/TW9 DLO U4 L1200 W300 B30	DC operated central emergency lighting	-	-	-	910505103944	RC455B 36S/940 MLO L1200 W150 B40	DC operated central emergency lighting	-
910505105909	RC453B 42S/940 DLO9010U4 L1200W300B30 SC	DC operated central emergency lighting	-	-	-	910505103945	RC455B 40S/940 MLO L1200 W100 B40	DC operated central emergency lighting	-
910505105915	RC453B 42S/UE840 DLO9010 U4 L1200W300B30	DC operated central emergency lighting	-	-	-	910505103946	RC455B 48S/940 MLO L1495 W100 B40	DC operated central emergency lighting	-
910505103984	RC453X 28S/840 DLO L1195 W298 B30	DC operated central emergency lighting	-	-	-	910505103947	RC455B 28S/TW9 MLO L1200 W100 B40	DC operated central emergency lighting	-
910505103980	RC453B 28S/UE840 MXO9010ELP3L1200W150B30	Emergency lighting 3 hours duration with DALI interface	405 lm	6 W	3 hour(s)	910505105903	RC455B 28S/940 MLO L1200 W100 B40 SC	DC operated central emergency lighting	-
910505103982	RC453B 28S/UE840 MXO L1200 W150 B30	DC operated	-	-	910505105904	RC455B 40S/940 MLO L1200 W100 B40 SC	DC operated	-	-

# TrueBlend Recessed

Order Code	Full Product Name	Emergency lighting	Emergency flux	Emergency mode	Power consumption during Central	Order Code	Full Product Name	Emergency lighting	Emergency flux	Emergency mode	Power consumption during Central DC
		central emergency lighting				910505103961	RC455B 365/940 MCW-M L1200 W100 B40	DC operated central emergency lighting	-	-	-
910505105917	RC455B 40S/BU840 MLO L1200 W100 B40	DC operated central emergency lighting	-	-	-	910505103963	RC455B 40S/940 MCW-M L1200 W100 B40	DC operated central emergency lighting	-	-	-
910505103971	RC453B 28S/840 DLO L1200 W300 B30	DC operated central emergency lighting	-	-	-	910505105906	RC455B 365/940 MCW-M L1200W100B40 SC	DC operated central emergency lighting	-	-	-
910505103972	RC453B 28S/840 DLO 9010 ELP3L1200W300B30	Emergency lighting 3 hours duration Pro version	520 lm	6 W	3 hour(s)	910505103968	RC455B 40S/940MCW-M U4W3 L1722 W150 B40	DC operated central emergency lighting	-	-	-
910505103977	RC453B 28S/840 DLO L1195 W298 B30	DC operated central emergency lighting	-	-	-	910505103916	RC455X 36S/940 DLO U4 W3 L1722 W100 B30	DC operated central emergency lighting	-	-	-
910505105907	RC453B 28S/840 DLO L1200W300B30 SC	DC operated central emergency lighting	-	-	-	910505103920	RC455X 40S/TW9 DLO U4 W3 L1722 W100 B30	DC operated central emergency lighting	-	-	-
910505105908	RC453B 40S/UE840 DLO L1200W300B30 SC	DC operated central emergency lighting	-	-	-	910505103923	RC455X 36S/940 DLOU5 9016W3 L1722W185B40	DC operated central emergency lighting	-	-	-
910505105914	RC453B 28S/UE840 DLO L1200 W300 B30	DC operated central emergency lighting	-	-	-	910505103931	RC455X 36S/930 DLO U4 W3 L1495 W100 B30	DC operated central emergency lighting	-	-	-
910505105916	RC453B 28S/BU840 DLO L1200W300B30	DC operated central emergency lighting	-	-	-	910505103975	RC453B 36S/940 DLO U5 L1200 W300 B30	DC operated central emergency lighting	-	-	-

## Approval and Application

Order Code	Full Product Name	Flickering value (PstLM) - Flickering value as per EN 61000-3-3
910505103952	RC455B 36S/940 MXO U4 L1200 W100 B40	-
910505103958	RC455B 40S/TW9 MXO U4 L1200 W100 B40	-
910505103960	RC455B 40S/940 MXO ELP3 W6L1722W150B40WT	-
910505103949	RC455B 28S/TW9 MLO U4 L1720 W124 B40	-
910505103950	RC455B 36S/940 MLO U4 W3 L1722 W100 B40	-
910505103974	RC453B42S/940DLO9010U4ELW3W4L1200W300B30	-
910505103976	RC453B 36S/940 DLO9010U4ELW3L1200W300B30	-
910505103957	RC455B 48S/940 MXO L1495 W100 B40	-
910505103959	RC455B 28S/TWBU MCW-M U4 L1200 W100 B40	-
910505103965	RC455B 36S/940 MCW-M U4 L1200 W100 B40	-
910505103978	RC453B 28S/UE840 MXO 9010 L1200 W300 B30	-
910505103979	RC453B 28S/UE840MXO9010ELP3 L1200W300B30	-
910505103951	RC455B 36S/940 MXO L1200 W100 B40	-
910505103953	RC455B 40S/940 MXO L1200 W100 B40	-
910505103954	RC455B 36S/940 MXO L1200 W125 B40	-
910505103955	RC455B 36S/940 MXO L1200 W150 B40	-
910505103956	RC455B 28S/940 MXO L1200 W150 B40	-
910505105905	RC455B 40S/940 MXO L1200 W100 B40 SC	1
910505103937	RC455B 40S/940 DLO U4 W3 L1722 W100 B30	-
910505103940	RC455B 36S/940 DLO L1200 W100 B30	-
910505103934	RC455X 36S/940 MCW-M U4 W3 L1722 W100B30	-
910505105902	RC455B 36S/940 MCW-M U4W3L1722W100B30SC	1
910505103926	RC455X 40S/940 DLO W3W2 L1700 W100 B30	-
910505103927	RC455X 40S/940 DLO W3W2 L1497 W150 B30	-
910505105901	RC455X 40S/940 DLO W3W2 L1497W150B30 SC	1
910505105913	RC455B 40S/UE 840 DLO L1200 W100 B30	1
910505103924	RC455X 36S/940 DLO U4 W3 L1722 W200 B40	-
910505105911	RC455X 36S/UE840 DLO U4 W3 L1722W200B40	1
910505103936	RC455B 36S/940 DLO 9010U4W3 L1722W150B30	-
910505103985	RC453X 28S/UE840MXO9010 U4W3L1200W150B30	-
910505103921	RC455X 28S/TWBU MCB-M U4 W3 L1722W100B30	-
910505103935	RC455X 36S/940 MCB-M U4 W3 L1722 W100B30	-
910505103967	RC455B 40S/940 MCB-M W3W2 L1722 W150 B30	-
910505103948	RC455B 28S/TW9 MLO U4 L1200 W100 B40	-
910505103918	RC455X 36S/940 DLO W5 L1722 W185 B30 WT	-
910505103930	RC455X 40S/940 DLO W3W2 L1497 W185 B30	-
910505103932	RC455X 36S/940 MLO W5 L1722 W185 B30 WT	-
910505105912	RC455B 36S/UE840 DLO W3W2 L1722 W185 B30	1
910505103962	RC455B 36S/940 MCB-M L1200 W100 B40	-
910505103964	RC455B 40S/940 MCB-M L1200 W100 B40	-
910505103966	RC455B 36S/940 MCB-M U4 L1200 W100 B40	-

Order Code	Full Product Name	Flickering value (PstLM) - Flickering value as per EN 61000-3-3
910505103938	RC455B 40S/940 DLO W3W2 L1722 W150 B30	-
910505103939	RC455B 36S/940 DLO W3W2 L1722 W185 B30	-
910505103917	RC455X 40S/940 DLO W3W2 L1722 W150 B30	-
910505103919	RC455X 40S/940 DLO W3W2 L1722 W150 B40	-
910505103922	RC455X 40S/930 DLO W3W2 L1722 W150 B30	-
910505103925	RC455X 36S/940 DLO W5 L1700 W150 B30 WT	-
910505105910	RC455X 40S/UE840 DLO W3W2 L1722 W150 B40	1
910505105918	RC455X 40S/BU840 DLO W3W2 L1722 W150 B30	1
910505103973	RC453B 42S/940 DLO 9010 U4 L1200 W300B30	-
910505103981	RC453B 40S/TW9 DLO U4 L1200 W300 B30	-
910505105909	RC453B 42S/940 DLO9010U4 L1200W300B30 SC	1
910505105915	RC453B 42S/UE840 DLO9010 U4 L1200W300B30	1
910505103984	RC453X 28S/840 DLO L1195 W298 B30	-
910505103980	RC453B 28S/UE840 MXO9010ELP3L1200W150B30	-
910505103982	RC453B 28S/UE840 MXO L1200 W150 B30	-
910505103941	RC455B 28S/940 MLO L1200 W100 B40	-
910505103942	RC455B 36S/940 MLO L1200 W100 B40	-
910505103943	RC455B 36S/940 MLO L1200 W125 B40	-
910505103944	RC455B 36S/940 MLO L1200 W150 B40	-
910505103945	RC455B 40S/940 MLO L1200 W100 B40	-
910505103946	RC455B 48S/940 MLO L1495 W100 B40	-
910505103947	RC455B 28S/TW9 MLO L1200 W100 B40	-
910505105903	RC455B 28S/940 MLO L1200 W100 B40 SC	1
910505105904	RC455B 40S/940 MLO L1200 W100 B40 SC	1
910505105917	RC455B 40S/BU840 MLO L1200 W100 B40	1
910505103971	RC453B 28S/840 DLO L1200 W300 B30	-
910505103972	RC453B 28S/840 DLO 9010 ELP3L1200W300B30	-
910505103977	RC453B 28S/840 DLO L1195 W298 B30	-
910505105907	RC453B 28S/840 DLO L1200W300B30 SC	1
910505105908	RC453B 40S/UE840 DLO L1200W300B30 SC	1
910505105914	RC453B 28S/UE840 DLO L1200 W300 B30	1
910505105916	RC453B 28S/BU840 DLO L1200W300B30	1
910505103961	RC455B 36S/940 MCW-M L1200 W100 B40	-
910505103963	RC455B 40S/940 MCW-M L1200 W100 B40	-
910505105906	RC455B 36S/940 MCW-M L1200W100B40 SC	1
910505103968	RC455B 40S/940MCW-M U4W3 L1722 W150 B40	-
910505103916	RC455X 36S/940 DLO U4 W3 L1722 W100 B30	-
910505103920	RC455X 40S/TW9 DLO U4 W3 L1722 W100 B30	-
910505103923	RC455X 36S/940 DLOU5 9016W3 L1722W185B40	-
910505103931	RC455X 36S/930 DLO U4 W3 L1495 W100 B30	-
910505103975	RC453B 36S/940 DLO U5 L1200 W300 B30	-

## Initial Performance (IEC Compliant)

## TrueBlend Recessed

Order Code	Full Product Name	Initial chromaticity
910505103952	RC455B 36S/940 MXO U4 L1200 W100 B40	(0.38, 0.38) SDCM ≤3.0
910505103958	RC455B 40S/TW9 MXO U4 L1200 W100 B40	Tunable, SDCM ≤3.0
910505103960	RC455B 40S/940 MXO ELP3 W6L1722W150B40WT	(0.38, 0.38) SDCM ≤3.0
910505103949	RC455B 28S/TW9 MLO U4 L1720 W124 B40	Tunable, SDCM ≤3.0
910505103950	RC455B 36S/940 MLO U4 W3 L1722 W100 B40	(0.38, 0.38) SDCM ≤3.0
910505103974	RC453B42S/ 940DLO9010U4ELW3W4L1200W300B30	(0.38, 0.38) SDCM ≤3.0
910505103976	RC453B 36S/940 DLO9010U4ELW3L1200W300B30	(0.38, 0.38) SDCM ≤3.0
910505103957	RC455B 48S/940 MXO L1495 W100 B40	(0.38, 0.38) SDCM ≤3.0
910505103959	RC455B 28S/TWBU MCW-M U4 L1200 W100 B40	Tunable, SDCM ≤3.0
910505103965	RC455B 36S/940 MCW-M U4 L1200 W100 B40	(0.38, 0.38) SDCM ≤3.0
910505103978	RC453B 28S/UE840 MXO 9010 L1200 W300 B30	(0.38, 0.38) SDCM ≤3.0
910505103979	RC453B 28S/UE840MXO9010ELP3 L1200W300B30	(0.38, 0.38) SDCM ≤3.0
910505103951	RC455B 36S/940 MXO L1200 W100 B40	(0.38, 0.38) SDCM ≤3.0
910505103953	RC455B 40S/940 MXO L1200 W100 B40	(0.38, 0.38) SDCM ≤3.0
910505103954	RC455B 36S/940 MXO L1200 W125 B40	(0.38, 0.38) SDCM ≤3.0
910505103955	RC455B 36S/940 MXO L1200 W150 B40	(0.38, 0.38) SDCM ≤3.0
910505103956	RC455B 28S/940 MXO L1200 W150 B40	(0.38, 0.38) SDCM ≤3.0
910505105905	RC455B 40S/940 MXO L1200 W100 B40 SC	(0.38, 0.38) SDCM ≤3.0
910505103937	RC455B 40S/940 DLO U4 W3 L1722 W100 B30	(0.38, 0.38) SDCM ≤3.0
910505103940	RC455B 36S/940 DLO L1200 W100 B30	(0.38, 0.38) SDCM ≤3.0
910505103934	RC455X 36S/940 MCW-M U4 W3 L1722 W100B30	(0.38, 0.38) SDCM ≤3.0
910505105902	RC455B 36S/940 MCW-M U4W3L1722W100B30SC	(0.38, 0.38) SDCM ≤3.0
910505103926	RC455X 40S/940 DLO W3W2 L1700 W100 B30	(0.38, 0.38) SDCM ≤3.0
910505103927	RC455X 40S/940 DLO W3W2 L1497 W150 B30	(0.38, 0.38) SDCM ≤3.0
910505105901	RC455X 40S/940 DLO W3W2 L1497W150B30 SC	(0.38, 0.38) SDCM ≤3.0

Order Code	Full Product Name	Initial chromaticity
910505105913	RC455B 40S/UE 840 DLO L1200 W100 B30	(0.38, 0.38) SDCM ≤3.0
910505103924	RC455X 36S/940 DLO U4 W3 L1722 W200 B40	(0.38, 0.38) SDCM ≤3.0
910505105911	RC455X 36S/UE840 DLO U4 W3 L1722W200B40	(0.38, 0.38) SDCM ≤3.0
910505103936	RC455B 36S/940 DLO 9010U4W3 L1722W150B30	(0.38, 0.38) SDCM ≤3.0
910505103985	RC453X 28S/UE840MXO9010 U4W3L1200W150B30	(0.38, 0.38) SDCM ≤3.0
910505103921	RC455X 28S/TWBU MCB-M U4 W3 L1722W100B30	Tunable, SDCM ≤3.0
910505103935	RC455X 36S/940 MCB-M U4 W3 L1722 W100B30	(0.38, 0.38) SDCM ≤3.0
910505103967	RC455B 40S/940 MCB-M W3W2 L1722 W150 B30	(0.38, 0.38) SDCM ≤3.0
910505103948	RC455B 28S/TW9 MLO U4 L1200 W100 B40	Tunable, SDCM ≤3.0
910505103918	RC455X 36S/940 DLO W5 L1722 W185 B30 WT	(0.38, 0.38) SDCM ≤3.0
910505103930	RC455X 40S/940 DLO W3W2 L1497 W185 B30	(0.38, 0.38) SDCM ≤3.0
910505103932	RC455X 36S/940 MLO W5 L1722 W185 B30 WT	(0.38, 0.38) SDCM ≤3.0
910505105912	RC455B 36S/UE840 DLO W3W2 L1722 W185 B30	(0.38, 0.38) SDCM ≤3.0
910505103962	RC455B 36S/940 MCB-M L1200 W100 B40	(0.38, 0.38) SDCM ≤3.0
910505103964	RC455B 40S/940 MCB-M L1200 W100 B40	(0.38, 0.38) SDCM ≤3.0
910505103966	RC455B 36S/940 MCB-M U4 L1200 W100 B40	(0.38, 0.38) SDCM ≤3.0
910505103938	RC455B 40S/940 DLO W3W2 L1722 W150 B30	(0.38, 0.38) SDCM ≤3.0
910505103939	RC455B 36S/940 DLO W3W2 L1722 W185 B30	(0.38, 0.38) SDCM ≤3.0
910505103917	RC455X 40S/940 DLO W3W2 L1722 W150 B30	(0.38, 0.38) SDCM ≤3.0
910505103919	RC455X 40S/940 DLO W3W2 L1722 W150 B40	(0.38, 0.38) SDCM ≤3.0
910505103922	RC455X 40S/930 DLO W3W2 L1722 W150 B30	(0.43, 0.40) SDCM ≤3.0
910505103925	RC455X 36S/940 DLO W5 L1700 W150 B30 WT	(0.38, 0.38) SDCM ≤3.0
910505105910	RC455X 40S/UE840 DLO W3W2 L1722 W150 B40	(0.38, 0.38) SDCM ≤3.0
910505105918	RC455X 40S/BU840 DLO W3W2 L1722 W150 B30	(0.38, 0.38) SDCM ≤3.0
910505103973	RC453B 42S/940 DLO 9010 U4 L1200 W300B30	(0.38, 0.38) SDCM ≤3.0

## TrueBlend Recessed

Order Code	Full Product Name	Initial chromaticity
910505103981	RC453B 40S/TW9 DLO U4 L1200 W300 B30	Tunable, SDCM ≤3.0
910505105909	RC453B 42S/940 DLO9010U4 L1200W300B30 SC	(0.38, 0.38) SDCM ≤3.0
910505105915	RC453B 42S/UE840 DLO9010 U4 L1200W300B30	(0.38, 0.38) SDCM ≤3.0
910505103984	RC453X 28S/840 DLO L1195 W298 B30	(0.38, 0.38) SDCM ≤3.0
910505103980	RC453B 28S/UE840 MXO9010ELP3L1200W150B30	(0.38, 0.38) SDCM ≤3.0
910505103982	RC453B 28S/UE840 MXO L1200 W150 B30	(0.38, 0.38) SDCM ≤3.0
910505103941	RC455B 28S/940 MLO L1200 W100 B40	(0.38, 0.38) SDCM ≤3.0
910505103942	RC455B 36S/940 MLO L1200 W100 B40	(0.38, 0.38) SDCM ≤3.0
910505103943	RC455B 36S/940 MLO L1200 W125 B40	(0.38, 0.38) SDCM ≤3.0
910505103944	RC455B 36S/940 MLO L1200 W150 B40	(0.38, 0.38) SDCM ≤3.0
910505103945	RC455B 40S/940 MLO L1200 W100 B40	(0.38, 0.38) SDCM ≤3.0
910505103946	RC455B 48S/940 MLO L1495 W100 B40	(0.38, 0.38) SDCM ≤3.0
910505103947	RC455B 28S/TW9 MLO L1200 W100 B40	Tunable, SDCM ≤3.0
910505105903	RC455B 28S/940 MLO L1200 W100 B40 SC	(0.38, 0.38) SDCM ≤3.0
910505105904	RC455B 40S/940 MLO L1200 W100 B40 SC	(0.38, 0.38) SDCM ≤3.0
910505105917	RC455B 40S/BU840 MLO L1200 W100 B40	(0.38, 0.38) SDCM ≤3.0

Order Code	Full Product Name	Initial chromaticity
910505103971	RC453B 28S/840 DLO L1200 W300 B30	(0.38, 0.38) SDCM ≤3.0
910505103972	RC453B 28S/840 DLO 9010 ELP3L1200W300B30	(0.38, 0.38) SDCM ≤3.0
910505103977	RC453B 28S/840 DLO L1195 W298 B30	(0.38, 0.38) SDCM ≤3.0
910505105907	RC453B 28S/840 DLO L1200W300B30 SC	(0.38, 0.38) SDCM ≤3.0
910505105908	RC453B 40S/UE840 DLO L1200W300B30 SC	(0.38, 0.38) SDCM ≤3.0
910505105914	RC453B 28S/UE840 DLO L1200 W300 B30	(0.38, 0.38) SDCM ≤3.0
910505105916	RC453B 28S/BU840 DLO L1200W300B30	(0.38, 0.38) SDCM ≤3.0
910505103961	RC455B 36S/940 MCW-M L1200 W100 B40	(0.38, 0.38) SDCM ≤3.0
910505103963	RC455B 40S/940 MCW-M L1200 W100 B40	(0.38, 0.38) SDCM ≤3.0
910505105906	RC455B 36S/940 MCW-M L1200W100B40 SC	(0.38, 0.38) SDCM ≤3.0
910505103968	RC455B 40S/940MCW-M U4W3 L1722 W150 B40	(0.38, 0.38) SDCM ≤3.0
910505103916	RC455X 36S/940 DLO U4 W3 L1722 W100 B30	(0.38, 0.38) SDCM ≤3.0
910505103920	RC455X 40S/TW9 DLO U4 W3 L1722 W100 B30	Tunable, SDCM ≤3.0
910505103923	RC455X 36S/940 DLOU5 9016W3 L1722W185B40	(0.38, 0.38) SDCM ≤3.0
910505103931	RC455X 36S/930 DLO U4 W3 L1495 W100 B30	(0.43, 0.40) SDCM ≤3.0
910505103975	RC453B 36S/940 DLO U5 L1200 W300 B30	(0.38, 0.38) SDCM ≤3.0

### Product Data

Order Code	Full Product Name	Product family code
910505103952	RC455B 36S/940 MXO U4 L1200 W100 B40	RC455B
910505103958	RC455B 40S/TW9 MXO U4 L1200 W100 B40	RC455B
910505103960	RC455B 40S/940 MXO ELP3 W6L1722W150B40WT	RC455B
910505103949	RC455B 28S/TW9 MLO U4 L1720 W124 B40	RC455B
910505103950	RC455B 36S/940 MLO U4 W3 L1722 W100 B40	RC455B
910505103974	RC453B42S/940DLO9010U4ELW3L1200W300B30	RC455B
910505103976	RC453B 36S/940 DLO9010U4ELW3L1200W300B30	RC455B
910505103957	RC455B 48S/940 MXO L1495 W100 B40	RC455B
910505103959	RC455B 28S/TWBU MCW-M U4 L1200 W100 B40	RC455B
910505103965	RC455B 36S/940 MCW-M U4 L1200 W100 B40	RC455B
910505103978	RC453B 28S/UE840 MXO 9010 L1200 W300 B30	RC455B
910505103979	RC453B 28S/UE840MXO9010ELP3 L1200W300B30	RC455B
910505103951	RC455B 36S/940 MXO L1200 W100 B40	RC455B
910505103953	RC455B 40S/940 MXO L1200 W100 B40	RC455B

Order Code	Full Product Name	Product family code
910505103954	RC455B 36S/940 MXO L1200 W125 B40	RC455B
910505103955	RC455B 36S/940 MXO L1200 W150 B40	RC455B
910505103956	RC455B 28S/940 MXO L1200 W150 B40	RC455B
910505105905	RC455B 40S/940 MXO L1200 W100 B40 SC	RC455B
910505103937	RC455B 40S/940 DLO U4 W3 L1722 W100 B30	RC455B
910505103940	RC455B 36S/940 DLO L1200 W100 B30	RC455B
910505103934	RC455X 36S/940 MCW-M U4 W3 L1722 W100B30	RC455B
910505105902	RC455B 36S/940 MCW-M U4W3L1722W100B30SC	RC455X
910505103926	RC455X 40S/940 DLO W3W2 L1700 W100 B30	RC455B
910505103927	RC455X 40S/940 DLO W3W2 L1497 W150 B30	RC455B
910505105901	RC455X 40S/940 DLO W3W2 L1497W150B30 SC	RC455X
910505105913	RC455B 40S/UE 840 DLO L1200 W100 B30	RC455B
910505103924	RC455X 36S/940 DLO U4 W3 L1722 W200 B40	RC455B
910505105911	RC455X 36S/UE840 DLO U4 W3 L1722W200B40	RC455X

# TrueBlend Recessed

Order Code	Full Product Name	Product family code
910505103936	RC455B 36S/940 DLO 9010U4W3 L1722W150B30	RC455B
910505103985	RC453X 28S/UE840MXO9010 U4W3L1200W150B30	RC455B
910505103921	RC455X 28S/TWBU MCB-M U4 W3 L1722W100B30	RC455B
910505103935	RC455X 36S/940 MCB-M U4 W3 L1722 W100B30	RC455B
910505103967	RC455B 40S/940 MCB-M W3W2 L1722 W150 B30	RC455B
910505103948	RC455B 28S/TW9 MLO U4 L1200 W100 B40	RC455B
910505103918	RC455X 36S/940 DLO W5 L1722 W185 B30 WT	RC455B
910505103930	RC455X 40S/940 DLO W3W2 L1497 W185 B30	RC455B
910505103932	RC455X 36S/940 MLO W5 L1722 W185 B30 WT	RC455B
910505105912	RC455B 36S/UE840 DLO W3W2 L1722 W185 B30	RC455B
910505103962	RC455B 36S/940 MCB-M L1200 W100 B40	RC455B
910505103964	RC455B 40S/940 MCB-M L1200 W100 B40	RC455B
910505103966	RC455B 36S/940 MCB-M U4 L1200 W100 B40	RC455B
910505103938	RC455B 40S/940 DLO W3W2 L1722 W150 B30	RC455B
910505103939	RC455B 36S/940 DLO W3W2 L1722 W185 B30	RC455B
910505103917	RC455X 40S/940 DLO W3W2 L1722 W150 B30	RC455B
910505103919	RC455X 40S/940 DLO W3W2 L1722 W150 B40	RC455B
910505103922	RC455X 40S/930 DLO W3W2 L1722 W150 B30	RC455B
910505103925	RC455X 36S/940 DLO W5 L1700 W150 B30 WT	RC455B
910505105910	RC455X 40S/UE840 DLO W3W2 L1722 W150 B40	RC455X
910505105918	RC455X 40S/BU840 DLO W3W2 L1722 W150 B30	RC455X
910505103973	RC453B 42S/940 DLO 9010 U4 L1200 W300B30	RC455B
910505103981	RC453B 40S/TW9 DLO U4 L1200 W300 B30	RC455B
910505105909	RC453B 42S/940 DLO9010U4 L1200W300B30 SC	RC453B
910505105915	RC453B 42S/UE840 DLO9010 U4 L1200W300B30	RC453B
910505103984	RC453X 28S/840 DLO L1195 W298 B30	RC455B
910505103980	RC453B 28S/UE840 MXO9010ELP3L1200W150B30	RC455B

Order Code	Full Product Name	Product family code
910505103982	RC453B 28S/UE840 MXO L1200 W150 B30	RC455B
910505103941	RC455B 28S/940 MLO L1200 W100 B40	RC455B
910505103942	RC455B 36S/940 MLO L1200 W100 B40	RC455B
910505103943	RC455B 36S/940 MLO L1200 W125 B40	RC455B
910505103944	RC455B 36S/940 MLO L1200 W150 B40	RC455B
910505103945	RC455B 40S/940 MLO L1200 W100 B40	RC455B
910505103946	RC455B 48S/940 MLO L1495 W100 B40	RC455B
910505103947	RC455B 28S/TW9 MLO L1200 W100 B40	RC455B
910505105903	RC455B 28S/940 MLO L1200 W100 B40 SC	RC455B
910505105904	RC455B 40S/940 MLO L1200 W100 B40 SC	RC455B
910505105917	RC455B 40S/BU840 MLO L1200 W100 B40	RC455B
910505103971	RC453B 28S/840 DLO L1200 W300 B30	RC455B
910505103972	RC453B 28S/840 DLO 9010 ELP3L1200W300B30	RC455B
910505103977	RC453B 28S/840 DLO L1195 W298 B30	RC455B
910505105907	RC453B 28S/840 DLO L1200W300B30 SC	RC453B
910505105908	RC453B 40S/UE840 DLO L1200W300B30 SC	RC453B
910505105914	RC453B 28S/UE840 DLO L1200 W300 B30	RC453B
910505105916	RC453B 28S/BU840 DLO L1200W300B30	RC453B
910505103961	RC455B 36S/940 MCW-M L1200 W100 B40	RC455B
910505103963	RC455B 40S/940 MCW-M L1200 W100 B40	RC455B
910505105906	RC455B 36S/940 MCW-M L1200W100B40 SC	RC455B
910505103968	RC455B 40S/940MCW-M U4W3 L1722 W150 B40	RC455B
910505103916	RC455X 36S/940 DLO U4 W3 L1722 W100 B30	RC455B
910505103920	RC455X 40S/TW9 DLO U4 W3 L1722 W100 B30	RC455B
910505103923	RC455X 36S/940 DLOU5 9016W3 L1722W185B40	RC455B
910505103931	RC455X 36S/930 DLO U4 W3 L1495 W100 B30	RC455B
910505103975	RC453B 36S/940 DLO U5 L1200 W300 B30	RC455B

## Polar Wide Diagrams

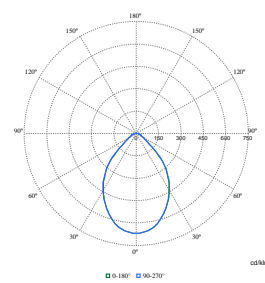
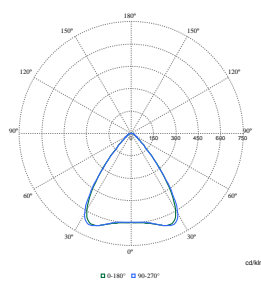
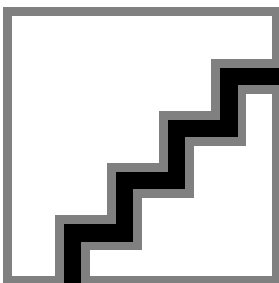

Polar Normal (separate) - RC450BI -  
910505103949

Polar Normal (separate) - RC450BI -  
910505103973

Polar Normal (separate) - RC450BI -  
910505103943

Polar Wide Diagrams

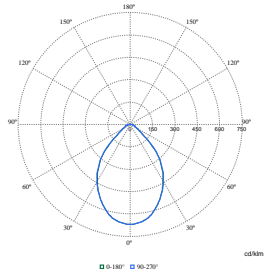

Polar Normal (separate) - RC450BI - 910505103948

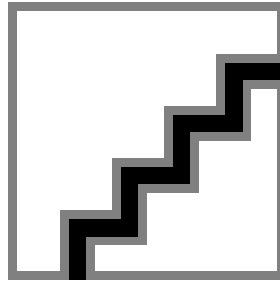

Polar Normal (separate) - RC450BI - 910505103918

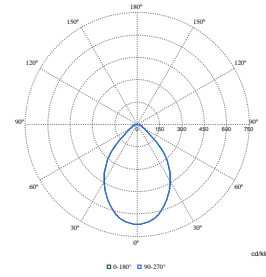

Polar Normal (separate) - RC450BI - 910505103941

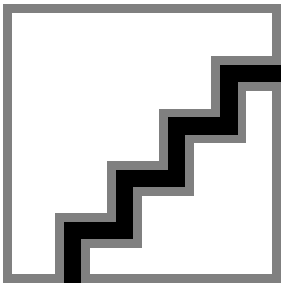

Polar Normal (separate) - RC450BI - 910505103946

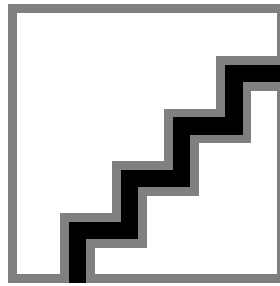

Polar Normal (separate) - RC450BI - 910505103921

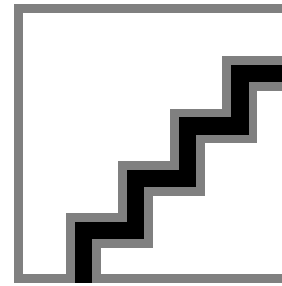

Polar Normal (separate) - RC450BI - 910505103960

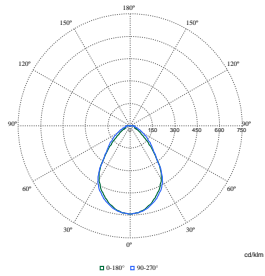

Polar Normal (separate) - RC450BI - 910505103980

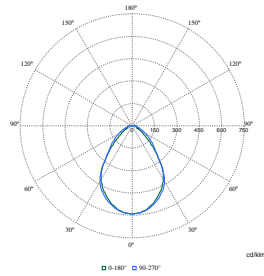

Polar Normal (separate) - RC450BI - 910505103985

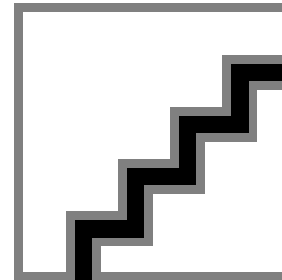

Polar Normal (separate) - RC450BI - 910505103917

Polar Wide Diagrams

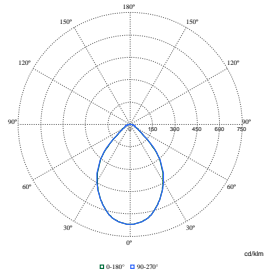

Polar Normal (separate) - RC450BI - 910505103942

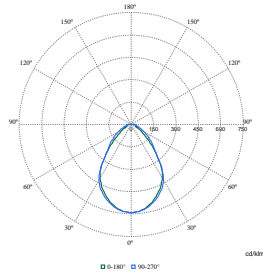

Polar Normal (separate) - RC450BI - 910505103955

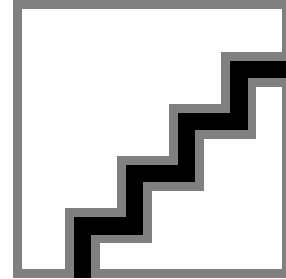

Polar Normal (separate) - RC450BI - 910505103919

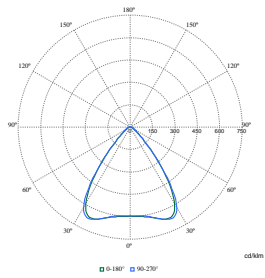

Polar Normal (separate) - RC450BI - 910505103974

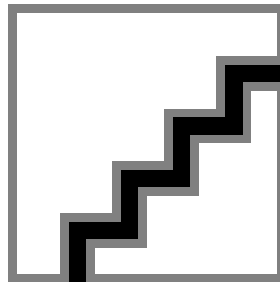

Polar Normal (separate) - RC450BI - 910505103932

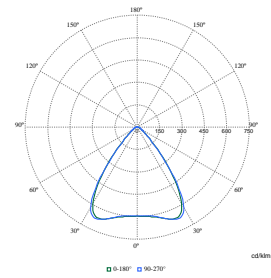

Polar Normal (separate) - RC450BI - 910505103981

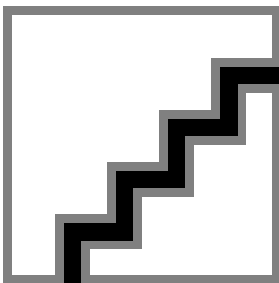

Polar Normal (separate) - RC450BI - 910505103931

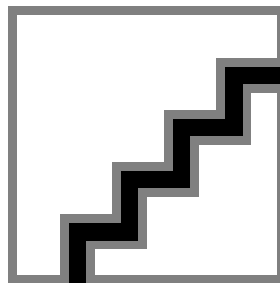

Polar Normal (separate) - RC450BI - 910505103916

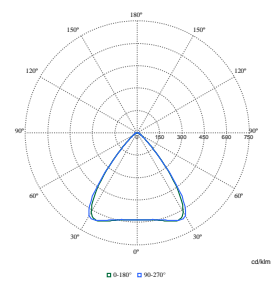

Polar Normal (separate) - RC450BI - 910505103926

Polar Wide Diagrams

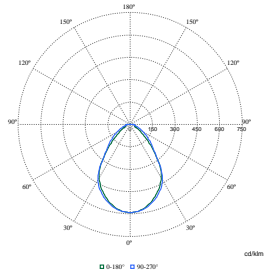

Polar Normal (separate) - RC450BI - 910505103954

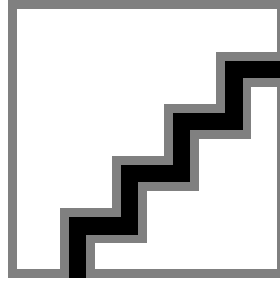

Polar Normal (separate) - RC450BI - 910505103920

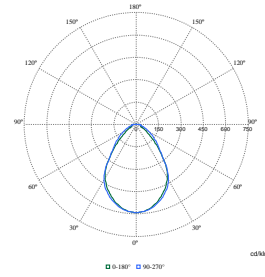

Polar Normal (separate) - RC450BI - 910505103978

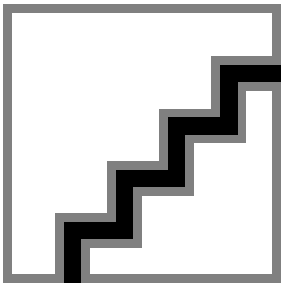

Polar Normal (separate) - RC450BI - 910505103944

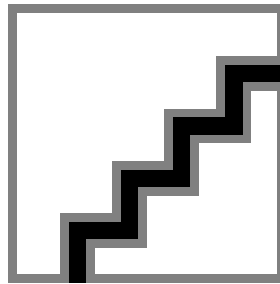

Polar Normal (separate) - RC450BI - 910505103958

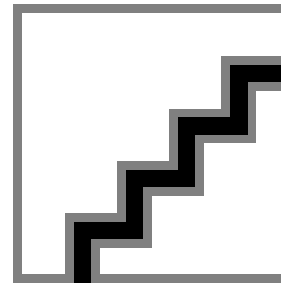

Polar Normal (separate) - RC450BI - 910505103967

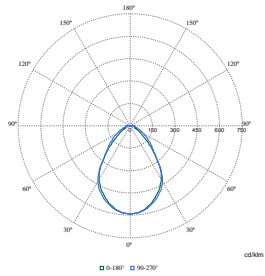

Polar Normal (separate) - RC450BI - 910505103953

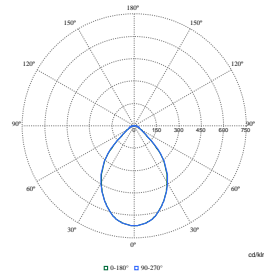

Polar Normal (separate) - RC450BI - 910505103947

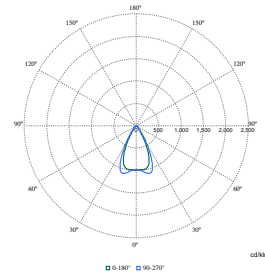

Polar Normal (separate) - RC450BI - 910505103964

## Polar Wide Diagrams

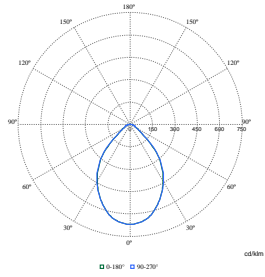

**Polar Normal (separate) - RC450BI - 910505103945**

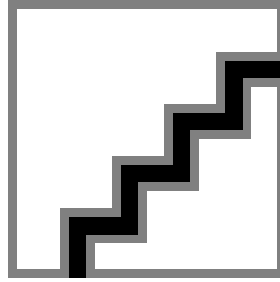

**Polar Normal (separate) - RC450BI - 910505103957**

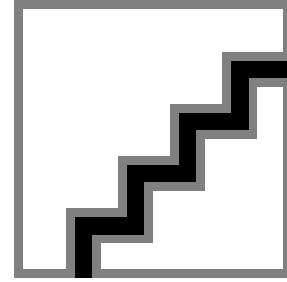

**Polar Normal (separate) - RC450BI - 910505103950**

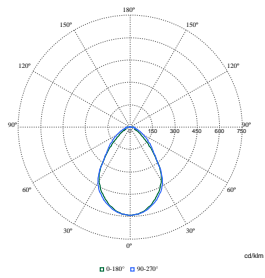

**Polar Normal (separate) - RC450BI - 910505103952**

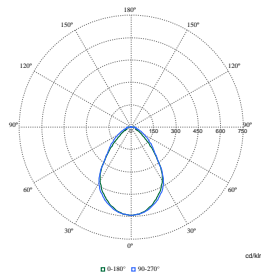

**Polar Normal (separate) - RC450BI - 910505103956**

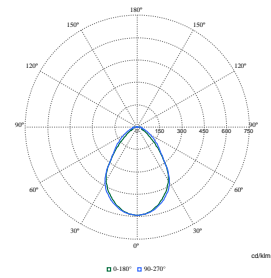

**Polar Normal (separate) - RC450BI - 910505103979**

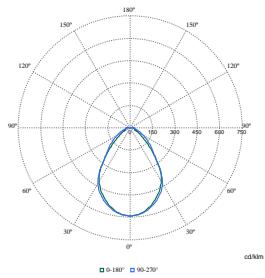

**Polar Normal (separate) - RC450BI - 910505103951**

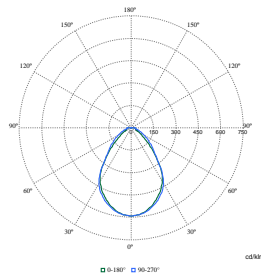

**Polar Normal (separate) - RC450BI - 910505103982**

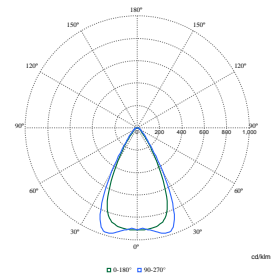

**Polar Normal (separate) - RC450BI - 910505103961**

# TrueBlend Recessed

## Polar Wide Diagrams

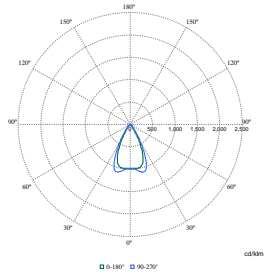

**Polar Normal (separate) - RC450BI - 910505103962**

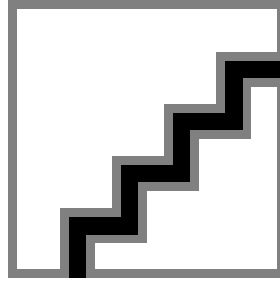

**Polar Normal (separate) - RC450BI - 910505103927**

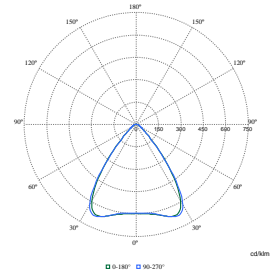

**Polar Normal (separate) - RC450BI - 910505103940**

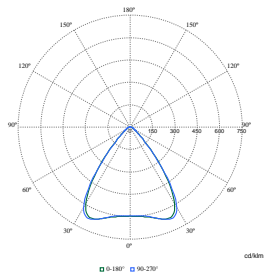

**Polar Normal (separate) - RC450BI - 910505103971**

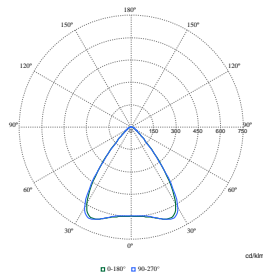

**Polar Normal (separate) - RC450BI - 910505103972**

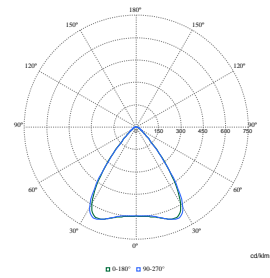

**Polar Normal (separate) - RC450BI - 910505103977**

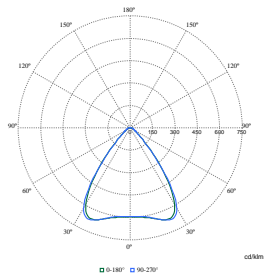

**Polar Normal (separate) - RC450BI - 910505103984**

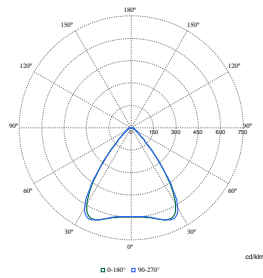

**Polar Normal (separate) - RC450BI - 910505103976**

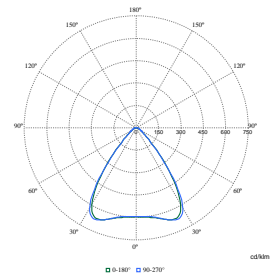

**Polar Normal (separate) - RC450BI - 910505103975**

Polar Wide Diagrams

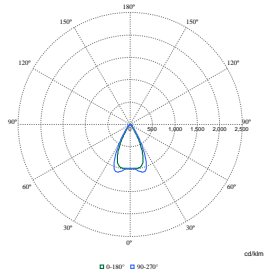

Polar Normal (separate) - RC450BI - 910505103966

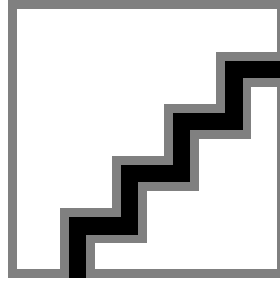

Polar Normal (separate) - RC450BI - 910505103922

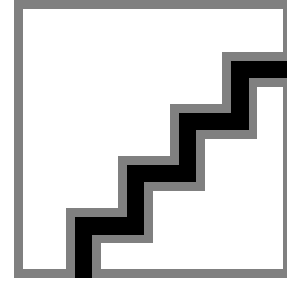

Polar Normal (separate) - RC450BI - 910505103934

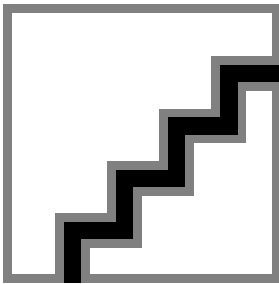

Polar Normal (separate) - RC450BI - 910505103924

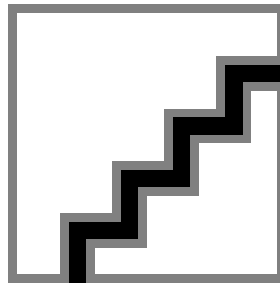

Polar Normal (separate) - RC450BI - 910505103968

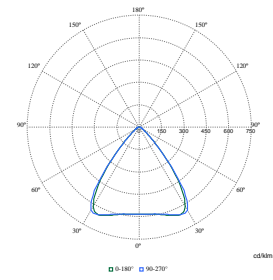

Polar Normal (separate) - RC450BI - 910505103925

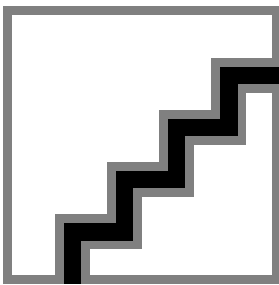

Polar Normal (separate) - RC450BI - 910505103937

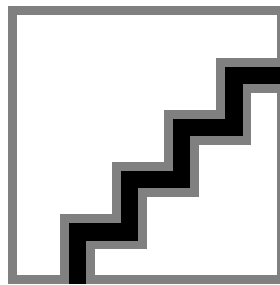

Polar Normal (separate) - RC450BI - 910505103923

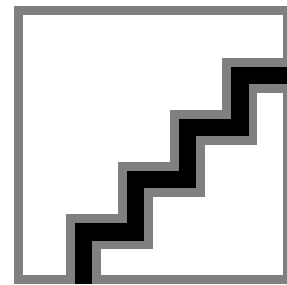

Polar Normal (separate) - RC450BI - 910505103936

Polar Wide Diagrams

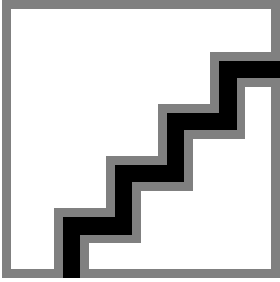

Polar Normal (separate) - RC450BI - 910505103938

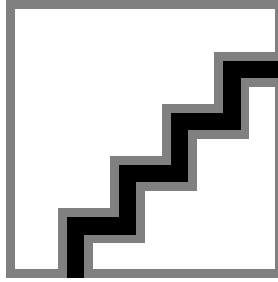

Polar Normal (separate) - RC450BI - 910505103930

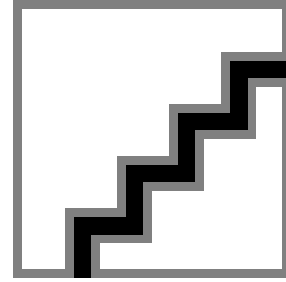

Polar Normal (separate) - RC450BI - 910505103935

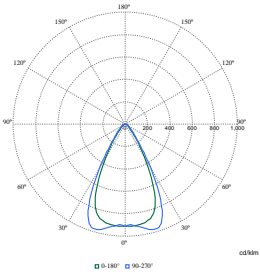

Polar Normal (separate) - RC450BI - 910505103965

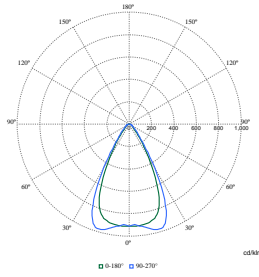

Polar Normal (separate) - RC450BI - 910505103963

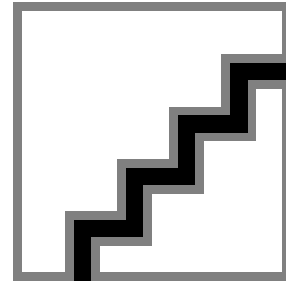

Polar Normal (separate) - RC450BI - 910505103939

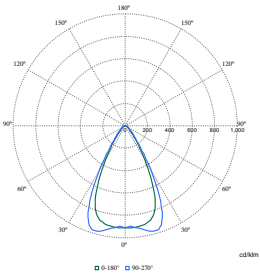

Polar Normal (separate) - RC450BI - 910505103959

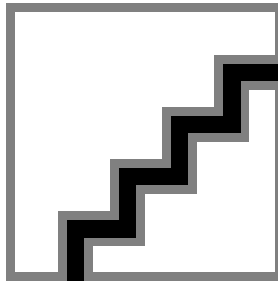

Polar Normal (separate) - RC450BI - 910505105901

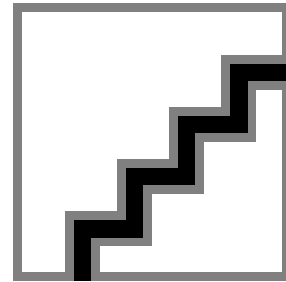

Polar Normal (separate) - RC450BI - 910505105902

Polar Wide Diagrams

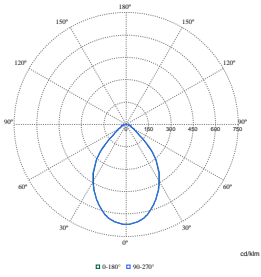

Polar Normal (separate) - RC450BI - 910505105904

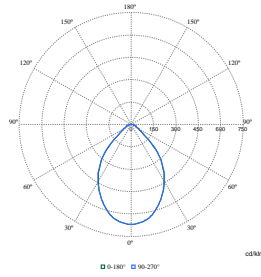

Polar Normal (separate) - RC450BI - 910505105903

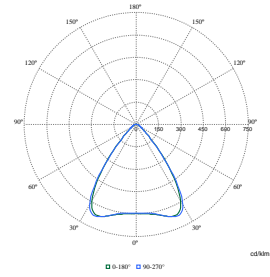

Polar Normal (separate) - RC450BI - 910505105909

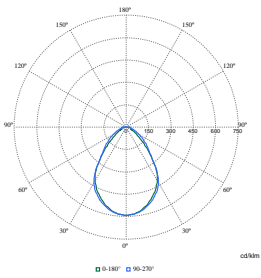

Polar Normal (separate) - RC450BI - 910505105905

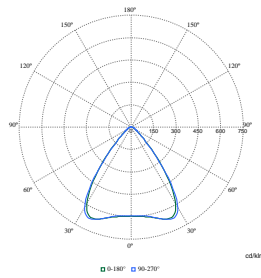

Polar Normal (separate) - RC450BI - 910505105907

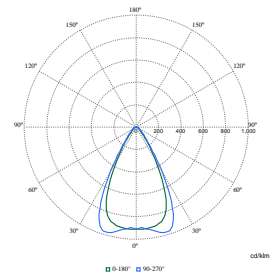

Polar Normal (separate) - RC450BI - 910505105906

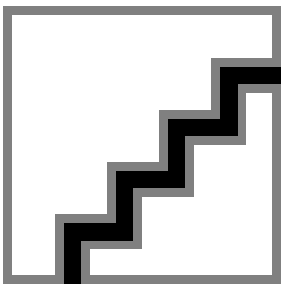

Polar Normal (separate) - null - 910505105908

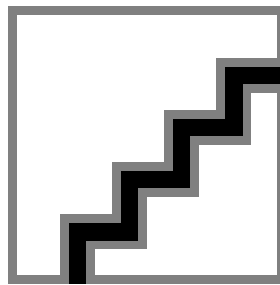

Polar Normal (separate) - null - 910505105910

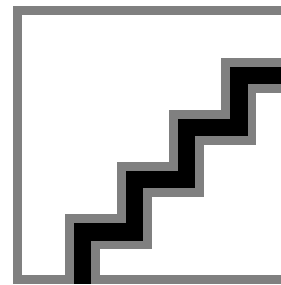

Polar Normal (separate) - null - 910505105915

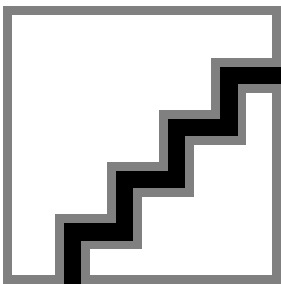

Polar Normal (separate) - null - 910505105917

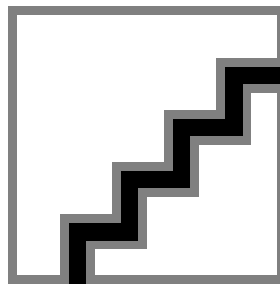

Polar Normal (separate) - null - 910505105911

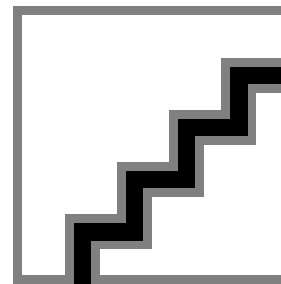

Polar Normal (separate) - null - 910505105913

# TrueBlend Recessed

## Polar Wide Diagrams

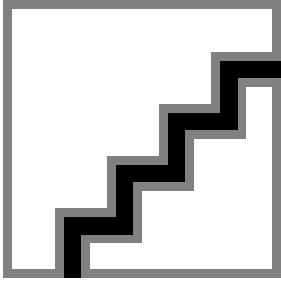

Polar Normal (separate) - null - 910505105912

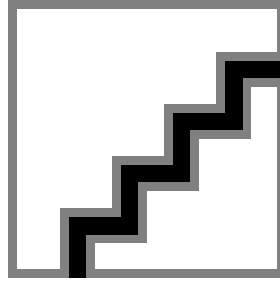

Polar Normal (separate) - null - 910505105914

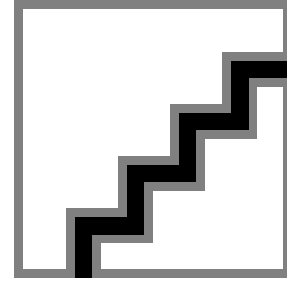

Polar Normal (separate) - null - 910505105916

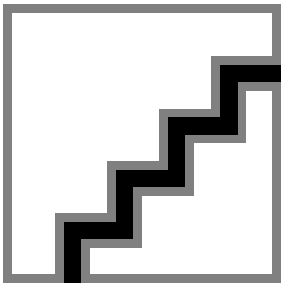

Polar Normal (separate) - null - 910505105918

