



CoreLine recessed: easy installation, excellent illumination

CoreLine recessed gen 4

Introducing Philips CoreLine recessed gen4 – a sleek, modern and energy-efficient lighting solution for offices, education, and healthcare. With higher lumen packages up to 6800 lm, improved efficiency and lifetime, and easy installation with quick connectors or Wieland connectors, Philips Coreline recessed gen4 delivers on the Philips promise of innovative, easy-to-use, high-quality luminaires. Our state-of-the-art LED technology ensures that CoreLine recessed lighting is both eco-friendly and cost-effective, saving you money on your energy bills and helping to reduce your carbon footprint. Upgrade your office, education, or healthcare lighting with CoreLine recessed today and enjoy bright and long-lasting illumination that blends seamlessly with any interior décor.

Benefits

- Energy-efficient: Our state-of-the-art LED technology ensures that CoreLine recessed luminaires are both eco-friendly and cost-effective, saving you money on your energy bills and helping to reduce your carbon footprint
- Bright and effective: With higher lumen packages up to 6800 lm, CoreLine recessed luminaires deliver bright and effective illumination for your home, office, or classroom.
- Easy installation: Quick connectors make installation a breeze, ensuring a hassle-free and user-friendly experience.
- Modern design: With its sleek and modern design, CoreLine recessed gen4 blends seamlessly with any interior décor, enhancing the atmosphere of any space.
- Long-lasting: Improved efficiency and lifetime ensure long-lasting and eco-friendly lighting that will last for years to come.

CoreLine recessed gen 4

Features

- Higher lumen packages up to 6800 lm (replacing 2 x 58W conventional light sources) for bright and effective illumination
- Improved efficiency: up to 160 lm/W for energy-saving and eco-friendly lighting
- Improved lifetime: L90@50K hrs/ L80@100K hrs for long-lasting and durable lighting
- Emergency lighting via EL Kit (recessed) for added safety and security
- Plastics-free packaging for an eco-friendly solution
- EPDs available for all listed products
- Improved all-in driver: more user-friendly, with no dipswitches for ease of use

Application

- Offices
- Healthcare
- Education

Versions



CoreLine recessed G4 W30L120

Dimensional drawing

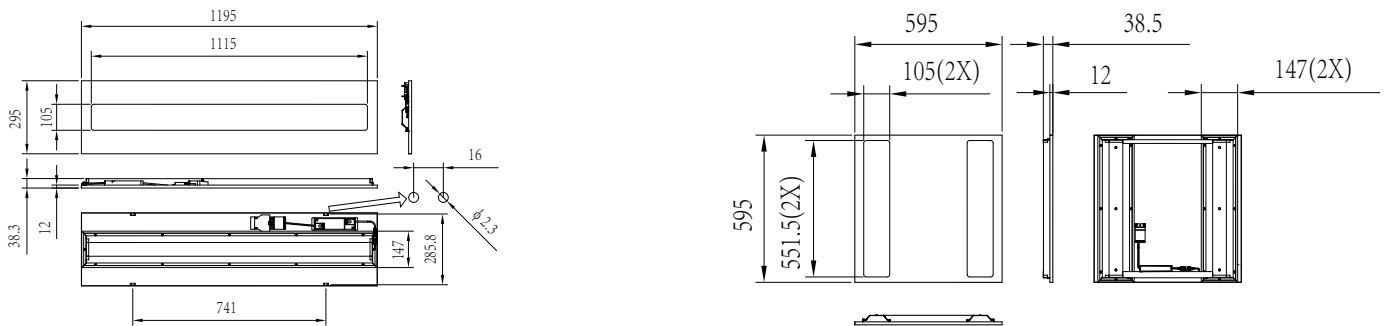

CoreLine recessed gen 4

Product details

CoreLine recessed G4 PSU
W60L60 back side



CoreLine recessed G4 W60L60 OC
Optical window



CoreLine recessed G4 W30L120
OC Optical window



CoreLine recessed G4 PSD
W30L120 back side detail

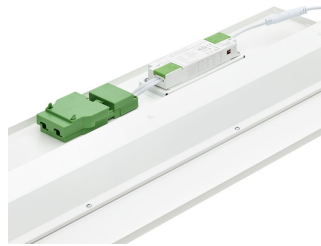

CoreLine recessed G4 W60L60
DPP



CoreLine recessed G4 PSU
W60L60 back side detail



CoreLinerecessed G4 W30L120
DPP



CoreLine recessed G4 W60L60
NOC Optical window



CoreLine recessed gen 4

Product details

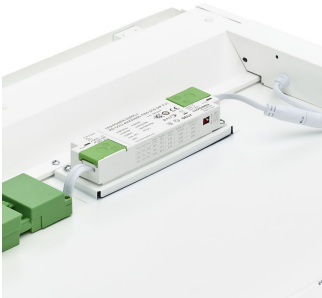

CoreLine recessed G4 PSD
W60L60 back side detail

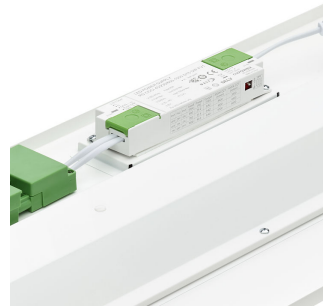

CoreLine recessed G4 PSD
W30L120 back side detail
dipswitches



CoreLine G4 PSU All in lumen
selectable side

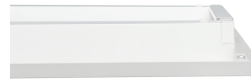

CoreLine recessed G4 W60L60
side view



CoreLine G4 PSD All in lumen
selectable back



CoreLine recessed G4 PSD
W60L60 back side

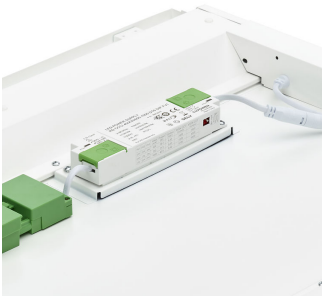

CoreLine recessed G4 PSD
W60L60 back side detail
dipswitches

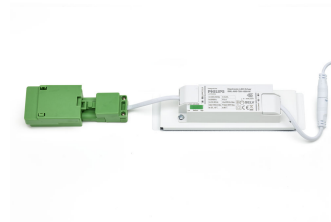

CoreLine G4 PSU All in lumen
selectable back

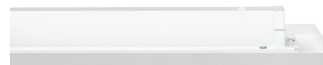

CoreLine recessed G4 W30L120
side view

CoreLine recessed gen 4

Product details

CoreLine G4 PSD All in lumen
selectable side



CoreLine recessed G4 PSD
W30L120 back side



CoreLine recessed gen 4

General Information

| | |
|----------------------|--------|
| Driver included | Yes |
| Number of gear units | 1 unit |

Light Technical

| | |
|-----------------------------|-----|
| Color rendering index (CRI) | >80 |
|-----------------------------|-----|

Operating and Electrical

| | |
|-------------------------------|-----------------|
| Protection class IEC | Safety class II |
| Input Voltage | 220-240 V |
| Line Frequency | 50 or 60 Hz |
| Suitable for random switching | No |

Mechanical and Housing

| | |
|------------------------------|---------|
| Housing Color | White |
| Mech. impact protection code | IK03 |
| Ingress protection code | IP20/44 |

Emergency Operation

| | |
|--------------------|---|
| Central Emergency | No |
| Emergency lighting | Self-contained emergency lighting is possible when used with a compatible battery kit accessory |
| Emergency flux | 380 lm |

Approval and Application

| | |
|---------------------------|---|
| Ambient temperature range | -10 to +40 °C |
| CE mark | Yes |
| ENEC mark | ENEC mark |
| Flammability mark | For mounting on normally flammable surfaces |
| Glow-wire test | Temperature 650 °C, duration 30 s |

Initial Performance (IEC Compliant)

| | |
|-------------------------|--------|
| Luminous flux tolerance | +/-10% |
|-------------------------|--------|

Light Technical (1/2)

| Order Code | Full Product Name | All-in Type | Correlated Color Temperature (Nom) | Luminous Efficacy (rated) (Nom) | Luminous Flux |
|------------|--|---------------------|------------------------------------|---------------------------------|---------------|
| 76417099 | RC136B G4 40S/830 WIA W60L60 OC | - | 3000 K | 145 lm/W | 4,000 lm |
| 76419499 | RC136B G4 43S/840 WIA W60L60 OC | - | 4000 K | 156 lm/W | 4,300 lm |
| 76412599 | RC136B G4 34_43_57S/830 PSD W60L60 OC | All-in, Multi Lumen | 3000 K | 148 lm/W | 3,400 lm |
| 76414999 | RC136B G4 36_45_60S/840 PSD W60L60 OC | All-in, Multi Lumen | 4000 K | 157 lm/W | 3,600 lm |
| 76415699 | RC136B G4 36_45_60S/840 PSU W60L60 NOC | All-in, Multi Lumen | 4000 K | 157 lm/W | 3,600 lm |
| 76416399 | RC136B G4 36_45_60S/840 PSU W60L60 OC | All-in, Multi Lumen | 4000 K | 157 lm/W | 3,600 lm |
| 76418799 | RC136B G4 43S/840 WIA W30L120 OC | - | 4000 K | 156 lm/W | 4,300 lm |
| 76411899 | RC136B G4 34_43_57S/830 PSD W30L120 OC | All-in, Multi Lumen | 3000 K | 148 lm/W | 3,400 lm |
| 76413299 | RC136B G4 36_45_60S/840 PSD W30L120 OC | All-in, Multi Lumen | 4000 K | 157 lm/W | 3,600 lm |

Light Technical (2/2)

| Order Code | Full Product Name | Optic type |
|------------|--|----------------------------|
| 76417099 | RC136B G4 40S/830 WIA W60L60 OC | Wide beam office compliant |
| 76419499 | RC136B G4 43S/840 WIA W60L60 OC | Wide beam office compliant |
| 76412599 | RC136B G4 34_43_57S/830 PSD W60L60 OC | Wide beam office compliant |
| 76414999 | RC136B G4 36_45_60S/840 PSD W60L60 OC | Wide beam office compliant |
| 76415699 | RC136B G4 36_45_60S/840 PSU W60L60 NOC | Very wide beam |

| Order Code | Full Product Name | Optic type |
|------------|--|----------------------------|
| 76416399 | RC136B G4 36_45_60S/840 PSU W60L60 OC | Wide beam office compliant |
| 76418799 | RC136B G4 43S/840 WIA W30L120 OC | Wide beam office compliant |
| 76411899 | RC136B G4 34_43_57S/830 PSD W30L120 OC | Wide beam office compliant |
| 76413299 | RC136B G4 36_45_60S/840 PSD W30L120 OC | Wide beam office compliant |

CoreLine recessed gen 4

Operating and Electrical

| Order Code | Full Product Name | Power Consumption |
|------------|--|-------------------|
| 76417099 | RC136B G4 40S/830 WIA W60L60 OC | 27.5 W |
| 76419499 | RC136B G4 43S/840 WIA W60L60 OC | 27.5 W |
| 76412599 | RC136B G4 34_43_57S/830 PSD W60L60 OC | 38.5 W |
| 76414999 | RC136B G4 36_45_60S/840 PSD W60L60 OC | 38.5 W |
| 76415699 | RC136B G4 36_45_60S/840 PSU W60L60 NOC | 38.5 W |

| Order Code | Full Product Name | Power Consumption |
|------------|--|-------------------|
| 76416399 | RC136B G4 36_45_60S/840 PSU W60L60 OC | 38.5 W |
| 76418799 | RC136B G4 43S/840 WIA W30L120 OC | 27.5 W |
| 76411899 | RC136B G4 34_43_57S/830 PSD W30L120 OC | 38.5 W |
| 76413299 | RC136B G4 36_45_60S/840 PSD W30L120 OC | 38.5 W |

Controls and Dimming

| Order Code | Full Product Name | Dimmable |
|------------|--|----------|
| 76417099 | RC136B G4 40S/830 WIA W60L60 OC | Yes |
| 76419499 | RC136B G4 43S/840 WIA W60L60 OC | Yes |
| 76412599 | RC136B G4 34_43_57S/830 PSD W60L60 OC | Yes |
| 76414999 | RC136B G4 36_45_60S/840 PSD W60L60 OC | Yes |
| 76415699 | RC136B G4 36_45_60S/840 PSU W60L60 NOC | No |

| Order Code | Full Product Name | Dimmable |
|------------|--|----------|
| 76416399 | RC136B G4 36_45_60S/840 PSU W60L60 OC | No |
| 76418799 | RC136B G4 43S/840 WIA W30L120 OC | Yes |
| 76411899 | RC136B G4 34_43_57S/830 PSD W30L120 OC | Yes |
| 76413299 | RC136B G4 36_45_60S/840 PSD W30L120 OC | Yes |

Initial Performance (IEC Compliant)

| Order Code | Full Product Name | Initial chromaticity |
|------------|--|----------------------|
| 76417099 | RC136B G4 40S/830 WIA W60L60 OC | (0.44,0.40)SDCM<3 |
| 76419499 | RC136B G4 43S/840 WIA W60L60 OC | (0.38,0.38)SDCM<3 |
| 76412599 | RC136B G4 34_43_57S/830 PSD W60L60 OC | (0.44,0.40)SDCM<3 |
| 76414999 | RC136B G4 36_45_60S/840 PSD W60L60 OC | (0.38,0.38)SDCM<3 |
| 76415699 | RC136B G4 36_45_60S/840 PSU W60L60 NOC | (0.38,0.38)SDCM<3 |

| Order Code | Full Product Name | Initial chromaticity |
|------------|--|----------------------|
| 76416399 | RC136B G4 36_45_60S/840 PSU W60L60 OC | (0.38,0.38)SDCM<3 |
| 76418799 | RC136B G4 43S/840 WIA W30L120 OC | (0.38,0.38)SDCM<3 |
| 76411899 | RC136B G4 34_43_57S/830 PSD W30L120 OC | (0.44,0.40)SDCM<3 |
| 76413299 | RC136B G4 36_45_60S/840 PSD W30L120 OC | (0.38,0.38)SDCM<3 |

