



CoreLine panel: easy installation, excellent illumination

CoreLine Panel gen6

Philips CoreLine panel Gen6 delivers on the CoreLine promise of innovation, easy installation, and excellent illumination. Designed as a direct replacement for functional luminaires in general lighting applications, this LED panel light's innovative All-in feature offers a choice of three lumen packages and three-color temperatures in a single luminaire. This makes it easy to select the right product, gives you the flexibility respond to customer preferences on site, and means fewer product codes on stock. Installing the CoreLine RC132V LED panel is quick and easy, using the product's quick connector or flywire. The CoreLine range includes Interact Ready luminaires with integrated wireless communications, ready to be used with Interact gateways, sensors, and software.

Benefits

- Low-risk, reliable products
- Work faster with these easy-to-install products
- No confusion with easy product selection
- Stay relevant by joining IoT / connected lighting systems

Features

- L90@50K hrs/ L80@100K hrs with 5-year warranty
- Quick connector (green/white, Flywire, WAGO, and Schuko)
- High lumen office-compliant and non-office compliant versions
- CRI 80/CRI 90 at SDCM <3
- CRI 80 4000 K 140 lm/W and 3000 K > 130 lm/W, CRI 90 >115 lm/W
- UltraEfficient 4000 K >160 lm/W
- All-in: multiple lumen packages and color temperatures in one luminaire

CoreLine Panel gen6

Application

- Offices
- Healthcare
- Municipal buildings
- Education

Versions

CoreLine panel G5 SIA with Sensor
front side



Philips CoreLine panel G6 All in
W30L120



CoreLine panel G6 W30L120 RTP



CoreLine panel G6 W60L60 IP65



CoreLine Panel G6 W60xL120 RTP



Philips CoreLine panel G6 All in
MultiLumen W60L60



Philips CoreLine panel G6 All in
W60L60



CoreLine Panel G6 Concealed
Celing version 599x599

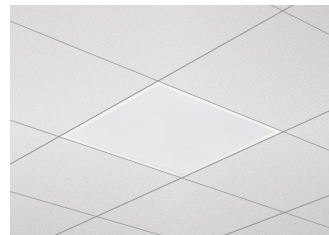

CoreLine Panel gen6

Dimensional drawing

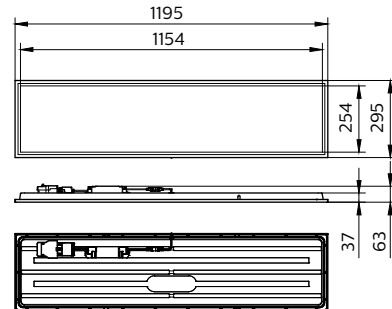
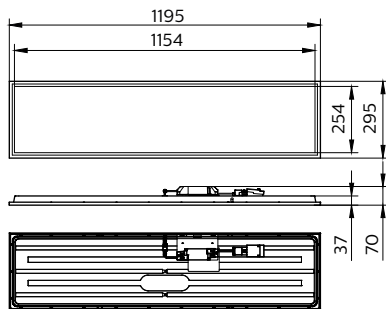
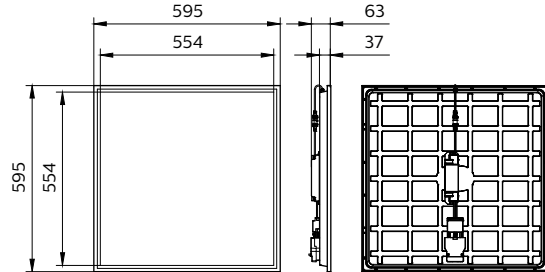
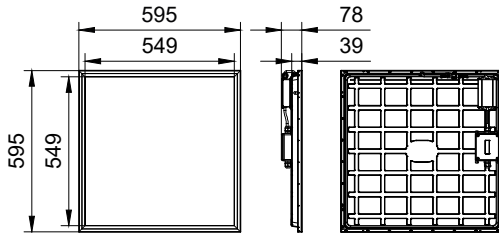
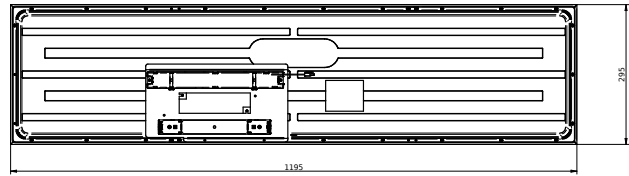
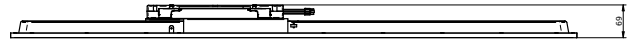
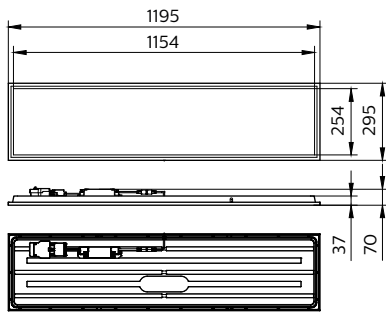
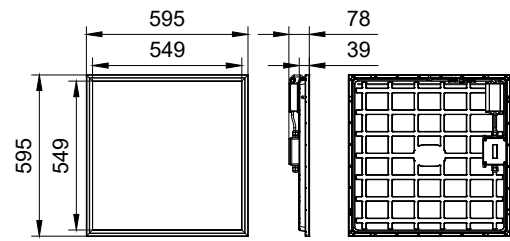
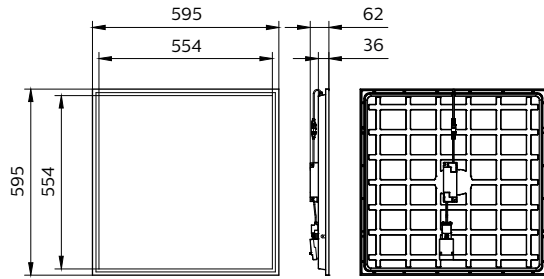

CoreLine Panel gen6

Dimensional drawing

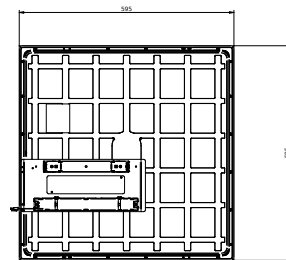
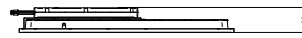
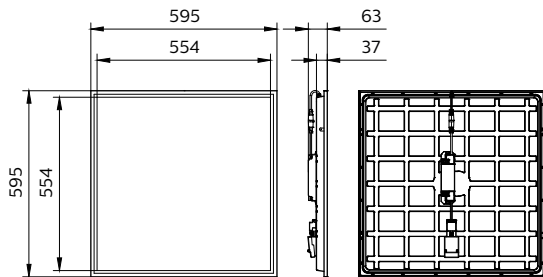
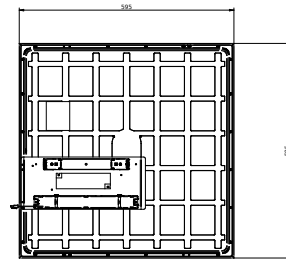
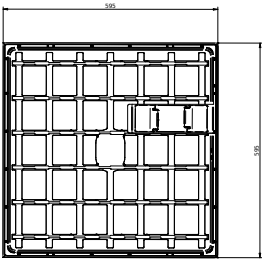
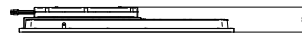
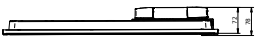
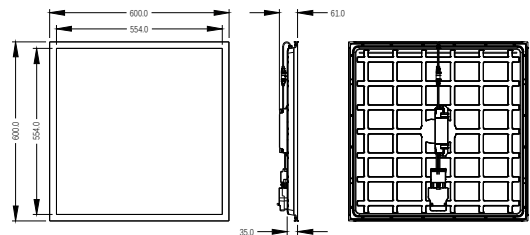
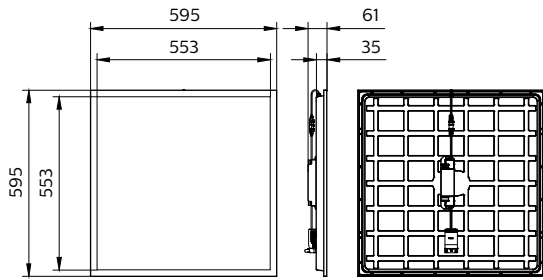
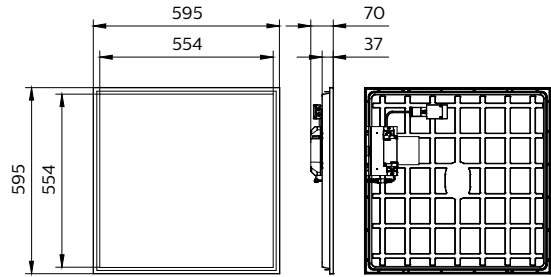
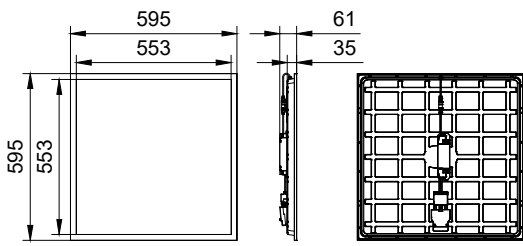

CoreLine Panel gen6

Dimensional drawing

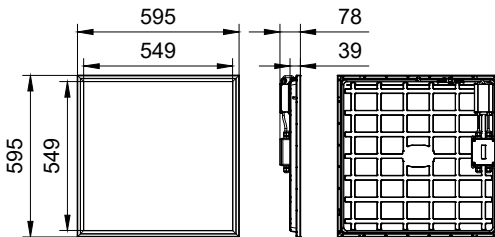
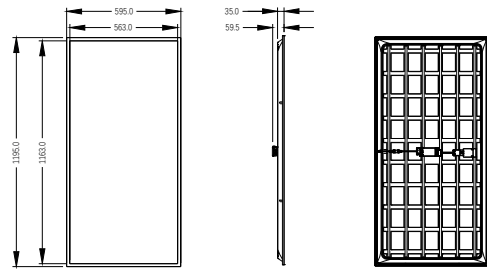
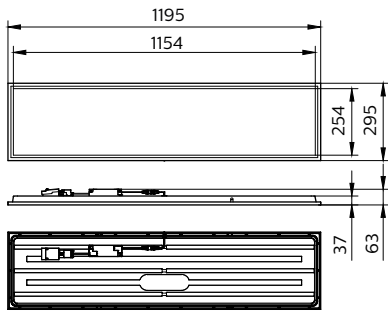
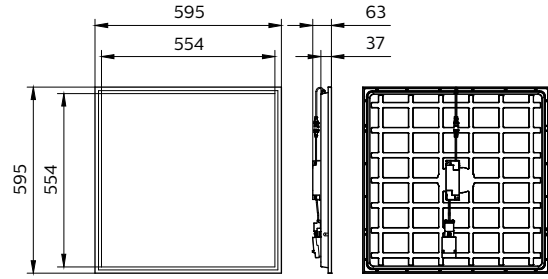
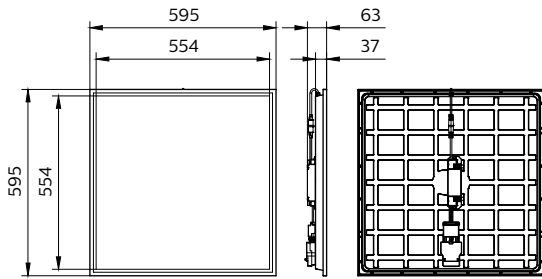

Product details



CoreLine panel G6 PSU Green
connector fits Wieland W3
connector



CoreLine panel G6 PSU W60L60
back side DPP

CoreLine Panel gen6

Product details



CoreLine panel G6 IP65 PSU driver

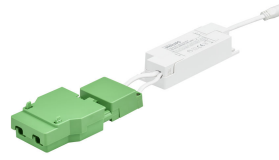

CoreLine panel G6 PSU driver DPP



CoreLine panel G6 WIA back side DPP



CoreLine panel G6 PSU W30L120 back side DPP



CoreLine panel G6 PSD W30L120 back side DPP



CoreLine panel G6 PSD driver open DPP



CoreLine Panel G6 Concealed Ceiling version 599x599 detail frontside



CoreLine panel G6 PSD All in W60L60 back side DPP



CoreLine Panel RC132V IK03 ELR Optic



CoreLine panel G6 IP65 PSD driver

CoreLine Panel gen6

Product details

CoreLine panel G6 side angle DPP

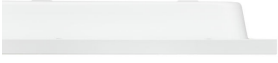

CoreLine panel G6 WIA driver DPP



CoreLine panel G6 NOC Optical window DPP



CoreLine panel G6 All in driver open DPP



CoreLine panel G6 All in driver DPP

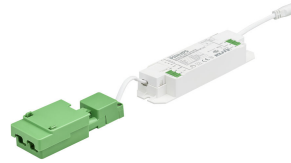

CoreLine panel G6 PSU driver open DPP

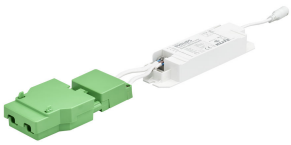

CoreLine panel G6 PSD W60L60 back side DPP



CoreLine Panel G6 Concealed Ceiling version 599x599 backside closed brackets



CoreLine Panel G6 Concealed Ceiling version 599x599 detail backside



CoreLine Panel gen6

Product details



CoreLine Panel G6 Concealed
Ceiling version 599x599 backside
open brackets



CoreLine panel G6 IP65 PSD back
side



CoreLine Panel RC132V IK03 ELR
Backplate



CoreLine panel G6 W60L60 OC
Optical window DPP



CoreLine panel G6 IP65 PSU back
side

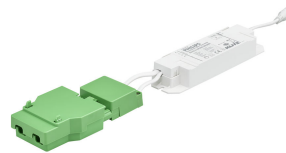

CoreLine panel G6 PSD driver DPP

General Information

Driver included	Yes
Number of gear units	Unit

Operating and Electrical

Protection class IEC	Safety class II
----------------------	-----------------

Mechanical and Housing

Explosion hazard class	-
------------------------	---

Approval and Application

CE mark	Yes
ENEC mark	ENEC mark
Flickering value (PstLM)	1
Stroboscopic effect	0.4

Initial Performance (IEC Compliant)

Luminous flux tolerance	-10% / +10%
-------------------------	-------------

General Information

Order Code	Full Product Name	Service Tag
910505102802	RC132V G6 43S/840 SIA W60L60 OC IA4	Yes
911401801187	RC132V G6 29_36_43S/830_40 PSDW30L120OC	Yes
910505102819	RC132V G6 36S/840 PSU W30L120 OC ELB3	Yes
911401802887	RC132V G6 36S/840 WIA W30L120 OC	Yes
911401890785	RC132V G6 36S/840 PSU W30L120 OC	Yes
911401891085	RC132V G6 36S/840 PSD W30L120 OC	Yes
911401891685	RC132V G6 50S/940 PSU W60L60 NOC IP65	Yes
911401891785	RC132V G6 48S/940 PSU W60L60 OC IP65	Yes
911401891885	RC132V G6 48S/940 PSD W60L60 OC IP65	Yes
911401888287	RC132V 60S/840 PSU W60L120 OC	-
910505102816	RC132V G6 36S/840 PSU W60L60 OC ELB3	Yes
910505102817	RC132V G6 36S/840 PSD W60L60 OC ELB3	Yes
911401800187	RC132V G6 36S/UE840 PSU W60L60 OC	Yes
911401800287	RC132V G6 36S/UE840 PSD W60L60 OC	Yes
911401802487	RC132V G6 43S/840 WIA W60L60 OC	Yes
911401807687	RC132V G6 34S/830 PSU W60L60 OC	Yes
911401830488	RC132V G6 31_43S/840 PSU ELR IK03 60x60	-
911401890285	RC132V G6 36S/840 PSU W60L60 NOC	Yes

CoreLine Panel gen6

Order Code	Full Product Name	Service Tag
911401890885	RC132V G6 36S/840 PSD W60L60 OC	Yes
911401818787	RC132V G6 31_36_43S/840 PSU W60L60OCUKI	Yes
911401891185	RC132V G6 29_36_43S/830_40 PSU W60L60 OC	Yes
911401891285	RC132V G6 29_36_43S/830_40 PSD W60L60 OC	Yes
911401888487	RC132V G6 36S/UE840 PSD 599x599SQ OC CPC	-

Light Technical (1/2)

Order Code	Full Product Name	All-in Type	Beam angle of light source	Correlated Colour Temperature (Nom)	Colour rendering index (CRI)	Order Code	Full Product Name	All-in Type	Beam angle of light source	Correlated Colour Temperature (Nom)	Colour rendering index (CRI)
910505102802	RC132V G6 43S/840 SIA W60L60 OC IA4	-	90 degree(s)	4000 K	>80	911401800187	RC132V G6 36S/ UE840 PSU W60L60 OC	-	90 degree(s)	4000 K	>80
911401801187	RC132V G6 29_36_43S/ 830_40 PSDW30L120OC	All-in, Multi Lumen	90 degree(s)	3000 K	>80	911401800287	RC132V G6 36S/ UE840 PSD W60L60 OC	-	90 degree(s)	4000 K	>80
910505102819	RC132V G6 36S/840 PSU W30L120 OC ELB3	All-in, Multi Color Temperature	90 degree(s)	4000 K	>80	911401802487	RC132V G6 43S/840 WIA W60L60 OC	-	90 degree(s)	4000 K	>80
911401802887	RC132V G6 36S/840 WIA W30L120 OC	-	90 degree(s)	4000 K	>80	911401807687	RC132V G6 34S/830 PSU W60L60 OC	-	90 degree(s)	3000 K	>80
911401890785	RC132V G6 36S/840 PSU W30L120 OC	-	90 degree(s)	4000 K	>80	911401830488	RC132V G6 31_43S/840 PSU ELR IK03 60x60	All-in, Multi Lumen	-	4000 K	>80
911401891085	RC132V G6 36S/840 PSD W30L120 OC	-	90 degree(s)	4000 K	>80	911401890285	RC132V G6 36S/840 PSU W60L60 NOC	-	120 degree(s)	4000 K	>80
911401891685	RC132V G6 50S/940 PSU W60L60 NOC IP65	-	120 degree(s)	4000 K	>90	911401890885	RC132V G6 36S/840 PSD W60L60 OC	-	90 degree(s)	4000 K	>80
911401891785	RC132V G6 48S/940 PSU W60L60 OC IP65	-	90 degree(s)	4000 K	>90	911401818787	RC132V G6 31_36_43S/840 PSU W60L60OCUKI	All-in, Multi Lumen	90 degree(s)	4000 K	>80
911401891885	RC132V G6 48S/940 PSD W60L60 OC IP65	-	90 degree(s)	4000 K	>90	911401891185	RC132V G6 29_36_43S/ 830_40 PSU W60L60 OC	All-in, Multi Lumen	90 degree(s)	3000 K	>80
911401888287	RC132V 60S/840 PSU W60L120 OC	-	-	4000 K	>80	911401891285	RC132V G6 29_36_43S/ 830_40 PSD W60L60 OC	All-in, Multi Lumen	90 degree(s)	3000 K	>80
910505102816	RC132V G6 36S/840 PSU W60L60 OC ELB3	-	90 degree(s)	4000 K	>80	911401888487	RC132V G6 36S/ UE840 PSD 599x599SQ OC CPC	-	-	4000 K	>80
910505102817	RC132V G6 36S/840 PSD W60L60 OC ELB3	-	90 degree(s)	4000 K	>80						

Light Technical (2/2)

CoreLine Panel gen6

Order Code	Full Product Name	Luminous	Luminous	Optic type
		efficacy (rated) (nom.)	Flux	
910505102802	RC132V G6 43S/840 SIA W60L60 OC IA4	135 lm/W	4,300 lm	Beam angle 90°
911401801187	RC132V G6 29_36_43S/830_40 PSDW30L120OC	140 lm/W	2,900 lm	Beam angle 90°
910505102819	RC132V G6 36S/840 PSU W30L120 OC ELB3	133 lm/W	3,600 lm	Beam angle 90°
911401802887	RC132V G6 36S/840 WIA W30L120 OC	140 lm/W	3,600 lm	Beam angle 90°
911401890785	RC132V G6 36S/840 PSU W30L120 OC	140 lm/W	3,600 lm	Beam angle 90°
911401891085	RC132V G6 36S/840 PSD W30L120 OC	140 lm/W	3,600 lm	Beam angle 90°
911401891685	RC132V G6 50S/940 PSU W60L60 NOC IP65	110 lm/W	5,000 lm	Beam angle 120°
911401891785	RC132V G6 48S/940 PSU W60L60 OC IP65	105 lm/W	4,800 lm	Beam angle 90°
911401891885	RC132V G6 48S/940 PSD W60L60 OC IP65	105 lm/W	4,800 lm	Beam angle 90°
911401888287	RC132V 60S/840 PSU W60L120 OC	140 lm/W	6,000 lm	Beam angle 90°
910505102816	RC132V G6 36S/840 PSU W60L60 OC ELB3	133 lm/W	3,600 lm	Beam angle 90°
910505102817	RC132V G6 36S/840 PSD W60L60 OC ELB3	133 lm/W	3,600 lm	Beam angle 90°

Order Code	Full Product Name	Luminous	Luminous	Optic type
		efficacy (rated) (nom.)	Flux	
911401800187	RC132V G6 36S/UE840 PSU W60L60 OC	160 lm/W	3,600 lm	Beam angle 90°
911401800287	RC132V G6 36S/UE840 PSD W60L60 OC	153 lm/W	3,600 lm	Beam angle 90°
911401802487	RC132V G6 43S/840 WIA W60L60 OC	140 lm/W	4,300 lm	Beam angle 90°
911401807687	RC132V G6 34S/830 PSU W60L60 OC	130 lm/W	3,400 lm	Beam angle 90°
911401830488	RC132V G6 31_43S/840 PSU ELR IK03 60x60	140 lm/W	3,100 lm	Beam angle 90°
911401890285	RC132V G6 36S/840 PSU W60L60 NOC	140 lm/W	3,600 lm	Beam angle 120°
911401890885	RC132V G6 36S/840 PSD W60L60 OC	140 lm/W	3,600 lm	Beam angle 90°
911401818787	RC132V G6 31_36_43S/840 PSU W60L60OCUKI	140 lm/W	3,100 lm	Beam angle 90°
911401891185	RC132V G6 29_36_43S/830_40 PSU W60L60 OC	140 lm/W	2,900 lm	Beam angle 90°
911401891285	RC132V G6 29_36_43S/830_40 PSD W60L60 OC	140 lm/W	2,900 lm	Beam angle 90°
911401888487	RC132V G6 36S/UE840 PSD 599x599SQ OC CPC	153 lm/W	3,600 lm	Beam angle 90°

Operating and Electrical

Order Code	Full Product Name	Input Voltage	Line Frequency	Power Consumption	Suitable for
					random switching
910505102802	RC132V G6 43S/840 SIA W60L60 OC IA4	220-240 V	50 to 60 Hz	32 W	No
911401801187	RC132V G6 29_36_43S/830_40 PSDW30L120OC	220 to 240 V	50 or 60 Hz	31 W	Not applicable
910505102819	RC132V G6 36S/840 PSU W30L120 OC ELB3	220-240 V	50 to 60 Hz	27 W	No
911401802887	RC132V G6 36S/840 WIA W30L120 OC	220 to 240 V	50 or 60 Hz	26 W	Not applicable
911401890785	RC132V G6 36S/840 PSU W30L120 OC	220 to 240 V	50 or 60 Hz	26 W	Not applicable
911401891085	RC132V G6 36S/840 PSD W30L120 OC	220 to 240 V	50 or 60 Hz	26 W	Not applicable

Order Code	Full Product Name	Input Voltage	Line Frequency	Power Consumption	Suitable for
					random switching
911401891685	RC132V G6 50S/940 PSU W60L60 NOC IP65	220 to 240 V	50 or 60 Hz	45 W	Not applicable
911401891785	RC132V G6 48S/940 PSU W60L60 OC IP65	220 to 240 V	50 or 60 Hz	45 W	Not applicable
911401891885	RC132V G6 48S/940 PSD W60L60 OC IP65	220 to 240 V	50 or 60 Hz	45 W	Not applicable
911401888287	RC132V 60S/840 PSU W60L120 OC	220 to 240 V	50 or 60 Hz	43 W	Not applicable
910505102816	RC132V G6 36S/840 PSU W60L60 OC ELB3	220-240 V	50 to 60 Hz	27 W	No
910505102817	RC132V G6 36S/840 PSD W60L60 OC ELB3	220-240 V	50 to 60 Hz	27 W	No

CoreLine Panel gen6

Order Code	Full Product Name	Input Voltage	Line Frequency	Power Consumption	Suitable for random switching
911401800187	RC132V G6 36S/ UE840 PSU W60L60 OC	220 to 240 V	50 or 60 Hz	22.5 W	Not applicable
911401800287	RC132V G6 36S/ UE840 PSD W60L60 OC	220 to 240 V	50 or 60 Hz	23.5 W	Not applicable
911401802487	RC132V G6 43S/840 WIA W60L60 OC	220 to 240 V	50 or 60 Hz	31 W	Not applicable
911401807687	RC132V G6 34S/830 PSU W60L60 OC	220 to 240 V	50 or 60 Hz	26 W	Not applicable
911401830488	RC132V G6 31_43S/840 PSU ELR IK03 60x60	220 to 240 V	50 or 60 Hz	31 W	Not applicable
911401890285	RC132V G6 36S/840 PSU W60L60 NOC	220 to 240 V	50 or 60 Hz	26 W	Not applicable
911401890885	RC132V G6 36S/840 PSD W60L60 OC	220 to 240 V	50 or 60 Hz	26 W	Not applicable

Order Code	Full Product Name	Input Voltage	Line Frequency	Power Consumption	Suitable for random switching
911401818787	RC132V G6 31_36_43S/840 PSU W60L60OCUKI	220 to 240 V	50 or 60 Hz	31 W	Not applicable
911401891185	RC132V G6 29_36_43S/ 830_40 PSU W60L60 OC	220 to 240 V	50 or 60 Hz	31 W	Not applicable
911401891285	RC132V G6 29_36_43S/ 830_40 PSD W60L60 OC	220 to 240 V	50 or 60 Hz	31 W	Not applicable
911401888487	RC132V G6 36S/ UE840 PSD 599x599SQ OC CPC	220 to 240 V	50 or 60 Hz	23.5 W	Not applicable

Controls and Dimming

Order Code	Full Product Name	Dimmable	Embedded control	Maximum dim level
910505102802	RC132V G6 43S/840 SIA W60L60 OC IA4	Yes	Interact SC200 sensor	10%
911401801187	RC132V G6 29_36_43S/ 830_40 PSDW30L120OC	Yes	-	1%
910505102819	RC132V G6 36S/840 PSU W30L120 OC ELB3	No	-	Not applicable
911401802887	RC132V G6 36S/840 WIA W30L120 OC	Yes	-	1%
911401890785	RC132V G6 36S/840 PSU W30L120 OC	No	-	Not applicable
911401891085	RC132V G6 36S/840 PSD W30L120 OC	Yes	-	1%
911401891685	RC132V G6 50S/940 PSU W60L60 NOC IP65	No	-	Not applicable
911401891785	RC132V G6 48S/940 PSU W60L60 OC IP65	No	-	Not applicable
911401891885	RC132V G6 48S/940 PSD W60L60 OC IP65	Yes	-	1%
911401888287	RC132V 60S/840 PSU W60L120 OC	No	-	Not applicable
910505102816	RC132V G6 36S/840 PSU W60L60 OC ELB3	No	-	Not applicable

Order Code	Full Product Name	Dimmable	Embedded control	Maximum dim level
910505102817	RC132V G6 36S/840 PSD W60L60 OC ELB3	Yes	-	10%
911401800187	RC132V G6 36S/UE840 PSU W60L60 OC	No	-	Not applicable
911401800287	RC132V G6 36S/UE840 PSD W60L60 OC	Yes	-	1%
911401802487	RC132V G6 43S/840 WIA W60L60 OC	Yes	-	1%
911401807687	RC132V G6 34S/830 PSU W60L60 OC	No	-	Not applicable
911401830488	RC132V G6 31_43S/840 PSU ELR IK03 60x60	No	-	-
911401890285	RC132V G6 36S/840 PSU W60L60 NOC	No	-	Not applicable
911401890885	RC132V G6 36S/840 PSD W60L60 OC	Yes	-	1%
911401818787	RC132V G6 31_36_43S/840 PSU W60L60OCUKI	No	-	Not applicable
911401891185	RC132V G6 29_36_43S/ 830_40 PSU W60L60 OC	No	-	Not applicable
911401891285	RC132V G6 29_36_43S/ 830_40 PSD W60L60 OC	Yes	-	1%

CoreLine Panel gen6

Order Code	Full Product Name	Dimmable	Embedded control	Maximum dim level
911401888487	RC132V G6 36S/UE840 PSD 599x599SQ OC CPC	Yes	-	1%

Mechanical and Housing

Order Code	Full Product Name	Housing Colour	Mech. impact protection code	Ingress protection code
910505102802	RC132V G6 43S/840 SIA W60L60 OC IA4	White	IK02	IP20
911401801187	RC132V G6 29_36_43S/ 830_40 PSDW30L120OC	White	IK02	IP20/44
910505102819	RC132V G6 36S/840 PSU W30L120 OC ELB3	White	IK03	IP20/44
911401802887	RC132V G6 36S/840 WIA W30L120 OC	White	IK02	IP20/44
911401890785	RC132V G6 36S/840 PSU W30L120 OC	White	IK02	IP20/44
911401891085	RC132V G6 36S/840 PSD W30L120 OC	White	IK02	IP20/44
911401891685	RC132V G6 50S/940 PSU W60L60 NOC IP65	White	IK03	IP65
911401891785	RC132V G6 48S/940 PSU W60L60 OC IP65	White	IK03	IP65
911401891885	RC132V G6 48S/940 PSD W60L60 OC IP65	White	IK03	IP65
911401888287	RC132V 60S/840 PSU W60L120 OC	White	IK03	IP20 (IP44 front)
910505102816	RC132V G6 36S/840 PSU W60L60 OC ELB3	White	IK03	IP20/44
910505102817	RC132V G6 36S/840 PSD W60L60 OC ELB3	White	IK03	IP20/44

Order Code	Full Product Name	Housing Colour	Mech. impact protection code	Ingress protection code
911401800187	RC132V G6 36S/UE840 PSU W60L60 OC	White	IK02	IP20/44
911401800287	RC132V G6 36S/UE840 PSD W60L60 OC	White	IK02	IP20/44
911401802487	RC132V G6 43S/840 WIA W60L60 OC	White	IK02	IP20/44
911401807687	RC132V G6 34S/830 PSU W60L60 OC	White	IK02	IP20/44
911401830488	RC132V G6 31_43S/840 PSU ELR IK03 60x60	White RAL 9003	IK03	IP20/40
911401890285	RC132V G6 36S/840 PSU W60L60 NOC	White	IK03	IP20/44
911401890885	RC132V G6 36S/840 PSD W60L60 OC	White	IK02	IP20/44
911401818787	RC132V G6 31_36_43S/840 PSU W60L60OCUKI	White	IK02	IP20/40
911401891185	RC132V G6 29_36_43S/ 830_40 PSU W60L60 OC	White	IK02	IP20/44
911401891285	RC132V G6 29_36_43S/ 830_40 PSD W60L60 OC	White	IK02	IP20/44
911401888487	RC132V G6 36S/UE840 PSD 599x599SQ OC CPC	White	IK02	IP20 (front IP40)

Emergency Operation (1/2)

Order Code	Full Product Name	Central Emergency	Emergency lighting	Emergency flux	Type of emergency lighting battery
910505102802	RC132V G6 43S/840 SIA W60L60 OC IA4	No	-	-	-
911401801187	RC132V G6 29_36_43S/ 830_40 PSDW30L120OC	No	-	-	-
910505102819	RC132V G6 36S/840 PSU W30L120 OC ELB3	No	Emergency lighting 3- hours	250 lm	Lithium

Order Code	Full Product Name	Central Emergency	Emergency lighting	Emergency flux	Type of emergency lighting battery
911401802887	RC132V G6 36S/840 WIA W30L120 OC	No	-	-	-
911401890785	RC132V G6 36S/840 PSU W30L120 OC	No	-	-	-

CoreLine Panel gen6

Order Code	Full Product Name	Central Emergency	Emergency lighting	Emergency flux	Type of emergency lighting battery
911401891085	RC132V G6 36S/840 PSD W30L120 OC	No	-	-	-
911401891685	RC132V G6 50S/940 PSU W60L60 NOC IP65	No	-	-	-
911401891785	RC132V G6 48S/940 PSU W60L60 OC IP65	No	-	-	-
911401891885	RC132V G6 48S/940 PSD W60L60 OC IP65	No	-	-	-
911401888287	RC132V 60S/840 PSU W60L120 OC	No	Emergency lighting ready (through compatible battery kit accessory)	380 lm	-
910505102816	RC132V G6 36S/840 PSU W60L60 OC ELB3	No	Emergency lighting 3- hours duration basic version	250 lm	Lithium
910505102817	RC132V G6 36S/840 PSD W60L60 OC ELB3	No	Emergency lighting 3- hours duration basic version	250 lm	Lithium
911401800187	RC132V G6 36S/ UE840 PSU W60L60 OC	No	-	-	-
911401800287	RC132V G6 36S/ UE840 PSD W60L60 OC	No	-	-	-
911401802487	RC132V G6 43S/840 WIA W60L60 OC	No	-	-	-

Order Code	Full Product Name	Central Emergency	Emergency lighting	Emergency flux	Type of emergency lighting battery
911401807687	RC132V G6 34S/830 PSU W60L60 OC	No	-	-	-
911401830488	RC132V G6 31_43S/840 PSU ELR IK03 60x60	No	Emergency lighting ready (through compatible battery kit accessory)	380 lm	-
911401890285	RC132V G6 36S/840 PSU W60L60 NOC	No	Emergency lighting ready (through compatible battery kit accessory)	380 lm	-
911401890885	RC132V G6 36S/840 PSD W60L60 OC	No	-	-	-
911401818787	RC132V G6 31_36_43S/840 PSU W60L60OCUKI	No	-	-	-
911401891185	RC132V G6 29_36_43S/ 830_40 PSU W60L60 OC	No	-	-	-
911401891285	RC132V G6 29_36_43S/ 830_40 PSD W60L60 OC	No	-	-	-
911401888487	RC132V G6 36S/ UE840 PSD 599x599SQ OC CPC	-	-	-	-

Emergency Operation (2/2)

CoreLine Panel gen6

Order Code	Full Product Name	Power consumption during Central DC emergency mode	Rated duration of the emergency lighting (when fully charged)
910505102802	RC132V G6 43S/840 SIA W60L60 OC IA4	-	-
911401801187	RC132V G6 29_36_43S/830_40 PSDW30L120OC	-	-
910505102819	RC132V G6 36S/840 PSU W30L120 OC ELB3	2 W	3 h
911401802887	RC132V G6 36S/840 WIA W30L120 OC	-	-
911401890785	RC132V G6 36S/840 PSU W30L120 OC	-	-
911401891085	RC132V G6 36S/840 PSD W30L120 OC	-	-
911401891685	RC132V G6 50S/940 PSU W60L60 NOC IP65	-	-
911401891785	RC132V G6 48S/940 PSU W60L60 OC IP65	-	-
911401891885	RC132V G6 48S/940 PSD W60L60 OC IP65	-	-
911401888287	RC132V G6 50S/840 PSU W60L120 OC	-	-
910505102816	RC132V G6 36S/840 PSU W60L60 OC ELB3	2 W	3 h
910505102817	RC132V G6 36S/840 PSD W60L60 OC ELB3	2 W	3 h

Order Code	Full Product Name	Power consumption during Central DC emergency mode	Rated duration of the emergency lighting (when fully charged)
911401800187	RC132V G6 36S/UE840 PSU W60L60 OC	-	-
911401800287	RC132V G6 36S/UE840 PSD W60L60 OC	-	-
911401802487	RC132V G6 43S/840 WIA W60L60 OC	-	-
911401807687	RC132V G6 34S/830 PSU W60L60 OC	-	-
911401830488	RC132V G6 31_43S/840 PSU ELR IK03 60x60	-	-
911401890285	RC132V G6 36S/840 PSU W60L60 NOC	-	-
911401890885	RC132V G6 36S/840 PSD W60L60 OC	-	-
911401818787	RC132V G6 31_36_43S/840 PSU W60L60OCUKI	-	-
911401891185	RC132V G6 29_36_43S/830_40 PSU W60L60 OC	-	-
911401891285	RC132V G6 29_36_43S/830_40 PSD W60L60 OC	-	-
911401888487	RC132V G6 36S/UE840 PSD 599x599SQ OC CPC	-	-

Approval and Application

Order Code	Full Product Name	Ambient temperature range	Flammability mark	Glow-wire test
910505102802	RC132V G6 43S/840 SIA W60L60 OC IA4	0°C to 35°C	-	Temperature 650 °C, duration 30 s
911401801187	RC132V G6 29_36_43S/830_40 PSDW30L120OC	-10 to +35 °C	For mounting on normally flammable surfaces	Temperature 650 °C, duration 30 s
910505102819	RC132V G6 36S/840 PSU W30L120 OC ELB3	0°C to 35°C	-	Temperature 850 °C, duration 30 s
911401802887	RC132V G6 36S/840 WIA W30L120 OC	-10 to +35 °C	For mounting on normally flammable surfaces	Temperature 650 °C, duration 30 s
911401890785	RC132V G6 36S/840 PSU W30L120 OC	-10 to +35 °C	For mounting on normally flammable surfaces	Temperature 650 °C, duration 30 s

Order Code	Full Product Name	Ambient temperature range	Flammability mark	Glow-wire test
911401891085	RC132V G6 36S/840 PSD W30L120 OC	-10 to +35 °C	For mounting on normally flammable surfaces	Temperature 650 °C, duration 30 s
911401891685	RC132V G6 50S/940 PSU W60L60 NOC IP65	-10 to +35 °C	For mounting on normally flammable surfaces	Temperature 650 °C, duration 30 s
911401891785	RC132V G6 48S/940 PSU W60L60 OC IP65	-10 to +35 °C	For mounting on normally flammable surfaces	Temperature 650 °C, duration 30 s
911401891885	RC132V G6 48S/940 PSD W60L60 OC IP65	-10 to +35 °C	For mounting on normally flammable surfaces	Temperature 650 °C, duration 30 s
911401888287	RC132V G6 50S/840 PSU W60L120 OC	-10 to +35 °C	For mounting on normally flammable surfaces	Temperature 650 °C, duration 30 s

CoreLine Panel gen6

Order Code	Full Product Name	Ambient temperature range	Flammability mark	Glow-wire test
			flammable surfaces	
910505102816	RC132V G6 36S/840 PSU W60L60 OC ELB3	0°C to 35°C	-	Temperature 850 °C, duration 30 s
910505102817	RC132V G6 36S/840 PSD W60L60 OC ELB3	0°C to 35°C	-	Temperature 850 °C, duration 30 s
911401800187	RC132V G6 36S/ UE840 PSU W60L60 OC	-10 to +35 °C	For mounting on normally flammable surfaces	Temperature 650 °C, duration 30 s
911401800287	RC132V G6 36S/ UE840 PSD W60L60 OC	-10 to +35 °C	For mounting on normally flammable surfaces	Temperature 650 °C, duration 30 s
911401802487	RC132V G6 43S/840 WIA W60L60 OC	-10 to +35 °C	For mounting on normally flammable surfaces	Temperature 650 °C, duration 30 s
911401807687	RC132V G6 34S/830 PSU W60L60 OC	-10 to +35 °C	For mounting on normally flammable surfaces	Temperature 650 °C, duration 30 s
911401830488	RC132V G6 31_43S/840 PSU ELR IK03 60x60	-10 to +35 °C	For mounting on normally flammable surfaces	Temperature 650 °C, duration 30 s

Order Code	Full Product Name	Ambient temperature range	Flammability mark	Glow-wire test
911401890285	RC132V G6 36S/840 PSU W60L60 NOC	-10 to +35 °C	For mounting on normally flammable surfaces	Temperature 650 °C, duration 30 s
911401890885	RC132V G6 36S/840 PSD W60L60 OC	-10 to +35 °C	For mounting on normally flammable surfaces	Temperature 650 °C, duration 30 s
911401818787	RC132V G6 31_36_43S/840 PSU W60L60OCUKI	-10 to +35 °C	For mounting on normally flammable surfaces	Temperature 650 °C, duration 30 s
911401891185	RC132V G6 29_36_43S/830_40 PSU W60L60 OC	-10 to +35 °C	For mounting on normally flammable surfaces	Temperature 650 °C, duration 30 s
911401891285	RC132V G6 29_36_43S/830_40 PSD W60L60 OC	-10 to +35 °C	For mounting on normally flammable surfaces	Temperature 650 °C, duration 30 s
911401888487	RC132V G6 36S/ UE840 PSD 599x599SQ OC CPC	-10 to +35 °C	For mounting on normally flammable surfaces	Temperature 650 °C, duration 30 s

Initial Performance (IEC Compliant)

Order Code	Full Product Name	Initial chromaticity
910505102802	RC132V G6 43S/840 SIA W60L60 OC IA4	(0.38, 0.38) SDCM ≤3
911401801187	RC132V G6 29_36_43S/830_40 PSDW30L120OC	(0.38, 0.38) SDCM ≤3
910505102819	RC132V G6 36S/840 PSU W30L120 OC ELB3	(0.38, 0.38) SDCM ≤3
911401802887	RC132V G6 36S/840 WIA W30L120 OC	(0.38, 0.38) SDCM ≤3
911401890785	RC132V G6 36S/840 PSU W30L120 OC	(0.38, 0.38) SDCM ≤3
911401891085	RC132V G6 36S/840 PSD W30L120 OC	(0.38, 0.38) SDCM ≤3
911401891685	RC132V G6 50S/940 PSU W60L60 NOC IP65	(0.38, 0.38) SDCM ≤3
911401891785	RC132V G6 48S/940 PSU W60L60 OC IP65	(0.38, 0.38) SDCM ≤3
911401891885	RC132V G6 48S/940 PSD W60L60 OC IP65	(0.38, 0.38) SDCM ≤3
911401888287	RC132V G6 60S/840 PSU W60L120 OC	(0.38, 0.38) SDCM ≤3
910505102816	RC132V G6 36S/840 PSU W60L60 OC ELB3	(0.38, 0.38) SDCM ≤3
910505102817	RC132V G6 36S/840 PSD W60L60 OC ELB3	(0.38, 0.38) SDCM ≤3

Order Code	Full Product Name	Initial chromaticity
911401800187	RC132V G6 36S/UE840 PSU W60L60 OC	(0.38, 0.38) SDCM ≤3
911401800287	RC132V G6 36S/UE840 PSD W60L60 OC	(0.38, 0.38) SDCM ≤3
911401802487	RC132V G6 43S/840 WIA W60L60 OC	(0.38, 0.38) SDCM ≤3
911401807687	RC132V G6 34S/830 PSU W60L60 OC	(0.43, 0.40) SDCM ≤3
911401830488	RC132V G6 31_43S/840 PSU ELR IK03 60x60	(0.38, 0.38) SDCM ≤3
911401890285	RC132V G6 36S/840 PSU W60L60 NOC	(0.38, 0.38) SDCM ≤3
911401890885	RC132V G6 36S/840 PSD W60L60 OC	(0.38, 0.38) SDCM ≤3
911401818787	RC132V G6 31_36_43S/840 PSU W60L60OCUKI	(0.38, 0.38) SDCM ≤3
911401891185	RC132V G6 29_36_43S/830_40 PSU W60L60 OC	(0.38, 0.38) SDCM ≤3
911401891285	RC132V G6 29_36_43S/830_40 PSD W60L60 OC	(0.38, 0.38) SDCM ≤3
911401888487	RC132V G6 36S/UE840 PSD 599x599SQ OC CPC	(0.38, 0.38) SDCM ≤3

Product Data

Order Code	Full Product Name	Product family code
910505102802	RC132V G6 43S/840 SIA W60L60 OC IA4	RC132V

Order Code	Full Product Name	Product family code
911401801187	RC132V G6 29_36_43S/830_40 PSDW30L120OC	-

CoreLine Panel gen6

Order Code	Full Product Name	Product family code	Order Code	Full Product Name	Product family code
910505102819	RC132V G6 36S/840 PSU W30L120 OC ELB3	RC132V	911401800287	RC132V G6 36S/UE840 PSD W60L60 OC	-
911401802887	RC132V G6 36S/840 WIA W30L120 OC	-	911401802487	RC132V G6 43S/840 WIA W60L60 OC	-
911401890785	RC132V G6 36S/840 PSU W30L120 OC	-	911401807687	RC132V G6 34S/830 PSU W60L60 OC	-
911401891085	RC132V G6 36S/840 PSD W30L120 OC	-	911401830488	RC132V G6 31_43S/840 PSU ELR IK03 60x60	-
911401891685	RC132V G6 50S/940 PSU W60L60 NOC IP65	-	911401890285	RC132V G6 36S/840 PSU W60L60 NOC	-
911401891785	RC132V G6 48S/940 PSU W60L60 OC IP65	-	911401890885	RC132V G6 36S/840 PSD W60L60 OC	-
911401891885	RC132V G6 48S/940 PSD W60L60 OC IP65	-	911401818787	RC132V G6 31_36_43S/840 PSU W60L60OCUKI	-
911401888287	RC132V 60S/840 PSU W60L120 OC	-	911401891185	RC132V G6 29_36_43S/830_40 PSU W60L60 OC	-
910505102816	RC132V G6 36S/840 PSU W60L60 OC ELB3	RC132V	911401891285	RC132V G6 29_36_43S/830_40 PSD W60L60 OC	-
910505102817	RC132V G6 36S/840 PSD W60L60 OC ELB3	RC132V	911401888487	RC132V G6 36S/UE840 PSD 599x599SQ OC CPC	-
911401800187	RC132V G6 36S/UE840 PSU W60L60 OC	-			

Polar Wide Diagrams

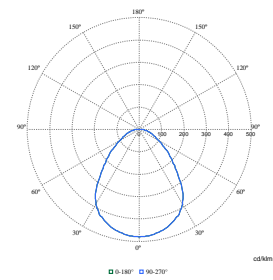
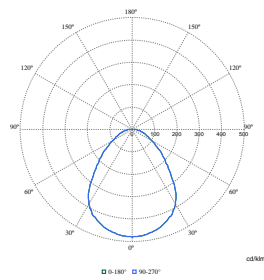
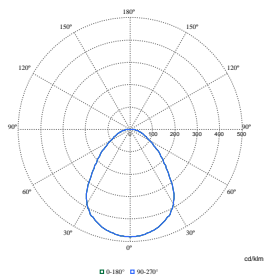

Polar Normal (separate) - RC132VI - 910505102817

Polar Normal (separate) - RC132VI - 910505102819

Polar Normal (separate) - RC132VI - 910505102802

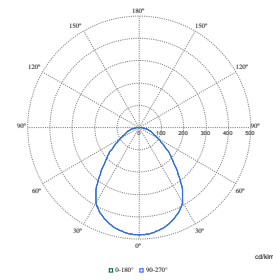
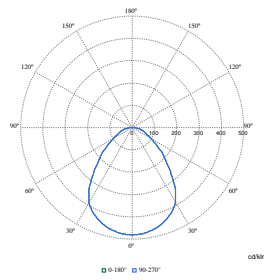
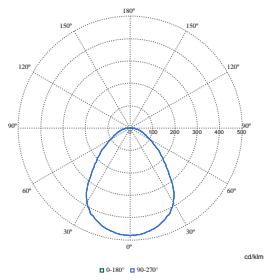

Polar Normal (separate) - RC132VI - 910505102816

Polar Normal (separate) - 911401891085

Polar Normal (separate) - 911401890785

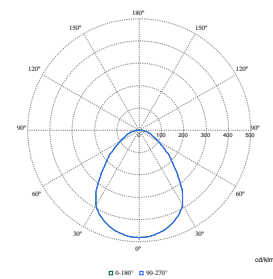
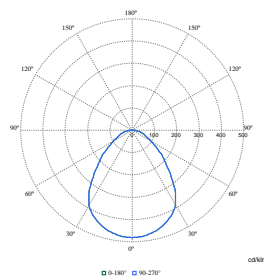

Polar Normal (separate) - 911401890885

Polar Normal (separate) - 911401891285

CoreLine Panel gen6

Polar Wide Diagrams

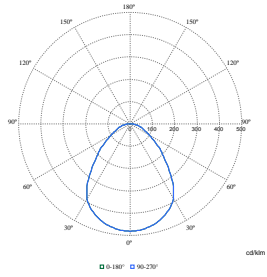

Polar Normal (separate) - 911401888487

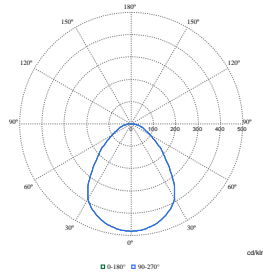

Polar Normal (separate) - 911401888287

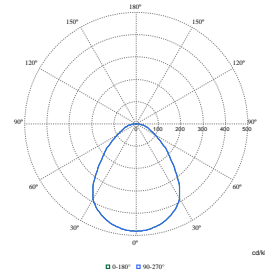

Polar Normal (separate) - 911401830488

