



# The perfect replacement for mains voltage halogen spots

## MASTER VALUE LED spot MV

Delivering a warm, halogen-like accent beam, the MASTER VALUE is a perfect fit for spot lighting. Thanks to its high CRI, it achieves more natural colours, creating cosy and comfortable ambience for residential and hospitality projects, and emphasising the beauty of merchandise in retail. These LED spots MV GU10 have the familiar look and feel of spot lamps, keeping the classic beauty of glass spots and adding the strong performance of LED technology. The dimming function enables you to create the atmosphere you desire, and it works with broad selection of dimmers. The MASTER VALUE also offers more energy savings than normal LED spots.

### Benefits

- With MASTER VALUE spotlight, up to 80% energy saving compared with halogen lamps
- Best mimic of a halogen spot for atmosphere creation
- Perfect replacement for traditional GU10 lamps

### Features

- Dimmable range
- Compatible with an extensive range of dimmers
- Patented intelligent driver
- Lifetime of 25,000 hours
- No UV and Cool Beam (no IR), making it suitable for illuminating heat-sensitive objects (food, organic materials, paintings etc.)

### Application

- Hospitality
- Retail
- Residential

## MASTER VALUE LED spot MV

### Warnings and Safety

- Operating temperature range is between -20° C and 45° C ambient
- Only to apply in dry or damp locations and most of open fixtures with lamp-holders that offer sufficient space (10 mm free air space)
- Not intended for use with emergency light fixtures or exit lights

### Versions



MASTER LEDspotMV 35W GU10 36D

# MASTER VALUE LED spot MV

## Dimensional drawing

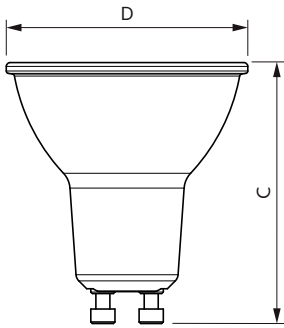
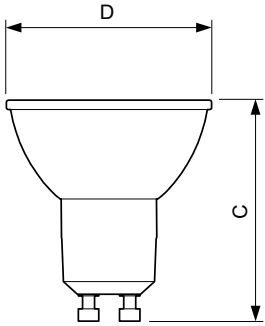

Product	D	C
MAS LED spot VLE D 3.7-35W GU10 930 36D	50 mm	54 mm
MAS LED spot VLE D 650lm GU10 930 120D	50 mm	54 mm
MAS LED spot VLEDT4.9-50W GU10 927 36DUK	50 mm	54 mm

Product	D	C
MAS LED spot VLE D 2.8-35W GU10 927 36D	50 mm	54 mm
MAS LED spot VLE D 2.8-35W GU10 927 60D	50 mm	54 mm
MAS LED spot VLE D 2.8-35W GU10 930 36D	50 mm	54 mm
MAS LED spot VLE D 2.8-35W GU10 940 36D	50 mm	54 mm
MAS LED spot VLE D 3.7-50W GU10 927 36D	50 mm	54 mm
MAS LED spot VLE D 3.7-50W GU10 927 60D	50 mm	54 mm
MAS LED spot VLE D 3.7-50W GU10 930 36D	50 mm	54 mm
MAS LED spot VLE D 3.7-50W GU10 930 60D	50 mm	54 mm
MAS LED spot VLE D 3.7-50W GU10 940 36D	50 mm	54 mm
MAS LED spot VLE D 3.7-50W GU10 940 60D	50 mm	54 mm
MAS LED spot VLE D 5.5-80W GU10 940 36D	50 mm	54 mm
MAS LED spot VLE D 5.5-80W GU10 965 36D	50 mm	54 mm
MAS LED spot VLE D 650lm GU10 930 120D	50 mm	55.5 mm
MAS LED spot VLE D 680lm GU10 940 120D	50 mm	55.5 mm
MAS LED spot VLE D 680lm GU10 965 120D	50 mm	55.5 mm
MAS LED spot VLE DT 2.8-35W GU10 927 36D	50 mm	54 mm
MAS LED spot VLEDT3.7-50W GU10 927 36DUK	50 mm	54 mm
MAS LEDspotVLE D 3.7-50W GU10 930 36D UK	50 mm	54 mm
MAS LEDspotVLE D 3.7-50W GU10 940 36D UK	50 mm	54 mm
MASLEDspot VLE D 5.5-80W GU10 927 36D UK	50 mm	54 mm
MASLEDspot VLE D 5.5-80W GU10 930 36D UK	50 mm	54 mm
MASLEDspot VLE D 5.5-80W GU10 940 36D UK	50 mm	54 mm

# MASTER VALUE LED spot MV

General Information	
Cap base	GU10
Nominal lifetime	25,000 h
Light Technical	
Colour rendering index (CRI)	90
LLMF at end of nominal lifetime (nom.)	70 %
Operating and Electrical	
Input frequency	50 to 60 Hz
Starting time (nom.)	0.5 s
Controls and Dimming	
Dimmable	Only with specific dimmers
Mechanical and Housing	
Bulb shape	PAR16

## General Information

Order Code	Full Product Name	Switching Cycle
929004255899	MASLEDspot VLE D 5.5-80W GU10 927 36D UK	50,000
929004255999	MASLEDspot VLE D 5.5-80W GU10 930 36D UK	50,000
929004256002	MAS LED spot VLE D 5.5-80W GU10 940 36D	50,000
929004256099	MASLEDspot VLE D 5.5-80W GU10 940 36D UK	50,000
929004256102	MAS LED spot VLE D 5.5-80W GU10 965 36D	50,000
929001348302	MAS LED spot VLE D 3.7-35W GU10 930 36D	50,000
929001350399	MAS LED spot VLEDT4.9-50W GU10 927 36DUK	50,000
929004247102	MAS LED spot VLE DT 2.8-35W GU10 927 36D	50,000
929004247299	MAS LED spot VLEDT3.7-50W GU10 927 36DUK	50,000
929004247302	MAS LED spot VLE D 2.8-35W GU10 927 36D	50,000
929004247402	MAS LED spot VLE D 2.8-35W GU10 930 36D	50,000
929004247502	MAS LED spot VLE D 2.8-35W GU10 940 36D	50,000
929004247602	MAS LED spot VLE D 2.8-35W GU10 927 60D	50,000
929004247902	MAS LED spot VLE D 3.7-50W GU10 927 36D	50,000
929004248002	MAS LED spot VLE D 3.7-50W GU10 930 36D	50,000
929004248098	MAS LEDspotVLE D 3.7-50W GU10 930 36D UK	50,000
929004248102	MAS LED spot VLE D 3.7-50W GU10 940 36D	50,000
929004248199	MAS LEDspotVLE D 3.7-50W GU10 940 36D UK	50,000
929004248202	MAS LED spot VLE D 3.7-50W GU10 927 60D	25,000
929004248302	MAS LED spot VLE D 3.7-50W GU10 930 60D	25,000
929004248402	MAS LED spot VLE D 3.7-50W GU10 940 60D	25,000
929002210002	MAS LED spot VLE D 650lm GU10 930 120D	50,000
929004256202	MAS LED spot VLE D 650lm GU10 930 120D	50,000
929004256302	MAS LED spot VLE D 680lm GU10 940 120D	50,000
929004256402	MAS LED spot VLE D 680lm GU10 965 120D	50,000

## Light Technical (1/2)

Order Code	Full Product Name	Beam angle (nom.)	Correlated		
			Colour Temperature (Nom)	Colour Code	Luminous Flux
929004255899	MASLEDspot VLE D 5.5-80W GU10 927 36D UK	36 degree(s)	2700 K	927	575 lm
929004255999	MASLEDspot VLE D 5.5-80W GU10 930 36D UK	36 degree(s)	3000 K	930	575 lm
929004256002	MAS LED spot VLE D 5.5-80W GU10 940 36D	36 degree(s)	4000 K	940	575 lm
929004256099	MASLEDspot VLE D 5.5-80W GU10 940 36D UK	36 degree(s)	4000 K	940	575 lm
929004256102	MAS LED spot VLE D 5.5-80W GU10 965 36D	36 degree(s)	6500 K	965	575 lm
929001348302	MAS LED spot VLE D 3.7-35W GU10 930 36D	36 degree(s)	3000 K	930	270 lm

Order Code	Full Product Name	Beam angle (nom.)	Correlated		
			Colour Temperature (Nom)	Colour Code	Luminous Flux
929001350399	MAS LED spot VLEDT4.9-50W GU10 927 36DUK	36 degree(s)	2200 K	922-927	355 lm
929004247102	MAS LED spot VLE DT 2.8-35W GU10 927 36D	36 degree(s)	2200 K	922-927	280 lm
929004247299	MAS LED spot VLEDT3.7-50W GU10 927 36DUK	36 degree(s)	2200 K	922-927	355 lm
929004247302	MAS LED spot VLE D 2.8-35W GU10 927 36D	36 degree(s)	2700 K	927	270 lm
929004247402	MAS LED spot VLE D 2.8-35W GU10 930 36D	36 degree(s)	3000 K	930	270 lm
929004247502	MAS LED spot VLE D 2.8-35W GU10 940 36D	36 degree(s)	4000 K	940	285 lm

## MASTER VALUE LED spot MV

Order Code	Full Product Name	Beam angle (nom.)	Correlated Colour		
			Temperature (Nom)	Colour Code	Luminous Flux
929004247602	MAS LED spot VLE D 2.8-35W GU10 927 60D	60 degree(s)	2700 K	927	270 lm
929004247902	MAS LED spot VLE D 3.7-50W GU10 927 36D	36 degree(s)	2700 K	927	355 lm
929004248002	MAS LED spot VLE D 3.7-50W GU10 930 36D	36 degree(s)	3000 K	930	365 lm
929004248098	MAS LEDspotVLE D 3.7-50W GU10 930 36D UK	36 degree(s)	3000 K	930	365 lm
929004248102	MAS LED spot VLE D 3.7-50W GU10 940 36D	36 degree(s)	4000 K	940	380 lm
929004248199	MAS LEDspotVLE D 3.7-50W GU10 940 36D UK	36 degree(s)	4000 K	940	380 lm
929004248202	MAS LED spot VLE D 3.7-50W GU10 927 60D	60 degree(s)	2700 K	927	355 lm

Order Code	Full Product Name	Beam angle (nom.)	Correlated Colour		
			Temperature (Nom)	Colour Code	Luminous Flux
929004248302	MAS LED spot VLE D 3.7-50W GU10 930 60D	60 degree(s)	3000 K	930	365 lm
929004248402	MAS LED spot VLE D 3.7-50W GU10 940 60D	60 degree(s)	4000 K	940	370 lm
929002210002	MAS LED spot VLE D 650lm GU10 930 120D	120 degree(s)	3000 K	930	650 lm
929004256202	MAS LED spot VLE D 650lm GU10 930 120D	120 degree(s)	3000 K	930	650 lm
929004256302	MAS LED spot VLE D 680lm GU10 940 120D	120 degree(s)	4000 K	940	680 lm
929004256402	MAS LED spot VLE D 680lm GU10 965 120D	120 degree(s)	6500 K	965	680 lm

### Light Technical (2/2)

Order Code	Full Product Name	Luminous intensity (nom.)
929004255899	MASLEDspot VLE D 5.5-80W GU10 927 36D UK	950 cd
929004255999	MASLEDspot VLE D 5.5-80W GU10 930 36D UK	1,000 cd
929004256002	MAS LED spot VLE D 5.5-80W GU10 940 36D	1,000 cd
929004256099	MASLEDspot VLE D 5.5-80W GU10 940 36D UK	1,000 cd
929004256102	MAS LED spot VLE D 5.5-80W GU10 965 36D	1,000 cd
929001348302	MAS LED spot VLE D 3.7-35W GU10 930 36D	500 cd
929001350399	MAS LED spot VLEDT4.9-50W GU10 927 36DUK	650 cd
929004247102	MAS LED spot VLE DT 2.8-35W GU10 927 36D	550 cd
929004247299	MAS LED spot VLEDT3.7-50W GU10 927 36DUK	700 cd
929004247302	MAS LED spot VLE D 2.8-35W GU10 927 36D	600 cd
929004247402	MAS LED spot VLE D 2.8-35W GU10 930 36D	600 cd
929004247502	MAS LED spot VLE D 2.8-35W GU10 940 36D	600 cd
929004247602	MAS LED spot VLE D 2.8-35W GU10 927 60D	300 cd

Order Code	Full Product Name	Luminous intensity (nom.)
929004247902	MAS LED spot VLE D 3.7-50W GU10 927 36D	750 cd
929004248002	MAS LED spot VLE D 3.7-50W GU10 930 36D	750 cd
929004248098	MAS LEDspotVLE D 3.7-50W GU10 930 36D UK	750 cd
929004248102	MAS LED spot VLE D 3.7-50W GU10 940 36D	800 cd
929004248199	MAS LEDspotVLE D 3.7-50W GU10 940 36D UK	800 cd
929004248202	MAS LED spot VLE D 3.7-50W GU10 927 60D	400 cd
929004248302	MAS LED spot VLE D 3.7-50W GU10 930 60D	400 cd
929004248402	MAS LED spot VLE D 3.7-50W GU10 940 60D	420 cd
929002210002	MAS LED spot VLE D 650lm GU10 930 120D	200 cd
929004256202	MAS LED spot VLE D 650lm GU10 930 120D	220 cd
929004256302	MAS LED spot VLE D 680lm GU10 940 120D	220 cd
929004256402	MAS LED spot VLE D 680lm GU10 965 120D	220 cd

### Operating and Electrical

Order Code	Full Product Name	Line Frequency	Power Consumption	Wattage equivalent
929004255899	MASLEDspot VLE D 5.5-80W GU10 927 36D UK	-	5.5 W	80 W

Order Code	Full Product Name	Line Frequency	Power Consumption	Wattage equivalent
929004255999	MASLEDspot VLE D 5.5-80W GU10 930 36D UK	-	5.5 W	80 W

## MASTER VALUE LED spot MV

Order Code	Full Product Name	Line Frequency	Power Consumption	Wattage equivalent
929004256002	MAS LED spot VLE D 5.5-80W GU10 940 36D	-	5.5 W	80 W
929004256099	MASLEDspot VLE D 5.5-80W GU10 940 36D UK	-	5.5 W	80 W
929004256102	MAS LED spot VLE D 5.5-80W GU10 965 36D	-	5.5 W	80 W
929001348302	MAS LED spot VLE D 3.7-35W GU10 930 36D	50 to 60 Hz	3.7 W	35 W
929001350399	MAS LED spot VLEDT4.9-50W GU10 927 36DUK	50 to 60 Hz	4.9 W	50 W
929004247102	MAS LED spot VLE DT 2.8-35W GU10 927 36D	-	2.8 W	35 W
929004247299	MAS LED spot VLEDT3.7-50W GU10 927 36DUK	-	3.7 W	50 W
929004247302	MAS LED spot VLE D 2.8-35W GU10 927 36D	-	2.8 W	35 W
929004247402	MAS LED spot VLE D 2.8-35W GU10 930 36D	-	2.8 W	35 W
929004247502	MAS LED spot VLE D 2.8-35W GU10 940 36D	-	2.8 W	35 W
929004247602	MAS LED spot VLE D 2.8-35W GU10 927 60D	-	2.8 W	35 W
929004247902	MAS LED spot VLE D 3.7-50W GU10 927 36D	-	3.7 W	50 W

Order Code	Full Product Name	Line Frequency	Power Consumption	Wattage equivalent
929004248002	MAS LED spot VLE D 3.7-50W GU10 930 36D	-	3.7 W	50 W
929004248098	MAS LEDspotVLE D 3.7-50W GU10 930 36D UK	-	3.7 W	50 W
929004248102	MAS LED spot VLE D 3.7-50W GU10 940 36D	-	3.7 W	50 W
929004248199	MAS LEDspotVLE D 3.7-50W GU10 940 36D UK	-	3.7 W	50 W
929004248202	MAS LED spot VLE D 3.7-50W GU10 927 60D	-	3.7 W	50 W
929004248302	MAS LED spot VLE D 3.7-50W GU10 930 60D	-	3.7 W	50 W
929004248402	MAS LED spot VLE D 3.7-50W GU10 940 60D	-	3.7 W	50 W
929002210002	MAS LED spot VLE D 650lm GU10 930 120D	50 to 60 Hz	6.2 W	-
929004256202	MAS LED spot VLE D 650lm GU10 930 120D	-	5.5 W	-
929004256302	MAS LED spot VLE D 680lm GU10 940 120D	-	5.5 W	-
929004256402	MAS LED spot VLE D 680lm GU10 965 120D	-	5.5 W	-

### Temperature

Order Code	Full Product Name	T-Case maximum (nom.)
929004255899	MASLEDspot VLE D 5.5-80W GU10 927 36D UK	66 °C
929004255999	MASLEDspot VLE D 5.5-80W GU10 930 36D UK	66 °C
929004256002	MAS LED spot VLE D 5.5-80W GU10 940 36D	66 °C
929004256099	MASLEDspot VLE D 5.5-80W GU10 940 36D UK	66 °C
929004256102	MAS LED spot VLE D 5.5-80W GU10 965 36D	66 °C
929001348302	MAS LED spot VLE D 3.7-35W GU10 930 36D	80 °C
929001350399	MAS LED spot VLEDT4.9-50W GU10 927 36DUK	65 °C
929004247102	MAS LED spot VLE DT 2.8-35W GU10 927 36D	52 °C
929004247299	MAS LED spot VLEDT3.7-50W GU10 927 36DUK	60 °C
929004247302	MAS LED spot VLE D 2.8-35W GU10 927 36D	50 °C
929004247402	MAS LED spot VLE D 2.8-35W GU10 930 36D	50 °C
929004247502	MAS LED spot VLE D 2.8-35W GU10 940 36D	50 °C
929004247602	MAS LED spot VLE D 2.8-35W GU10 927 60D	50 °C

Order Code	Full Product Name	T-Case maximum (nom.)
929004247902	MAS LED spot VLE D 3.7-50W GU10 927 36D	66 °C
929004248002	MAS LED spot VLE D 3.7-50W GU10 930 36D	66 °C
929004248098	MAS LEDspotVLE D 3.7-50W GU10 930 36D UK	66 °C
929004248102	MAS LED spot VLE D 3.7-50W GU10 940 36D	66 °C
929004248199	MAS LEDspotVLE D 3.7-50W GU10 940 36D UK	66 °C
929004248202	MAS LED spot VLE D 3.7-50W GU10 927 60D	62 °C
929004248302	MAS LED spot VLE D 3.7-50W GU10 930 60D	62 °C
929004248402	MAS LED spot VLE D 3.7-50W GU10 940 60D	62 °C
929002210002	MAS LED spot VLE D 650lm GU10 930 120D	80 °C
929004256202	MAS LED spot VLE D 650lm GU10 930 120D	66 °C
929004256302	MAS LED spot VLE D 680lm GU10 940 120D	66 °C
929004256402	MAS LED spot VLE D 680lm GU10 965 120D	66 °C

### Mechanical and Housing

Order Code	Full Product Name	Lamp Finish
929004255899	MASLEDspot VLE D 5.5-80W GU10 927 36D UK	Clear

Order Code	Full Product Name	Lamp Finish
929004255999	MASLEDspot VLE D 5.5-80W GU10 930 36D UK	Clear

# MASTER VALUE LED spot MV

Order Code	Full Product Name	Lamp Finish
929004256002	MAS LED spot VLE D 5.5-80W GU10 940 36D	Clear
929004256099	MASLEDspot VLE D 5.5-80W GU10 940 36D UK	Clear
929004256102	MAS LED spot VLE D 5.5-80W GU10 965 36D	Clear
929001348302	MAS LED spot VLE D 3.7-35W GU10 930 36D	-
929001350399	MAS LED spot VLEDT4.9-50W GU10 927 36DUK	-
929004247102	MAS LED spot VLE DT 2.8-35W GU10 927 36D	Clear
929004247299	MAS LED spot VLEDT3.7-50W GU10 927 36DUK	Clear
929004247302	MAS LED spot VLE D 2.8-35W GU10 927 36D	Clear
929004247402	MAS LED spot VLE D 2.8-35W GU10 930 36D	Clear
929004247502	MAS LED spot VLE D 2.8-35W GU10 940 36D	Clear
929004247602	MAS LED spot VLE D 2.8-35W GU10 927 60D	Clear
929004247902	MAS LED spot VLE D 3.7-50W GU10 927 36D	Clear

Order Code	Full Product Name	Lamp Finish
929004248002	MAS LED spot VLE D 3.7-50W GU10 930 36D	Clear
929004248098	MAS LEDspotVLE D 3.7-50W GU10 930 36D UK	Clear
929004248102	MAS LED spot VLE D 3.7-50W GU10 940 36D	Clear
929004248199	MAS LEDspotVLE D 3.7-50W GU10 940 36D UK	Clear
929004248202	MAS LED spot VLE D 3.7-50W GU10 927 60D	Clear
929004248302	MAS LED spot VLE D 3.7-50W GU10 930 60D	Clear
929004248402	MAS LED spot VLE D 3.7-50W GU10 940 60D	Clear
929002210002	MAS LED spot VLE D 650lm GU10 930 120D	-
929004256202	MAS LED spot VLE D 650lm GU10 930 120D	Frosted
929004256302	MAS LED spot VLE D 680lm GU10 940 120D	Frosted
929004256402	MAS LED spot VLE D 680lm GU10 965 120D	Frosted

## Approval and Application

Order Code	Full Product Name	Ambient temperature range	Energy consumption kWh/1,000 hours
929004255899	MASLEDspot VLE D 5.5-80W GU10 927 36D UK	-20 to +45 °C	6 kWh
929004255999	MASLEDspot VLE D 5.5-80W GU10 930 36D UK	-20 to +45 °C	6 kWh
929004256002	MAS LED spot VLE D 5.5-80W GU10 940 36D	-20 to +45 °C	6 kWh
929004256099	MASLEDspot VLE D 5.5-80W GU10 940 36D UK	-20 to +45 °C	6 kWh
929004256102	MAS LED spot VLE D 5.5-80W GU10 965 36D	-20 to +45 °C	6 kWh
929001348302	MAS LED spot VLE D 3.7-35W GU10 930 36D	-	4 kWh
929001350399	MAS LED spot VLEDT4.9-50W GU10 927 36DUK	-	5 kWh
929004247102	MAS LED spot VLE DT 2.8-35W GU10 927 36D	-20 to +45 °C	3 kWh
929004247299	MAS LED spot VLEDT3.7-50W GU10 927 36DUK	-20 to +45 °C	4 kWh
929004247302	MAS LED spot VLE D 2.8-35W GU10 927 36D	-20 to +45 °C	3 kWh
929004247402	MAS LED spot VLE D 2.8-35W GU10 930 36D	-20 to +45 °C	3 kWh
929004247502	MAS LED spot VLE D 2.8-35W GU10 940 36D	-20 to +45 °C	3 kWh
929004247602	MAS LED spot VLE D 2.8-35W GU10 927 60D	-20 to +45 °C	3 kWh
929004247902	MAS LED spot VLE D 3.7-50W GU10 927 36D	-20 to +45 °C	4 kWh
929004248002	MAS LED spot VLE D 3.7-50W GU10 930 36D	-20 to +45 °C	4 kWh
929004248098	MAS LEDspotVLE D 3.7-50W GU10 930 36D UK	-20 to +45 °C	4 kWh

Order Code	Full Product Name	Ambient temperature range	Energy consumption kWh/1,000 hours
929004248102	MAS LED spot VLE D 3.7-50W GU10 940 36D	-20 to +45 °C	4 kWh
929004248199	MAS LEDspotVLE D 3.7-50W GU10 940 36D UK	-20 to +45 °C	4 kWh
929004248202	MAS LED spot VLE D 3.7-50W GU10 927 60D	-20 to +45 °C	4 kWh
929004248302	MAS LED spot VLE D 3.7-50W GU10 930 60D	-20 to +45 °C	4 kWh
929004248402	MAS LED spot VLE D 3.7-50W GU10 940 60D	-20 to +45 °C	4 kWh
929002210002	MAS LED spot VLE D 650lm GU10 930 120D	-20 to +45 °C	7 kWh
929004256202	MAS LED spot VLE D 650lm GU10 930 120D	-20 to +45 °C	6 kWh
929004256302	MAS LED spot VLE D 680lm GU10 940 120D	-20 to +45 °C	6 kWh
929004256402	MAS LED spot VLE D 680lm GU10 965 120D	-20 to +45 °C	6 kWh

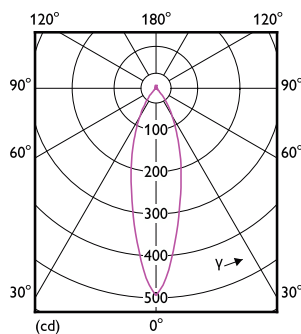

# MASTER VALUE LED spot MV

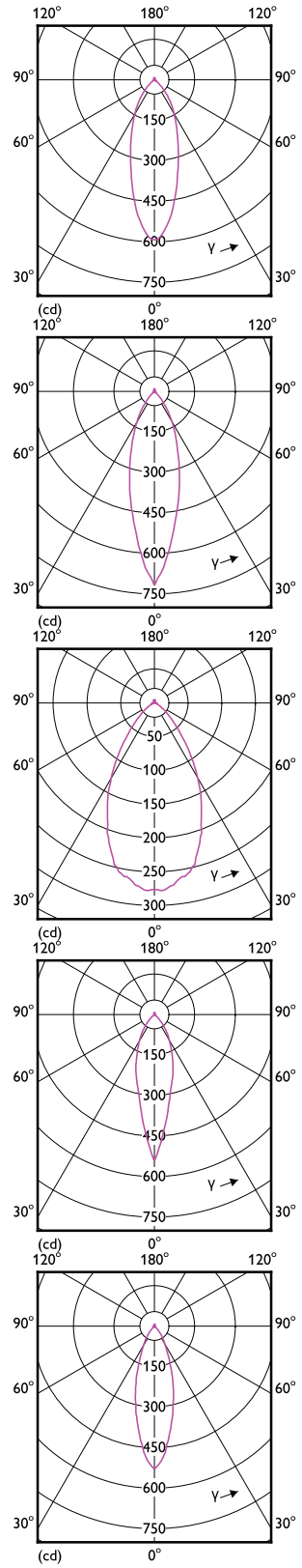
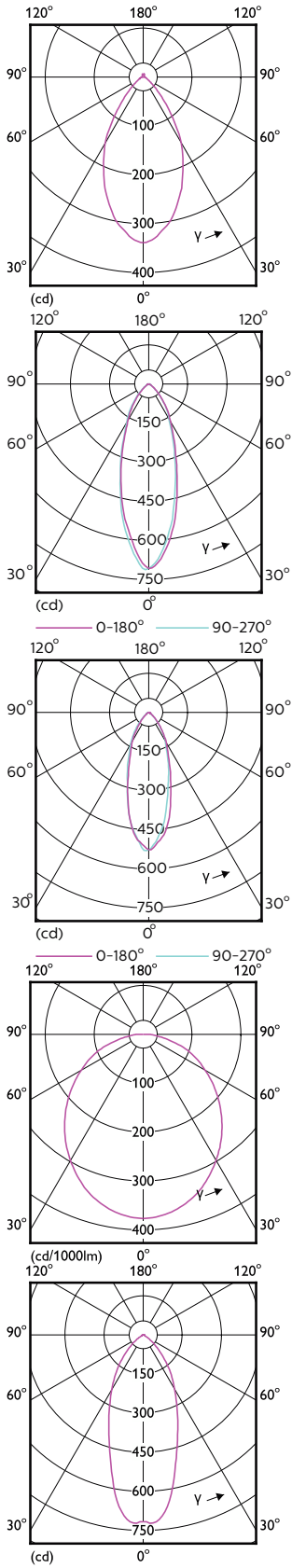

# MASTER VALUE LED spot MV

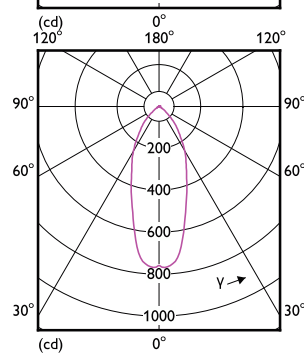
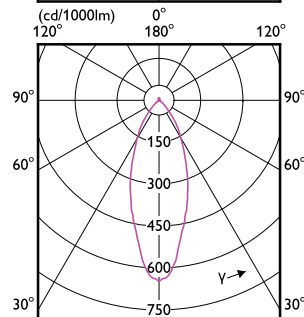
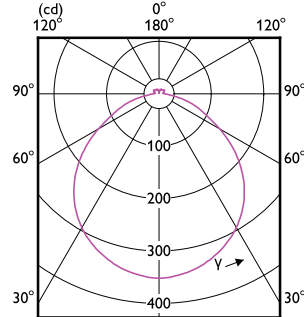
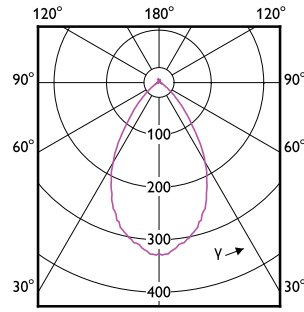
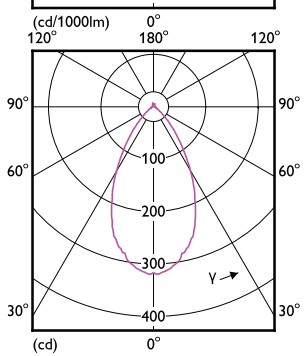
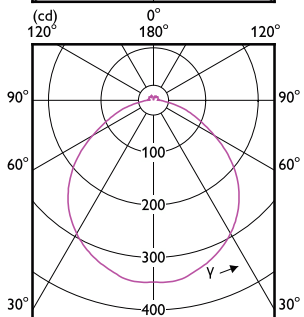
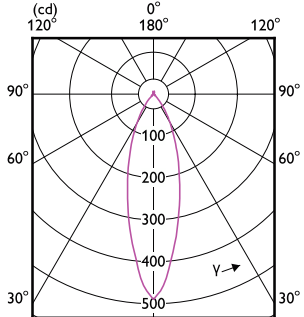
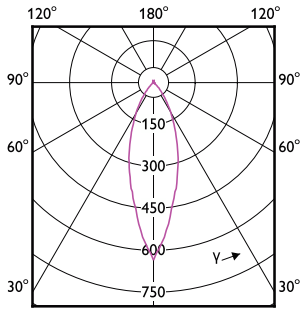

# MASTER VALUE LED spot MV

## Accent Diagrams

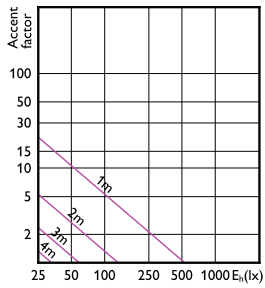

Accent Diagram - MAS LED spot VLE D 2.8-35W GU10 930 36D

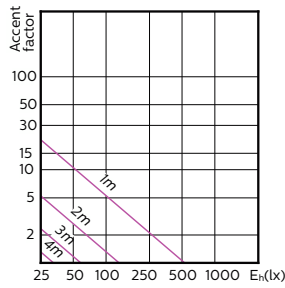

Accent Diagram - MAS LED spot VLEDT4.9-50W GU10 927 36DUK

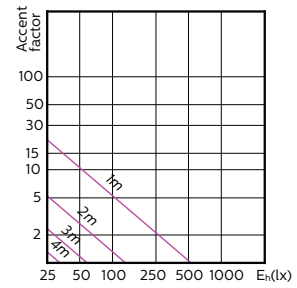

Accent Diagram - MAS LED spot VLE D 3.7-35W GU10 930 36D

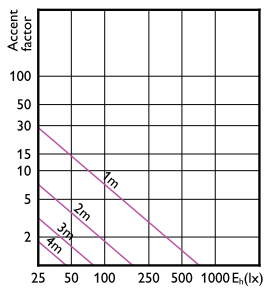

Accent Diagram - MAS LED spot VLE D 5.5-80W GU10 927 36D UK

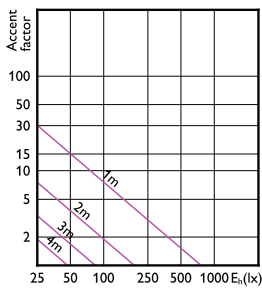

Accent Diagram - MAS LED spot VLE D 5.5-80W GU10 940 36D

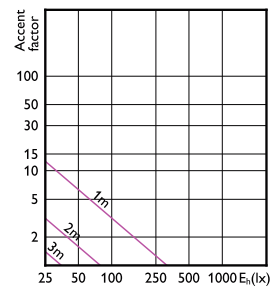

Accent Diagram - MAS LED spot VLE D 3.7-50W GU10 927 60D

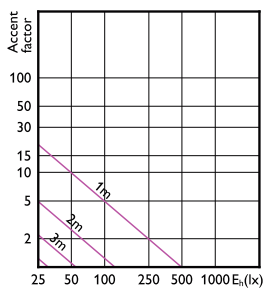

Accent Diagram - MAS LED spot VLE D 2.8-35W GU10 940 36D

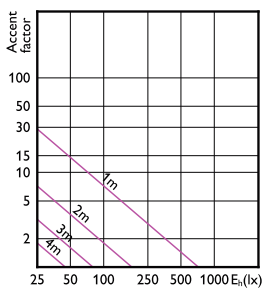

Accent Diagram - MAS LED spot VLE D 3.7-50W GU10 940 36D UK

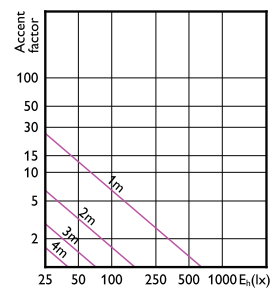

Accent Diagram - MAS LED spot VLE D 3.7-50W GU10 930 36D UK

# MASTER VALUE LED spot MV

## Accent Diagrams

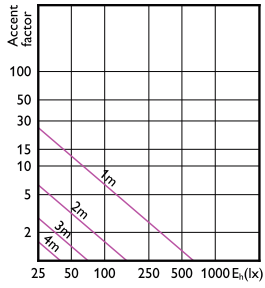

Accent Diagram - MAS LED spot VLE D 3.7-50W  
GU10 927 36D

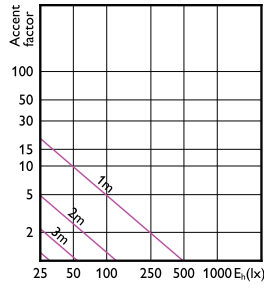

Accent Diagram - MAS LED spot VLE D 2.8-35W  
GU10 927 36D

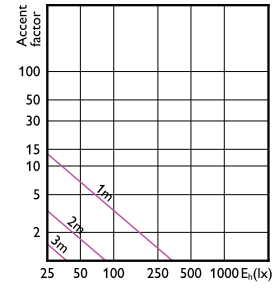

Accent Diagram - MAS LED spot VLE D 3.7-50W  
GU10 940 60D

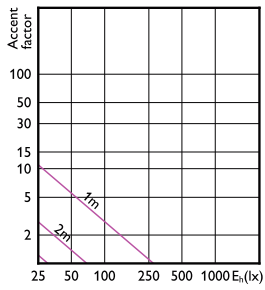

Accent Diagram - MAS LED spot VLE D 2.8-35W  
GU10 927 60D

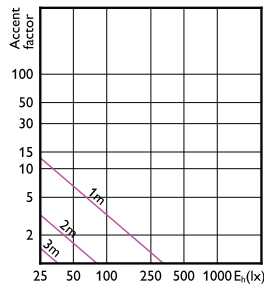

Accent Diagram - MAS LED spot VLE D 3.7-50W  
GU10 930 60D

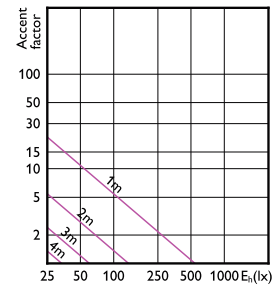

Accent Diagram - MAS LED spot VLE DT  
2.8-35W GU10 927 36D

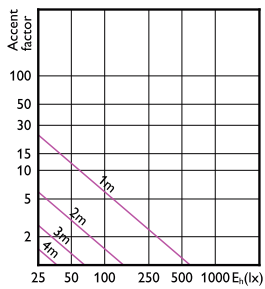

Accent Diagram - MAS LED spot VLEDT3.7-50W  
GU10 927 36DUK

# MASTER VALUE LED spot MV

## Beam Diagrams

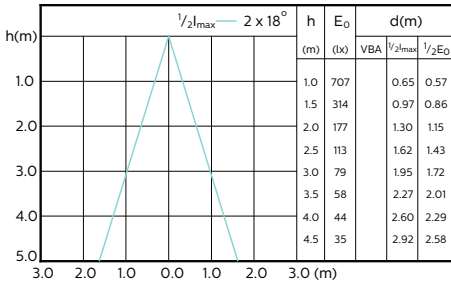

Beam diagram - MAS LED spot VLEDT4.9-50W  
GU10 927 36DUK

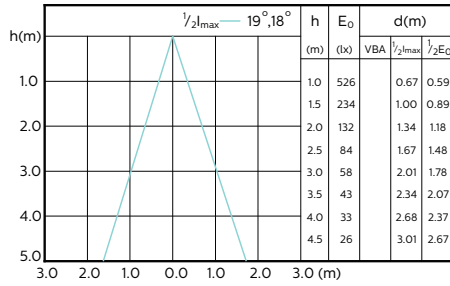

Beam diagram - MAS LED spot VLE D 3.7-35W  
GU10 930 36D

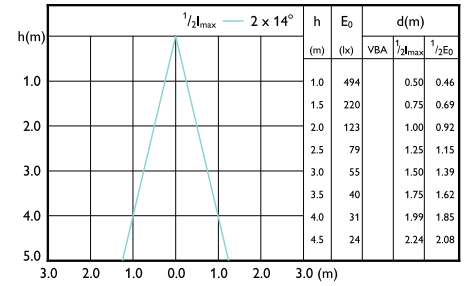

Beam diagram - MAS LED spot VLE D 2.8-35W  
GU10 940 36D

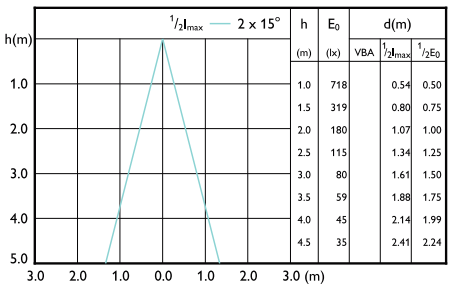

Beam diagram - MAS LEDspotVLE D 3.7-50W  
GU10 940 36D UK

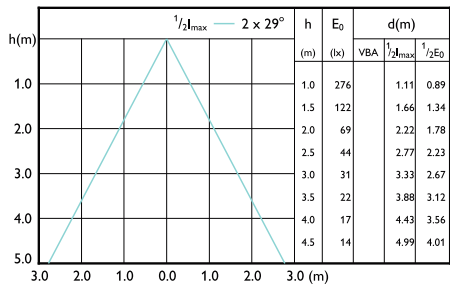

Beam diagram - MAS LED spot VLE D 2.8-35W  
GU10 927 60D

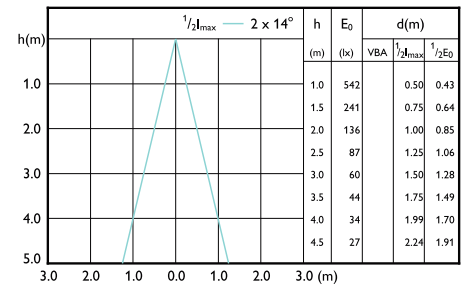

Beam diagram - MAS LED spot VLE DT 2.8-35W  
GU10 927 36D

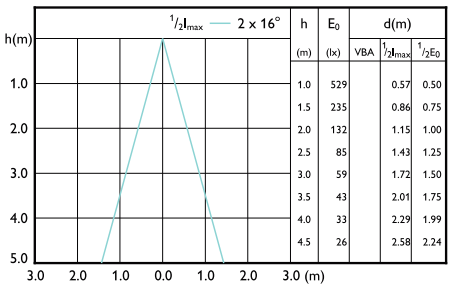

Beam diagram - MAS LED spot VLE D 2.8-35W  
GU10 930 36D

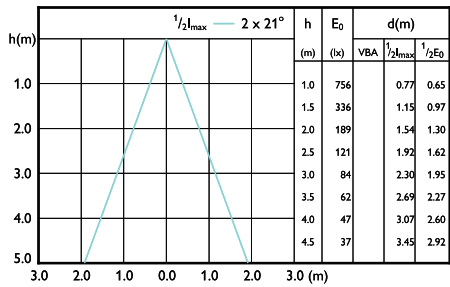

Beam diagram - MAS LED spot VLE D 5.5-80W  
GU10 940 36D

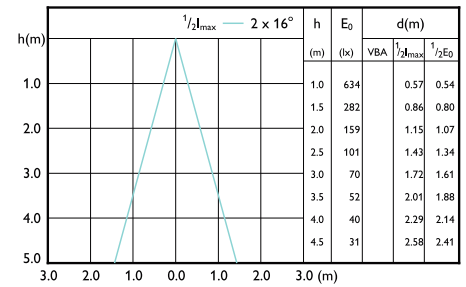

Beam diagram - MAS LED spot VLE D 3.7-50W  
GU10 927 36D

# MASTER VALUE LED spot MV

## Beam Diagrams

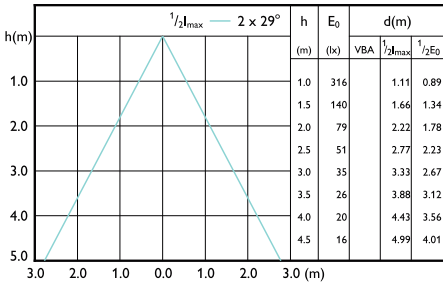

Beam diagram - MAS LED spot VLE D 3.7-50W  
GU10 927 60D

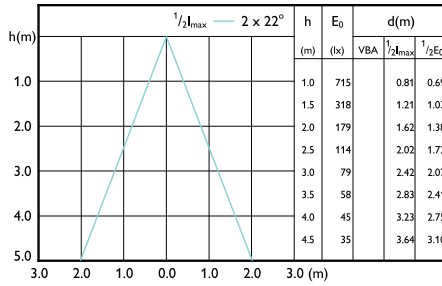

Beam diagram - MAS LEDspot VLE D 5.5-80W  
GU10 927 36D UK

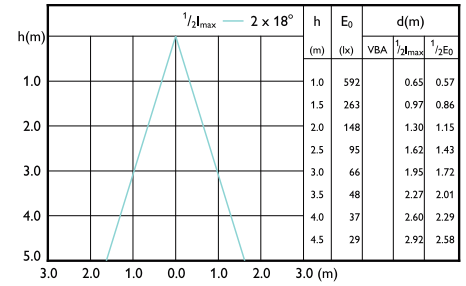

Beam diagram - MAS LED spot VLEDT3.7-50W  
GU10 927 36DUK

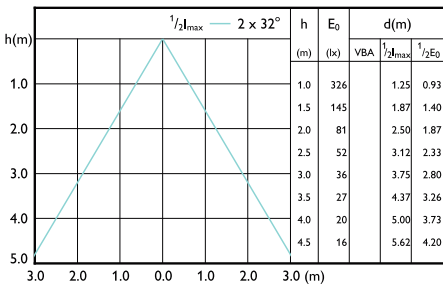

Beam diagram - MAS LED spot VLE D 3.7-50W  
GU10 930 60D

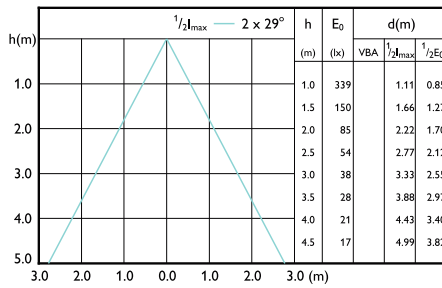

Beam diagram - MAS LED spot VLE D 3.7-50W  
GU10 940 60D

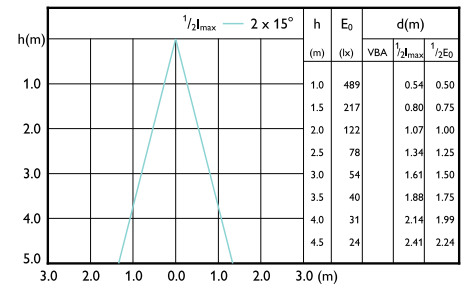

Beam diagram - MAS LED spot VLE D 2.8-35W  
GU10 927 36D

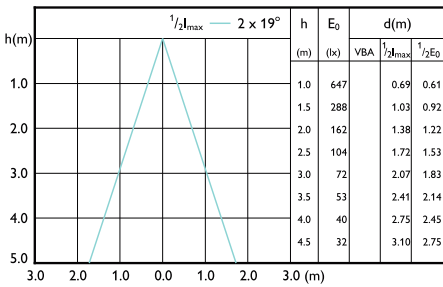

Beam diagram - MAS LEDspot VLE D 3.7-50W  
GU10 930 36D UK

## MASTER VALUE LED spot MV

