



# An optimum combination of value and performance, MASTER Value LEDspot MV is a perfect fit for spot lighting

## MASTER VALUE LED spot MV

Delivering a warm, halogen-like accent beam, MASTER VALUE is a perfect fit for spot lighting. Thanks to its high CRI, it realizes more natural colors, creating cozy and comfortable ambiances for residential and hospitality projects, and emphasizing the beauty of merchandise in retail. These LED spots MV GU10 have the familiar look and feel of spot lamps, keeping the classic beauty of glass spots and adding the strong performance of LED technology. The dimming function enables you to create the atmosphere you desire, and it works with broad selection of dimmers. MASTER VALUE also offers more energy savings than normal LED spots.

### Benefits

- With MASTER VALUE spotlight up to 80% energy saving compared with halogen lamps
- Best mimic of a halogen spot for atmosphere creation
- Perfect replacement for traditional GU10 lamps

## MASTER VALUE LED spot MV

### Features

- Dimmable range
- Compatible with an extensive range of dimmers
- Patented intelligent driver
- Lifetime of 25,000 hours
- No UV and Cool Beam (no IR), making it suitable for illuminating heat-sensitive objects (food, organic materials, paintings etc.)

### Application

- Hospitality
- Retail
- Residential

### Warnings and Safety

- Operating temperature range is between -20° C and 45° C ambient
- Only to apply in dry or damp locations and most of open fixtures with lamp-holders that offer sufficient space (10 mm free air space)
- Not intended for use with emergency light fixtures or exit lights

### Versions



LEDspots GM PAR16 GU10

# MASTER VALUE LED spot MV

## Dimensional drawing

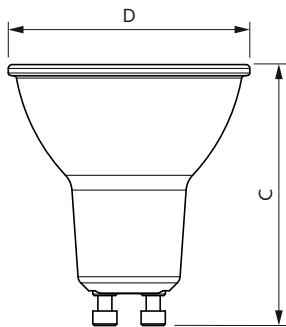
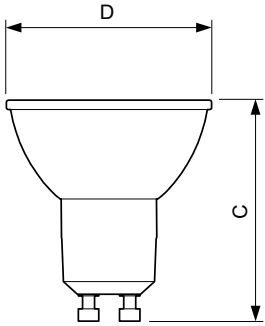

Product	D	C
MAS LED spot VLE D 3.7-35W GU10 930 36D	50 mm	54 mm
MAS LED spot VLE D 3.7-35W GU10 940 60D	50 mm	54 mm
MAS LED spot VLE D 4.9-50W GU10 927 60D	50 mm	54 mm
MAS LED spot VLE D 4.9-50W GU10 930 36D	50 mm	54 mm
MAS LED spot VLE D 4.9-50W GU10 930 60D	50 mm	54 mm
MAS LED spot VLE D 4.9-50W GU10 940 36D	50 mm	54 mm
MAS LED spot VLE D 4.9-50W GU10 940 60D	50 mm	54 mm
MAS LED spot VLE D 5-65W GU10 927 36D	50 mm	54 mm
MAS LED spot VLE D 5-65W GU10 940 36D	50 mm	54 mm
MAS LED spot VLE D 6.2-80W GU10 927 36D	50 mm	54 mm
MAS LED spot VLE D 6.2-80W GU10 930 36D	50 mm	54 mm
MAS LED spot VLE D 6.2-80W GU10 940 36D	50 mm	54 mm
MAS LED spot VLE D 6.2-80W GU10 965 36D	50 mm	54 mm
MAS LED spot VLE D 650lm GU10 930 120D	50 mm	54 mm
MAS LED spot VLE D 680lm GU10 940 120D	50 mm	54 mm
MAS LED spot VLE D 680lm GU10 965 120D	50 mm	54 mm
MAS LED spot VLE D 7-80W GU10 927 36D	50 mm	54 mm
MAS LED spot VLE D 7-80W GU10 940 36D	50 mm	54 mm
MAS LED spot VLE DT 4.9-50W GU10 927 36D	50 mm	54 mm
MAS LED spot VLE DT 6.2-80W GU10 927 36D	50 mm	56 mm
MAS LED spot VLEDT4.9-50W GU10 927 36DUK	50 mm	54 mm
Master LED 4.9-50W GU10 927 36D Dim	50 mm	54 mm
Master LED 4.9-50W GU10 930 36D Dim	50 mm	54 mm
Master LED 4.9-50W GU10 940 36D Dim	50 mm	54 mm

Product	D	C
MAS LED spot VLE D 2.8-35W GU10 927 36D	50 mm	54 mm
MAS LED spot VLE D 2.8-35W GU10 927 60D	50 mm	54 mm
MAS LED spot VLE D 2.8-35W GU10 930 36D	50 mm	54 mm
MAS LED spot VLE D 2.8-35W GU10 940 36D	50 mm	54 mm
MAS LED spot VLE D 3.7-35W GU10 927 36D	50 mm	54 mm
MAS LED spot VLE D 3.7-50W GU10 927 36D	50 mm	54 mm
MAS LED spot VLE D 3.7-50W GU10 927 60D	50 mm	54 mm
MAS LED spot VLE D 3.7-50W GU10 930 36D	50 mm	54 mm
MAS LED spot VLE D 3.7-50W GU10 930 60D	50 mm	54 mm
MAS LED spot VLE D 3.7-50W GU10 940 36D	50 mm	54 mm
MAS LED spot VLE D 3.7-50W GU10 940 60D	50 mm	54 mm
MAS LED spot VLE D 4.8-50W GU10 927 36D	50 mm	54 mm
MAS LED spot VLE D 5.5-80W GU10 927 36D	50 mm	54 mm
MAS LED spot VLE D 5.5-80W GU10 930 36D	50 mm	54 mm
MAS LED spot VLE D 5.5-80W GU10 940 36D	50 mm	54 mm
MAS LED spot VLE D 5.5-80W GU10 965 36D	50 mm	54 mm
MAS LED spot VLE D 650lm GU10 930 120D	50 mm	55.5 mm
MAS LED spot VLE D 680lm GU10 940 120D	50 mm	55.5 mm
MAS LED spot VLE D 680lm GU10 965 120D	50 mm	55.5 mm
MAS LED spot VLE DT 2.8-35W GU10 927 36D	50 mm	54 mm
MAS LED spot VLE DT 3.7-50W GU10 927 36D	50 mm	54 mm
MAS LED spot VLE DT 5.5-80W GU10 927 36D	50 mm	54 mm
MAS LED spot VLEDT3.7-50W GU10 927 36DUK	50 mm	54 mm

# MASTER VALUE LED spot MV

## Dimensional drawing

Product	D	C
MAS LEDspot VLE D 3.7-50W GU10 92736D5CT	50 mm	54 mm
MAS LEDspot VLE D 3.7-50W GU10 93036D5CT	50 mm	54 mm
MAS LEDspot VLE D 4.7-50W GU10 83036D5CT	50 mm	54 mm
MAS LEDspot VLE D 5-50W GU10 830 36D 1PF	50 mm	54 mm
MAS LEDspot VLE D 5-50W GU10 840 36D 1PF	50 mm	54 mm
MAS LEDspotVLE D 3.7-50W GU10 930 36D UK	50 mm	54 mm
MAS LEDspotVLE D 3.7-50W GU10 940 36D UK	50 mm	54 mm
MASLEDspot VLE D 5.5-80W GU10 927 36D UK	50 mm	54 mm
MASLEDspot VLE D 5.5-80W GU10 930 36D UK	50 mm	54 mm
MASLEDspot VLE D 5.5-80W GU10 940 36D UK	50 mm	54 mm

General Information	
Cap-Base	GU10
Nominal lifetime	25,000 hour(s)
Light Technical	
LLMF At End Of Nominal Lifetime (Nom)	70 %
Operating and Electrical	
Input Frequency	50 to 60 Hz
Starting Time (Nom)	0.5 s
Mechanical and Housing	
Bulb Shape	PAR16

## General Information

Order Code	Full Product Name	Switching Cycle
929002059502	MAS LED spot VLE D 6.2-80W GU10 927 36D	50,000
929002059522	MAS LED spot VLE D 7-80W GU10 927 36D	50,000
929002065902	MAS LED spot VLE DT 6.2-80W GU10 927 36D	50,000
929002066002	MAS LED spot VLE D 6.2-80W GU10 940 36D	50,000
929002066022	MAS LED spot VLE D 7-80W GU10 940 36D	50,000
929002068402	MAS LED spot VLE D 6.2-80W GU10 930 36D	50,000
929002209902	MAS LED spot VLE D 6.2-80W GU10 965 36D	50,000
929004255702	MAS LED spot VLE DT 5.5-80W GU10 927 36D	50,000
929004255802	MAS LED spot VLE D 5.5-80W GU10 927 36D	50,000
929004255899	MASLEDspot VLE D 5.5-80W GU10 927 36D UK	50,000
929004255902	MAS LED spot VLE D 5.5-80W GU10 930 36D	50,000
929004255999	MASLEDspot VLE D 5.5-80W GU10 930 36D UK	50,000
929004256002	MAS LED spot VLE D 5.5-80W GU10 940 36D	50,000
929004256099	MASLEDspot VLE D 5.5-80W GU10 940 36D UK	50,000
929004256102	MAS LED spot VLE D 5.5-80W GU10 965 36D	50,000
929001348302	MAS LED spot VLE D 3.7-35W GU10 930 36D	50,000
929001348702	MAS LED spot VLE D 3.7-35W GU10 940 60D	50,000
929001348808	Master LED 4.9-50W GU10 927 36D Dim	50,000
929001348822	MAS LED spot VLE D 5-65W GU10 927 36D	50,000

Order Code	Full Product Name	Switching Cycle
929001348902	MAS LED spot VLE D 4.9-50W GU10 930 36D	50,000
929001348908	Master LED 4.9-50W GU10 930 36D Dim	50,000
929001349002	MAS LED spot VLE D 4.9-50W GU10 940 36D	50,000
929001349008	Master LED 4.9-50W GU10 940 36D Dim	50,000
929001349022	MAS LED spot VLE D 5-65W GU10 940 36D	50,000
929001349102	MAS LED spot VLE D 4.9-50W GU10 927 60D	50,000
929001349202	MAS LED spot VLE D 4.9-50W GU10 930 60D	50,000
929001349302	MAS LED spot VLE D 4.9-50W GU10 940 60D	50,000
929001350302	MAS LED spot VLE DT 4.9-50W GU10 927 36D	50,000
929001350399	MAS LED spot VLEDT4.9-50W GU10 927 36DUK	50,000
929002348402	MAS LEDspot VLE D 5-50W GU10 830 36D 1PF	50,000
929002351102	MAS LEDspot VLE D 5-50W GU10 840 36D 1PF	50,000
929002979402	MAS LED spot VLE D 3.7-35W GU10 927 36D	50,000
929002980102	MAS LED spot VLE D 4.8-50W GU10 927 36D	50,000
929004247102	MAS LED spot VLE DT 2.8-35W GU10 927 36D	50,000
929004247202	MAS LED spot VLE DT 3.7-50W GU10 927 36D	50,000
929004247299	MAS LED spot VLEDT3.7-50W GU10 927 36DUK	50,000
929004247302	MAS LED spot VLE D 2.8-35W GU10 927 36D	50,000
929004247402	MAS LED spot VLE D 2.8-35W GU10 930 36D	50,000

## MASTER VALUE LED spot MV

Order Code	Full Product Name	Switching Cycle	Order Code	Full Product Name	Switching Cycle
929004247502	MAS LED spot VLE D 2.8-35W GU10 940 36D	50,000	929002995552	MAS LEDspot VLE D 4.7-50W GU10 83036D5CT	50,000
929004247602	MAS LED spot VLE D 2.8-35W GU10 927 60D	50,000	929004247952	MAS LEDspot VLE D 3.7-50W GU10 92736D5CT	50,000
929004247902	MAS LED spot VLE D 3.7-50W GU10 927 36D	50,000	929004248052	MAS LEDspot VLE D 3.7-50W GU10 93036D5CT	50,000
929004248002	MAS LED spot VLE D 3.7-50W GU10 930 36D	50,000	929002210002	MAS LED spot VLE D 650lm GU10 930 120D	50,000
929004248098	MAS LEDspotVLE D 3.7-50W GU10 930 36D UK	50,000	929002210102	MAS LED spot VLE D 680lm GU10 940 120D	50,000
929004248102	MAS LED spot VLE D 3.7-50W GU10 940 36D	50,000	929002210202	MAS LED spot VLE D 680lm GU10 965 120D	50,000
929004248199	MAS LEDspotVLE D 3.7-50W GU10 940 36D UK	50,000	929004256202	MAS LED spot VLE D 650lm GU10 930 120D	50,000
929004248202	MAS LED spot VLE D 3.7-50W GU10 927 60D	25,000	929004256302	MAS LED spot VLE D 680lm GU10 940 120D	50,000
929004248302	MAS LED spot VLE D 3.7-50W GU10 930 60D	25,000	929004256402	MAS LED spot VLE D 680lm GU10 965 120D	50,000
929004248402	MAS LED spot VLE D 3.7-50W GU10 940 60D	25,000			

### Light Technical

Order Code	Full Product Name	Beam Angle (Nom)	Correlated Color	Color rendering		Luminous Intensity	
			Temperature (Nom)	index (CRI)	Color Code	Luminous Flux	(Nom)
929002059502	MAS LED spot VLE D 6.2-80W GU10 927 36D	36 degree(s)	2700 K	90	927	575 lm	850 cd
929002059522	MAS LED spot VLE D 7-80W GU10 927 36D	36 degree(s)	2700 K	90	927	650 lm	850 cd
929002065902	MAS LED spot VLE DT 6.2-80W GU10 927 36D	36 degree(s)	2700 K	90	922-927	575 lm	950 cd
929002066002	MAS LED spot VLE D 6.2-80W GU10 940 36D	36 degree(s)	4000 K	90	940	575 lm	850 cd
929002066022	MAS LED spot VLE D 7-80W GU10 940 36D	36 degree(s)	4000 K	90	940	680 lm	850 cd
929002068402	MAS LED spot VLE D 6.2-80W GU10 930 36D	36 degree(s)	3000 K	90	930	575 lm	850 cd
929002209902	MAS LED spot VLE D 6.2-80W GU10 965 36D	36 degree(s)	6500 K	90	6500	575 lm	850 cd
929004255702	MAS LED spot VLE DT 5.5-80W GU10 927 36D	36 degree(s)	2200 K	90	922-927	575 lm	950 cd
929004255802	MAS LED spot VLE D 5.5-80W GU10 927 36D	36 degree(s)	2700 K	90	927	575 lm	950 cd
929004255899	MASLEDspot VLE D 5.5-80W GU10 927 36D UK	36 degree(s)	2700 K	90	927	575 lm	950 cd
929004255902	MAS LED spot VLE D 5.5-80W GU10 930 36D	36 degree(s)	3000 K	90	930	575 lm	1,000 cd
929004255999	MASLEDspot VLE D 5.5-80W GU10 930 36D UK	36 degree(s)	3000 K	90	930	575 lm	1,000 cd
929004256002	MAS LED spot VLE D 5.5-80W GU10 940 36D	36 degree(s)	4000 K	90	940	575 lm	1,000 cd
929004256099	MASLEDspot VLE D 5.5-80W GU10 940 36D UK	36 degree(s)	4000 K	90	940	575 lm	1,000 cd
929004256102	MAS LED spot VLE D 5.5-80W GU10 965 36D	36 degree(s)	6500 K	90	965	575 lm	1,000 cd
929001348302	MAS LED spot VLE D 3.7-35W GU10 930 36D	36 degree(s)	3000 K	90	930	270 lm	500 cd
929001348702	MAS LED spot VLE D 3.7-35W GU10 940 60D	60 degree(s)	4000 K	90	940	285 lm	350 cd
929001348808	Master LED 4.9-50W GU10 927 36D Dim	36 degree(s)	2700 K	90	927	395 lm	650 cd
929001348822	MAS LED spot VLE D 5-65W GU10 927 36D	36 degree(s)	2700 K	90	927	395 lm	650 cd
929001348902	MAS LED spot VLE D 4.9-50W GU10 930 36D	36 degree(s)	3000 K	90	930	365 lm	650 cd
929001348908	Master LED 4.9-50W GU10 930 36D Dim	36 degree(s)	3000 K	90	930	405 lm	650 cd
929001349002	MAS LED spot VLE D 4.9-50W GU10 940 36D	36 degree(s)	4000 K	90	940	380 lm	700 cd
929001349008	Master LED 4.9-50W GU10 940 36D Dim	36 degree(s)	4000 K	90	940	420 lm	700 cd
929001349022	MAS LED spot VLE D 5-65W GU10 940 36D	36 degree(s)	4000 K	90	940	420 lm	700 cd
929001349102	MAS LED spot VLE D 4.9-50W GU10 927 60D	60 degree(s)	2700 K	90	927	355 lm	400 cd
929001349202	MAS LED spot VLE D 4.9-50W GU10 930 60D	60 degree(s)	3000 K	90	930	365 lm	400 cd
929001349302	MAS LED spot VLE D 4.9-50W GU10 940 60D	60 degree(s)	4000 K	90	940	380 lm	400 cd
929001350302	MAS LED spot VLE DT 4.9-50W GU10 927 36D	36 degree(s)	2200 K	90	922-927	355 lm	650 cd
929001350399	MAS LED spot VLEDT4.9-50W GU10 927 36DUK	36 degree(s)	2200 K	90	922-927	355 lm	650 cd
929002348402	MAS LEDspot VLE D 5-50W GU10 830 36D 1PF	36 degree(s)	3000 K	80	830	400 lm	650 cd
929002351102	MAS LEDspot VLE D 5-50W GU10 840 36D 1PF	36 degree(s)	4000 K	80	840	450 lm	750 cd
929002979402	MAS LED spot VLE D 3.7-35W GU10 927 36D	36 degree(s)	2700 K	90	927	270 lm	500 cd
929002980102	MAS LED spot VLE D 4.8-50W GU10 927 36D	36 degree(s)	2700 K	90	927	355 lm	650 cd
929004247102	MAS LED spot VLE DT 2.8-35W GU10 927 36D	36 degree(s)	2200 K	90	922-927	280 lm	550 cd
929004247202	MAS LED spot VLE DT 3.7-50W GU10 927 36D	36 degree(s)	2200 K	90	922-927	355 lm	700 cd
929004247299	MAS LED spot VLEDT3.7-50W GU10 927 36DUK	36 degree(s)	2200 K	90	922-927	355 lm	700 cd
929004247302	MAS LED spot VLE D 2.8-35W GU10 927 36D	36 degree(s)	2700 K	90	927	270 lm	600 cd

## MASTER VALUE LED spot MV

Order Code	Full Product Name	Beam Angle (Nom)	Correlated Color		Color rendering		Luminous Intensity	
			Temperature (Nom)		index (CRI)	Color Code	Luminous Flux	(Nom)
929004247402	MAS LED spot VLE D 2.8-35W GU10 930 36D	36 degree(s)	3000 K		90	930	270 lm	600 cd
929004247502	MAS LED spot VLE D 2.8-35W GU10 940 36D	36 degree(s)	4000 K		90	940	285 lm	600 cd
929004247602	MAS LED spot VLE D 2.8-35W GU10 927 60D	60 degree(s)	2700 K		90	927	270 lm	300 cd
929004247902	MAS LED spot VLE D 3.7-50W GU10 927 36D	36 degree(s)	2700 K		90	927	355 lm	750 cd
929004248002	MAS LED spot VLE D 3.7-50W GU10 930 36D	36 degree(s)	3000 K		90	930	365 lm	750 cd
929004248098	MAS LEDspotVLE D 3.7-50W GU10 930 36D UK	36 degree(s)	3000 K		90	930	365 lm	750 cd
929004248102	MAS LED spot VLE D 3.7-50W GU10 940 36D	36 degree(s)	4000 K		90	940	380 lm	800 cd
929004248199	MAS LEDspotVLE D 3.7-50W GU10 940 36D UK	36 degree(s)	4000 K		90	940	380 lm	800 cd
929004248202	MAS LED spot VLE D 3.7-50W GU10 927 60D	60 degree(s)	2700 K		90	927	355 lm	400 cd
929004248302	MAS LED spot VLE D 3.7-50W GU10 930 60D	60 degree(s)	3000 K		90	930	365 lm	400 cd
929004248402	MAS LED spot VLE D 3.7-50W GU10 940 60D	60 degree(s)	4000 K		90	940	370 lm	420 cd
929002995552	MAS LEDspot VLE D 4.7-50W GU10 83036D5CT	36 degree(s)	3000 K		80	830	345 lm	650 cd
929004247952	MAS LEDspot VLE D 3.7-50W GU10 92736D5CT	36 degree(s)	2700 K		90	927	355 lm	750 cd
929004248052	MAS LEDspot VLE D 3.7-50W GU10 93036D5CT	36 degree(s)	3000 K		90	930	365 lm	750 cd
929002210002	MAS LED spot VLE D 650lm GU10 930 120D	120 degree(s)	3000 K		90	930	650 lm	200 cd
929002210102	MAS LED spot VLE D 680lm GU10 940 120D	120 degree(s)	4000 K		90	940	680 lm	200 cd
929002210202	MAS LED spot VLE D 680lm GU10 965 120D	120 degree(s)	6500 K		90	6500	680 lm	200 cd
929004256202	MAS LED spot VLE D 650lm GU10 930 120D	120 degree(s)	3000 K		90	930	650 lm	220 cd
929004256302	MAS LED spot VLE D 680lm GU10 940 120D	120 degree(s)	4000 K		90	940	680 lm	220 cd
929004256402	MAS LED spot VLE D 680lm GU10 965 120D	120 degree(s)	6500 K		90	965	680 lm	220 cd

### Operating and Electrical

Order Code	Full Product Name	Line Frequency	Power Consumption	Wattage Equivalent	Order Code	Full Product Name	Line Frequency	Power Consumption	Wattage Equivalent
929002059502	MAS LED spot VLE D 6.2-80W GU10 927 36D	50 to 60 Hz	6.2 W	80 W	929004256002	MAS LED spot VLE D 5.5-80W GU10 940 36D	-	5.5 W	80 W
929002059522	MAS LED spot VLE D 7-80W GU10 927 36D	50 to 60 Hz	7 W	80 W	929004256099	MASLEDspot VLE D 5.5-80W GU10 940 36D UK	-	5.5 W	80 W
929002065902	MAS LED spot VLE DT 6.2-80W GU10 927 36D	50 to 60 Hz	6.2 W	80 W	929004256102	MAS LED spot VLE D 5.5-80W GU10 965 36D	-	5.5 W	80 W
929002066002	MAS LED spot VLE D 6.2-80W GU10 940 36D	50 to 60 Hz	6.2 W	80 W	929001348302	MAS LED spot VLE D 3.7-35W GU10 930 36D	50 to 60 Hz	3.7 W	35 W
929002066022	MAS LED spot VLE D 7-80W GU10 940 36D	50 to 60 Hz	7 W	80 W	929001348702	MAS LED spot VLE D 3.7-35W GU10 940 60D	50 to 60 Hz	3.7 W	35 W
929002068402	MAS LED spot VLE D 6.2-80W GU10 930 36D	50 to 60 Hz	6.2 W	80 W	929001348808	Master LED 4.9-50W GU10 927 36D Dim	50 to 60 Hz	5 W	50 W
929002209902	MAS LED spot VLE D 6.2-80W GU10 965 36D	50 to 60 Hz	6.2 W	80 W	929001348822	MAS LED spot VLE D 5-65W GU10 927 36D	50 to 60 Hz	5 W	65 W
929004255702	MAS LED spot VLE DT 5.5-80W GU10 927 36D	-	5.5 W	80 W	929001348902	MAS LED spot VLE D 4.9-50W GU10 930 36D	50 to 60 Hz	4.9 W	50 W
929004255802	MAS LED spot VLE D 5.5-80W GU10 927 36D	-	5.5 W	80 W	929001348908	Master LED 4.9-50W GU10 930 36D Dim	50 to 60 Hz	5 W	50 W
929004255899	MASLEDspot VLE D 5.5-80W GU10 927 36D UK	-	5.5 W	80 W	929001349002	MAS LED spot VLE D 4.9-50W GU10 940 36D	50 to 60 Hz	4.9 W	50 W
929004255902	MAS LED spot VLE D 5.5-80W GU10 930 36D	-	5.5 W	80 W	929001349008	Master LED 4.9-50W GU10 940 36D Dim	50 to 60 Hz	5 W	50 W
929004255999	MASLEDspot VLE D 5.5-80W GU10 930 36D UK	-	5.5 W	80 W	929001349022	MAS LED spot VLE D 5-65W GU10 940 36D	50 to 60 Hz	5 W	65 W

## MASTER VALUE LED spot MV

Order Code	Full Product Name	Line Frequency	Power Consumption	Wattage Equivalent
929001349102	MAS LED spot VLE D 4.9-50W GU10 927 60D	50 to 60 Hz	4.9 W	50 W
929001349202	MAS LED spot VLE D 4.9-50W GU10 930 60D	50 to 60 Hz	4.9 W	50 W
929001349302	MAS LED spot VLE D 4.9-50W GU10 940 60D	50 to 60 Hz	4.9 W	50 W
929001350302	MAS LED spot VLE DT 4.9-50W GU10 927 36D	50 to 60 Hz	4.9 W	50 W
929001350399	MAS LED spot VLEDT4.9-50W GU10 927 36DUK	50 to 60 Hz	4.9 W	50 W
929002348402	MAS LEDspot VLE D 5-50W GU10 830 36D 1PF	50 to 60 Hz	5 W	50 W
929002351102	MAS LEDspot VLE D 5-50W GU10 840 36D 1PF	50 to 60 Hz	5 W	50 W
929002979402	MAS LED spot VLE D 3.7-35W GU10 927 36D	50 to 60 Hz	3.7 W	35 W
929002980102	MAS LED spot VLE D 4.8-50W GU10 927 36D	50 to 60 Hz	4.8 W	50 W
929004247102	MAS LED spot VLE DT 2.8-35W GU10 927 36D	-	2.8 W	35 W
929004247202	MAS LED spot VLE DT 3.7-50W GU10 927 36D	-	3.7 W	50 W
929004247299	MAS LED spot VLEDT3.7-50W GU10 927 36DUK	-	3.7 W	50 W
929004247302	MAS LED spot VLE D 2.8-35W GU10 927 36D	-	2.8 W	35 W
929004247402	MAS LED spot VLE D 2.8-35W GU10 930 36D	-	2.8 W	35 W
929004247502	MAS LED spot VLE D 2.8-35W GU10 940 36D	-	2.8 W	35 W
929004247602	MAS LED spot VLE D 2.8-35W GU10 927 60D	-	2.8 W	35 W
929004247902	MAS LED spot VLE D 3.7-50W GU10 927 36D	-	3.7 W	50 W

Order Code	Full Product Name	Line Frequency	Power Consumption	Wattage Equivalent
929004248002	MAS LED spot VLE D 3.7-50W GU10 930 36D	-	3.7 W	50 W
929004248098	MAS LEDspotVLE D 3.7-50W GU10 930 36D UK	-	3.7 W	50 W
929004248102	MAS LED spot VLE D 3.7-50W GU10 940 36D	-	3.7 W	50 W
929004248199	MAS LEDspotVLE D 3.7-50W GU10 940 36D UK	-	3.7 W	50 W
929004248202	MAS LED spot VLE D 3.7-50W GU10 927 60D	-	3.7 W	50 W
929004248302	MAS LED spot VLE D 3.7-50W GU10 930 60D	-	3.7 W	50 W
929004248402	MAS LED spot VLE D 3.7-50W GU10 940 60D	-	3.7 W	50 W
929002995552	MAS LEDspot VLE D 4.7-50W GU10 83036D5CT	50 to 60 Hz	4.7 W	50 W
929004247952	MAS LEDspot VLE D 3.7-50W GU10 92736D5CT	-	3.7 W	50 W
929004248052	MAS LEDspot VLE D 3.7-50W GU10 93036D5CT	-	3.7 W	50 W
929002210002	MAS LED spot VLE D 650lm GU10 930 120D	50 to 60 Hz	6.2 W	-
929002210102	MAS LED spot VLE D 680lm GU10 940 120D	50 to 60 Hz	6.2 W	-
929002210202	MAS LED spot VLE D 680lm GU10 965 120D	50 to 60 Hz	6.2 W	-
929004256202	MAS LED spot VLE D 650lm GU10 930 120D	-	5.5 W	-
929004256302	MAS LED spot VLE D 680lm GU10 940 120D	-	5.5 W	-
929004256402	MAS LED spot VLE D 680lm GU10 965 120D	-	5.5 W	-

### Temperature

Order Code	Full Product Name	T-Case Maximum (Nom)
929002059502	MAS LED spot VLE D 6.2-80W GU10 927 36D	80 °C
929002059522	MAS LED spot VLE D 7-80W GU10 927 36D	80 °C
929002065902	MAS LED spot VLE DT 6.2-80W GU10 927 36D	75 °C
929002066002	MAS LED spot VLE D 6.2-80W GU10 940 36D	80 °C
929002066022	MAS LED spot VLE D 7-80W GU10 940 36D	80 °C
929002068402	MAS LED spot VLE D 6.2-80W GU10 930 36D	80 °C
929002209902	MAS LED spot VLE D 6.2-80W GU10 965 36D	80 °C
929004255702	MAS LED spot VLE DT 5.5-80W GU10 927 36D	66 °C

Order Code	Full Product Name	T-Case Maximum (Nom)
929004255802	MAS LED spot VLE D 5.5-80W GU10 927 36D	66 °C
929004255899	MASLEDspot VLE D 5.5-80W GU10 927 36D UK	66 °C
929004255902	MAS LED spot VLE D 5.5-80W GU10 930 36D	66 °C
929004255999	MASLEDspot VLE D 5.5-80W GU10 930 36D UK	66 °C
929004256002	MAS LED spot VLE D 5.5-80W GU10 940 36D	66 °C
929004256099	MASLEDspot VLE D 5.5-80W GU10 940 36D UK	66 °C
929004256102	MAS LED spot VLE D 5.5-80W GU10 965 36D	66 °C
929001348302	MAS LED spot VLE D 3.7-35W GU10 930 36D	80 °C

## MASTER VALUE LED spot MV

Order Code	Full Product Name	T-Case Maximum (Nom)
929001348702	MAS LED spot VLE D 3.7-35W GU10 940 60D	80 °C
929001348808	Master LED 4.9-50W GU10 927 36D Dim	80 °C
929001348822	MAS LED spot VLE D 5-65W GU10 927 36D	65 °C
929001348902	MAS LED spot VLE D 4.9-50W GU10 930 36D	80 °C
929001348908	Master LED 4.9-50W GU10 930 36D Dim	80 °C
929001349002	MAS LED spot VLE D 4.9-50W GU10 940 36D	80 °C
929001349008	Master LED 4.9-50W GU10 940 36D Dim	80 °C
929001349022	MAS LED spot VLE D 5-65W GU10 940 36D	65 °C
929001349102	MAS LED spot VLE D 4.9-50W GU10 927 60D	80 °C
929001349202	MAS LED spot VLE D 4.9-50W GU10 930 60D	80 °C
929001349302	MAS LED spot VLE D 4.9-50W GU10 940 60D	80 °C
929001350302	MAS LED spot VLE DT 4.9-50W GU10 927 36D	80 °C
929001350399	MAS LED spot VLEDT4.9-50W GU10 927 36DUK	65 °C
929002348402	MAS LEDspot VLE D 5-50W GU10 830 36D 1PF	85 °C
929002351102	MAS LEDspot VLE D 5-50W GU10 840 36D 1PF	85 °C
929002979402	MAS LED spot VLE D 3.7-35W GU10 927 36D	70 °C
929002980102	MAS LED spot VLE D 4.8-50W GU10 927 36D	80 °C
929004247102	MAS LED spot VLE DT 2.8-35W GU10 927 36D	52 °C
929004247202	MAS LED spot VLE DT 3.7-50W GU10 927 36D	60 °C
929004247299	MAS LED spot VLEDT3.7-50W GU10 927 36DUK	60 °C
929004247302	MAS LED spot VLE D 2.8-35W GU10 927 36D	50 °C

Order Code	Full Product Name	T-Case Maximum (Nom)
929004247402	MAS LED spot VLE D 2.8-35W GU10 930 36D	50 °C
929004247502	MAS LED spot VLE D 2.8-35W GU10 940 36D	50 °C
929004247602	MAS LED spot VLE D 2.8-35W GU10 927 60D	50 °C
929004247902	MAS LED spot VLE D 3.7-50W GU10 927 36D	66 °C
929004248002	MAS LED spot VLE D 3.7-50W GU10 930 36D	66 °C
929004248098	MAS LEDspotVLE D 3.7-50W GU10 930 36D UK	66 °C
929004248102	MAS LED spot VLE D 3.7-50W GU10 940 36D	66 °C
929004248199	MAS LEDspotVLE D 3.7-50W GU10 940 36D UK	66 °C
929004248202	MAS LED spot VLE D 3.7-50W GU10 927 60D	62 °C
929004248302	MAS LED spot VLE D 3.7-50W GU10 930 60D	62 °C
929004248402	MAS LED spot VLE D 3.7-50W GU10 940 60D	62 °C
929002995552	MAS LEDspot VLE D 4.7-50W GU10 83036D5CT	80 °C
929004247952	MAS LEDspot VLE D 3.7-50W GU10 92736D5CT	66 °C
929004248052	MAS LEDspot VLE D 3.7-50W GU10 93036D5CT	66 °C
929002210002	MAS LED spot VLE D 650lm GU10 930 120D	80 °C
929002210102	MAS LED spot VLE D 680lm GU10 940 120D	80 °C
929002210202	MAS LED spot VLE D 680lm GU10 965 120D	80 °C
929004256202	MAS LED spot VLE D 650lm GU10 930 120D	66 °C
929004256302	MAS LED spot VLE D 680lm GU10 940 120D	66 °C
929004256402	MAS LED spot VLE D 680lm GU10 965 120D	66 °C

### Controls and Dimming

Order Code	Full Product Name	Dimmable
929002059502	MAS LED spot VLE D 6.2-80W GU10 927 36D	Only with specific dimmers
929002059522	MAS LED spot VLE D 7-80W GU10 927 36D	Yes
929002065902	MAS LED spot VLE DT 6.2-80W GU10 927 36D	Only with specific dimmers
929002066002	MAS LED spot VLE D 6.2-80W GU10 940 36D	Only with specific dimmers
929002066022	MAS LED spot VLE D 7-80W GU10 940 36D	Yes
929002068402	MAS LED spot VLE D 6.2-80W GU10 930 36D	Only with specific dimmers
929002209902	MAS LED spot VLE D 6.2-80W GU10 965 36D	Only with specific dimmers
929004255702	MAS LED spot VLE DT 5.5-80W GU10 927 36D	Only with specific dimmers
929004255802	MAS LED spot VLE D 5.5-80W GU10 927 36D	Only with specific dimmers
929004255899	MASLEDspot VLE D 5.5-80W GU10 927 36D UK	Only with specific dimmers
929004255902	MAS LED spot VLE D 5.5-80W GU10 930 36D	Only with specific dimmers
929004255999	MASLEDspot VLE D 5.5-80W GU10 930 36D UK	Only with specific dimmers
929004256002	MAS LED spot VLE D 5.5-80W GU10 940 36D	Only with specific dimmers
929004256099	MASLEDspot VLE D 5.5-80W GU10 940 36D UK	Only with specific dimmers

Order Code	Full Product Name	Dimmable
929004256102	MAS LED spot VLE D 5.5-80W GU10 965 36D	Only with specific dimmers
929001348302	MAS LED spot VLE D 3.7-35W GU10 930 36D	Only with specific dimmers
929001348702	MAS LED spot VLE D 3.7-35W GU10 940 60D	Only with specific dimmers
929001348808	Master LED 4.9-50W GU10 927 36D Dim	Only with specific dimmers
929001348822	MAS LED spot VLE D 5-65W GU10 927 36D	Yes
929001348902	MAS LED spot VLE D 4.9-50W GU10 930 36D	Only with specific dimmers
929001348908	Master LED 4.9-50W GU10 930 36D Dim	Yes
929001349002	MAS LED spot VLE D 4.9-50W GU10 940 36D	Only with specific dimmers
929001349008	Master LED 4.9-50W GU10 940 36D Dim	Yes
929001349022	MAS LED spot VLE D 5-65W GU10 940 36D	Yes
929001349102	MAS LED spot VLE D 4.9-50W GU10 927 60D	Only with specific dimmers
929001349202	MAS LED spot VLE D 4.9-50W GU10 930 60D	Only with specific dimmers
929001349302	MAS LED spot VLE D 4.9-50W GU10 940 60D	Only with specific dimmers
929001350302	MAS LED spot VLE DT 4.9-50W GU10 927 36D	Only with specific dimmers
929001350399	MAS LED spot VLEDT4.9-50W GU10 927 36DUK	Only with specific dimmers

## MASTER VALUE LED spot MV

Order Code	Full Product Name	Dimmable
929002348402	MAS LEDspot VLE D 5-50W GU10 830 36D 1PF	Only with specific dimmers
929002351102	MAS LEDspot VLE D 5-50W GU10 840 36D 1PF	Only with specific dimmers
929002979402	MAS LED spot VLE D 3.7-35W GU10 927 36D	Only with specific dimmers
929002980102	MAS LED spot VLE D 4.8-50W GU10 927 36D	Only with specific dimmers
929004247102	MAS LED spot VLE DT 2.8-35W GU10 927 36D	Only with specific dimmers
929004247202	MAS LED spot VLE DT 3.7-50W GU10 927 36D	Only with specific dimmers
929004247299	MAS LED spot VLEDT3.7-50W GU10 927 36DUK	Only with specific dimmers
929004247302	MAS LED spot VLE D 2.8-35W GU10 927 36D	Only with specific dimmers
929004247402	MAS LED spot VLE D 2.8-35W GU10 930 36D	Only with specific dimmers
929004247502	MAS LED spot VLE D 2.8-35W GU10 940 36D	Only with specific dimmers
929004247602	MAS LED spot VLE D 2.8-35W GU10 927 60D	Only with specific dimmers
929004247902	MAS LED spot VLE D 3.7-50W GU10 927 36D	Only with specific dimmers
929004248002	MAS LED spot VLE D 3.7-50W GU10 930 36D	Only with specific dimmers
929004248098	MAS LEDspotVLE D 3.7-50W GU10 930 36D UK	Only with specific dimmers

Order Code	Full Product Name	Dimmable
929004248102	MAS LED spot VLE D 3.7-50W GU10 940 36D	Only with specific dimmers
929004248199	MAS LEDspotVLE D 3.7-50W GU10 940 36D UK	Only with specific dimmers
929004248202	MAS LED spot VLE D 3.7-50W GU10 927 60D	Only with specific dimmers
929004248302	MAS LED spot VLE D 3.7-50W GU10 930 60D	Only with specific dimmers
929004248402	MAS LED spot VLE D 3.7-50W GU10 940 60D	Only with specific dimmers
929002995552	MAS LEDspot VLE D 4.7-50W GU10 83036D5CT	Only with specific dimmers
929004247952	MAS LEDspot VLE D 3.7-50W GU10 92736D5CT	Only with specific dimmers
929004248052	MAS LEDspot VLE D 3.7-50W GU10 93036D5CT	Only with specific dimmers
929002210002	MAS LED spot VLE D 650lm GU10 930 120D	Only with specific dimmers
929002210102	MAS LED spot VLE D 680lm GU10 940 120D	Only with specific dimmers
929002210202	MAS LED spot VLE D 680lm GU10 965 120D	Only with specific dimmers
929004256202	MAS LED spot VLE D 650lm GU10 930 120D	Only with specific dimmers
929004256302	MAS LED spot VLE D 680lm GU10 940 120D	Only with specific dimmers
929004256402	MAS LED spot VLE D 680lm GU10 965 120D	Only with specific dimmers

### Mechanical and Housing

Order Code	Full Product Name	Bulb Finish
929002059502	MAS LED spot VLE D 6.2-80W GU10 927 36D	-
929002059522	MAS LED spot VLE D 7-80W GU10 927 36D	-
929002065902	MAS LED spot VLE DT 6.2-80W GU10 927 36D	-
929002066002	MAS LED spot VLE D 6.2-80W GU10 940 36D	-
929002066022	MAS LED spot VLE D 7-80W GU10 940 36D	-
929002068402	MAS LED spot VLE D 6.2-80W GU10 930 36D	-
929002209902	MAS LED spot VLE D 6.2-80W GU10 965 36D	-
929004255702	MAS LED spot VLE DT 5.5-80W GU10 927 36D	Clear
929004255802	MAS LED spot VLE D 5.5-80W GU10 927 36D	Clear
929004255899	MASLEDspot VLE D 5.5-80W GU10 927 36D UK	Clear
929004255902	MAS LED spot VLE D 5.5-80W GU10 930 36D	Clear
929004255999	MASLEDspot VLE D 5.5-80W GU10 930 36D UK	Clear
929004256002	MAS LED spot VLE D 5.5-80W GU10 940 36D	Clear
929004256099	MASLEDspot VLE D 5.5-80W GU10 940 36D UK	Clear
929004256102	MAS LED spot VLE D 5.5-80W GU10 965 36D	Clear
929001348302	MAS LED spot VLE D 3.7-35W GU10 930 36D	-
929001348702	MAS LED spot VLE D 3.7-35W GU10 940 60D	-
929001348808	Master LED 4.9-50W GU10 927 36D Dim	-
929001348822	MAS LED spot VLE D 5-65W GU10 927 36D	-
929001348902	MAS LED spot VLE D 4.9-50W GU10 930 36D	-

Order Code	Full Product Name	Bulb Finish
929001348908	Master LED 4.9-50W GU10 930 36D Dim	-
929001349002	MAS LED spot VLE D 4.9-50W GU10 940 36D	-
929001349008	Master LED 4.9-50W GU10 940 36D Dim	-
929001349022	MAS LED spot VLE D 5-65W GU10 940 36D	-
929001349102	MAS LED spot VLE D 4.9-50W GU10 927 60D	-
929001349202	MAS LED spot VLE D 4.9-50W GU10 930 60D	-
929001349302	MAS LED spot VLE D 4.9-50W GU10 940 60D	-
929001350302	MAS LED spot VLE DT 4.9-50W GU10 927 36D	-
929001350399	MAS LED spot VLEDT4.9-50W GU10 927 36DUK	-
929002348402	MAS LEDspot VLE D 5-50W GU10 830 36D 1PF	-
929002351102	MAS LEDspot VLE D 5-50W GU10 840 36D 1PF	-
929002979402	MAS LED spot VLE D 3.7-35W GU10 927 36D	-
929002980102	MAS LED spot VLE D 4.8-50W GU10 927 36D	-
929004247102	MAS LED spot VLE DT 2.8-35W GU10 927 36D	Clear
929004247202	MAS LED spot VLE DT 3.7-50W GU10 927 36D	Clear
929004247299	MAS LED spot VLEDT3.7-50W GU10 927 36DUK	Clear
929004247302	MAS LED spot VLE D 2.8-35W GU10 927 36D	Clear
929004247402	MAS LED spot VLE D 2.8-35W GU10 930 36D	Clear
929004247502	MAS LED spot VLE D 2.8-35W GU10 940 36D	Clear
929004247602	MAS LED spot VLE D 2.8-35W GU10 927 60D	Clear

## MASTER VALUE LED spot MV

Order Code	Full Product Name	Bulb Finish
929004247902	MAS LED spot VLE D 3.7-50W GU10 927 36D	Clear
929004248002	MAS LED spot VLE D 3.7-50W GU10 930 36D	Clear
929004248098	MAS LEDspotVLE D 3.7-50W GU10 930 36D UK	Clear
929004248102	MAS LED spot VLE D 3.7-50W GU10 940 36D	Clear
929004248199	MAS LEDspotVLE D 3.7-50W GU10 940 36D UK	Clear
929004248202	MAS LED spot VLE D 3.7-50W GU10 927 60D	Clear
929004248302	MAS LED spot VLE D 3.7-50W GU10 930 60D	Clear
929004248402	MAS LED spot VLE D 3.7-50W GU10 940 60D	Clear
929002995552	MAS LEDspot VLE D 4.7-50W GU10 83036D5CT	-

Order Code	Full Product Name	Bulb Finish
929004247952	MAS LEDspot VLE D 3.7-50W GU10 92736D5CT	Clear
929004248052	MAS LEDspot VLE D 3.7-50W GU10 93036D5CT	Clear
929002210002	MAS LED spot VLE D 650lm GU10 930 120D	-
929002210102	MAS LED spot VLE D 680lm GU10 940 120D	-
929002210202	MAS LED spot VLE D 680lm GU10 965 120D	-
929004256202	MAS LED spot VLE D 650lm GU10 930 120D	Frosted
929004256302	MAS LED spot VLE D 680lm GU10 940 120D	Frosted
929004256402	MAS LED spot VLE D 680lm GU10 965 120D	Frosted

### Approval and Application

Order Code	Full Product Name	Ambient temperature range	Energy Consumption kWh/1000 h
929002059502	MAS LED spot VLE D 6.2-80W GU10 927 36D	-20 to +45 °C	7 kWh
929002059522	MAS LED spot VLE D 7-80W GU10 927 36D	-20 °C to 45 °C	7 kWh
929002065902	MAS LED spot VLE DT 6.2-80W GU10 927 36D	-20 to +45 °C	7 kWh
929002066002	MAS LED spot VLE D 6.2-80W GU10 940 36D	-20 to +45 °C	7 kWh
929002066022	MAS LED spot VLE D 7-80W GU10 940 36D	-20 °C to 45 °C	7 kWh
929002068402	MAS LED spot VLE D 6.2-80W GU10 930 36D	-20 to +45 °C	7 kWh
929002209902	MAS LED spot VLE D 6.2-80W GU10 965 36D	-20 to +45 °C	7 kWh
929004255702	MAS LED spot VLE DT 5.5-80W GU10 927 36D	-20 to +45 °C	6 kWh
929004255802	MAS LED spot VLE D 5.5-80W GU10 927 36D	-20 to +45 °C	6 kWh
929004255899	MASLEDspot VLE D 5.5-80W GU10 927 36D UK	-20 to +45 °C	6 kWh
929004255902	MAS LED spot VLE D 5.5-80W GU10 930 36D	-20 to +45 °C	6 kWh
929004255999	MASLEDspot VLE D 5.5-80W GU10 930 36D UK	-20 to +45 °C	6 kWh
929004256002	MAS LED spot VLE D 5.5-80W GU10 940 36D	-20 to +45 °C	6 kWh
929004256099	MASLEDspot VLE D 5.5-80W GU10 940 36D UK	-20 to +45 °C	6 kWh
929004256102	MAS LED spot VLE D 5.5-80W GU10 965 36D	-20 to +45 °C	6 kWh
929001348302	MAS LED spot VLE D 3.7-35W GU10 930 36D	-	4 kWh
929001348702	MAS LED spot VLE D 3.7-35W GU10 940 60D	-	4 kWh
929001348808	Master LED 4.9-50W GU10 927 36D Dim	-20 °C to 45 °C	5 kWh

Order Code	Full Product Name	Ambient temperature range	Energy Consumption kWh/1000 h
929001348822	MAS LED spot VLE D 5-65W GU10 927 36D	-20 to +45 °C	5 kWh
929001348902	MAS LED spot VLE D 4.9-50W GU10 930 36D	-	5 kWh
929001348908	Master LED 4.9-50W GU10 930 36D Dim	-20 °C to 45 °C	5 kWh
929001349002	MAS LED spot VLE D 4.9-50W GU10 940 36D	-	5 kWh
929001349008	Master LED 4.9-50W GU10 940 36D Dim	-20 °C to 45 °C	5 kWh
929001349022	MAS LED spot VLE D 5-65W GU10 940 36D	-20 to +45 °C	5 kWh
929001349102	MAS LED spot VLE D 4.9-50W GU10 927 60D	-	5 kWh
929001349202	MAS LED spot VLE D 4.9-50W GU10 930 60D	-	5 kWh
929001349302	MAS LED spot VLE D 4.9-50W GU10 940 60D	-	5 kWh
929001350302	MAS LED spot VLE DT 4.9-50W GU10 927 36D	-	5 kWh
929001350399	MAS LED spot VLEDT4.9-50W GU10 927 36DUK	-	5 kWh
929002348402	MAS LEDspot VLE D 5-50W GU10 830 36D 1PF	-20 to +45 °C	-
929002351102	MAS LEDspot VLE D 5-50W GU10 840 36D 1PF	-20 to +45 °C	-
929002979402	MAS LED spot VLE D 3.7-35W GU10 927 36D	-20 to +45 °C	4 kWh
929002980102	MAS LED spot VLE D 4.8-50W GU10 927 36D	-20 to +45 °C	5 kWh
929004247102	MAS LED spot VLE DT 2.8-35W GU10 927 36D	-20 to +45 °C	3 kWh
929004247202	MAS LED spot VLE DT 3.7-50W GU10 927 36D	-20 to +45 °C	4 kWh
929004247299	MAS LED spot VLEDT3.7-50W GU10 927 36DUK	-20 to +45 °C	4 kWh

# MASTER VALUE LED spot MV

Order Code	Full Product Name	Ambient temperature range	Energy Consumption kWh/1000 h
929004247302	MAS LED spot VLE D 2.8-35W GU10 927 36D	-20 to +45 °C	3 kWh
929004247402	MAS LED spot VLE D 2.8-35W GU10 930 36D	-20 to +45 °C	3 kWh
929004247502	MAS LED spot VLE D 2.8-35W GU10 940 36D	-20 to +45 °C	3 kWh
929004247602	MAS LED spot VLE D 2.8-35W GU10 927 60D	-20 to +45 °C	3 kWh
929004247902	MAS LED spot VLE D 3.7-50W GU10 927 36D	-20 to +45 °C	4 kWh
929004248002	MAS LED spot VLE D 3.7-50W GU10 930 36D	-20 to +45 °C	4 kWh
929004248098	MAS LEDspotVLE D 3.7-50W GU10 930 36D UK	-20 to +45 °C	4 kWh
929004248102	MAS LED spot VLE D 3.7-50W GU10 940 36D	-20 to +45 °C	4 kWh
929004248199	MAS LEDspotVLE D 3.7-50W GU10 940 36D UK	-20 to +45 °C	4 kWh
929004248202	MAS LED spot VLE D 3.7-50W GU10 927 60D	-20 to +45 °C	4 kWh
929004248302	MAS LED spot VLE D 3.7-50W GU10 930 60D	-20 to +45 °C	4 kWh
929004248402	MAS LED spot VLE D 3.7-50W GU10 940 60D	-20 to +45 °C	4 kWh
929002995552	MAS LEDspot VLE D 4.7-50W GU10 83036D5CT	-20 to +45 °C	5 kWh
929004247952	MAS LEDspot VLE D 3.7-50W GU10 92736D5CT	-20 to +45 °C	4 kWh
929004248052	MAS LEDspot VLE D 3.7-50W GU10 93036D5CT	-20 to +45 °C	4 kWh
929002210002	MAS LED spot VLE D 650lm GU10 930 120D	-20 to +45 °C	7 kWh
929002210102	MAS LED spot VLE D 680lm GU10 940 120D	-20 to +45 °C	7 kWh
929002210202	MAS LED spot VLE D 680lm GU10 965 120D	-20 to +45 °C	7 kWh
929004256202	MAS LED spot VLE D 650lm GU10 930 120D	-20 to +45 °C	6 kWh
929004256302	MAS LED spot VLE D 680lm GU10 940 120D	-20 to +45 °C	6 kWh
929004256402	MAS LED spot VLE D 680lm GU10 965 120D	-20 to +45 °C	6 kWh

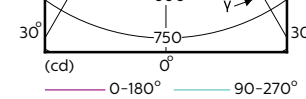
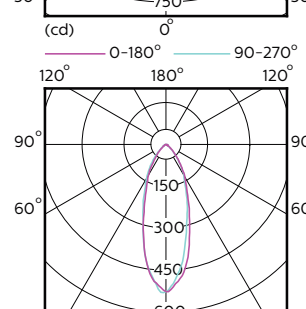
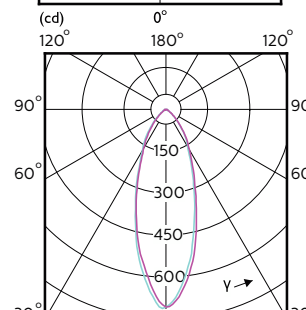
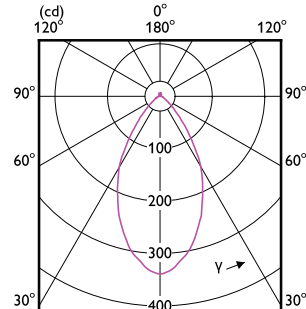
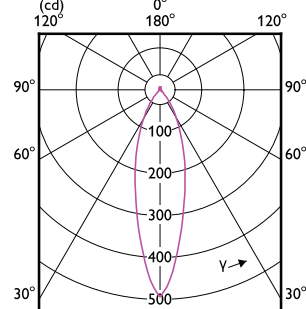
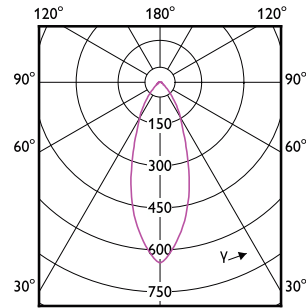

# MASTER VALUE LED spot MV

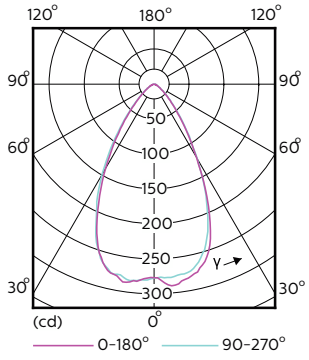

120°

90°

60°

# MASTER VALUE LED spot MV

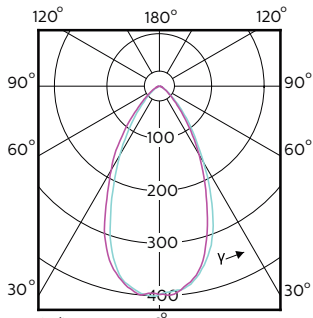

(cd) 0° 120° 180° 120°  
 0-180° 90-270°

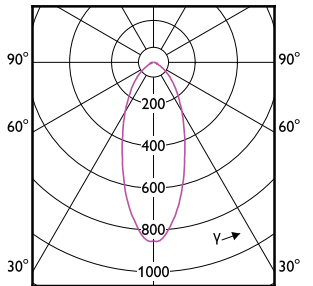

(cd) 0° 120° 180° 120°

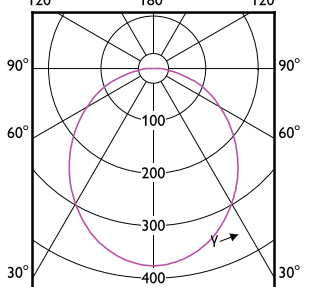

(cd/1000lm) 0° 120° 180° 120°

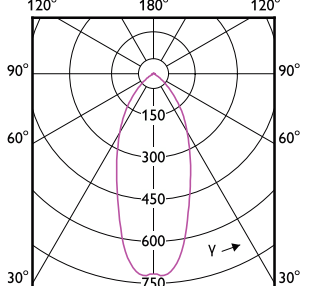

(cd) 0° 120° 180° 120°

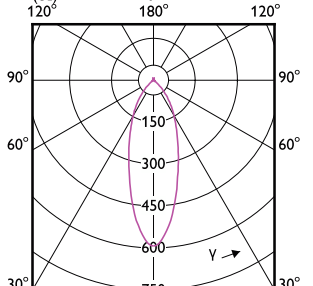

(cd) 0° 120° 180° 120°

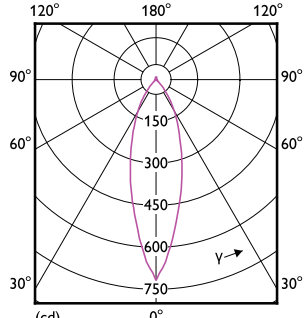

(cd) 0° 120° 180° 120°

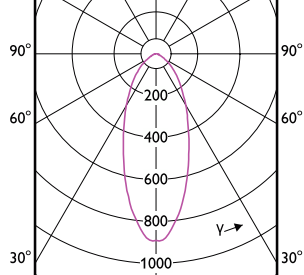

(cd) 0° 120° 180° 120°

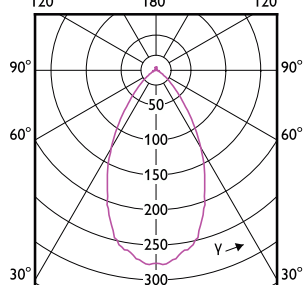

(cd) 0° 120° 180° 120°

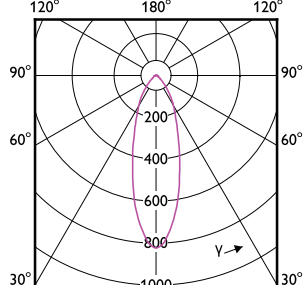

(cd) 0° 120° 180° 120°

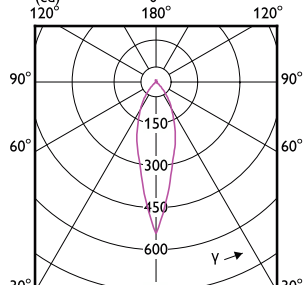

(cd) 0° 120° 180° 120°

# MASTER VALUE LED spot MV

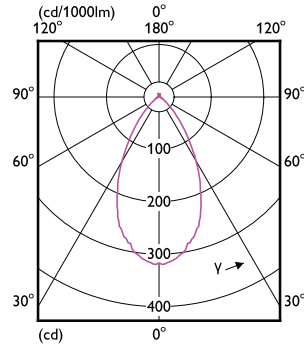
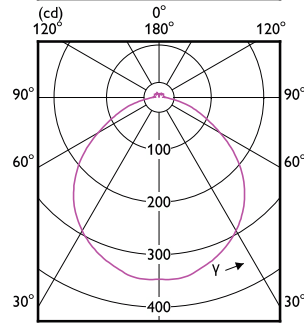
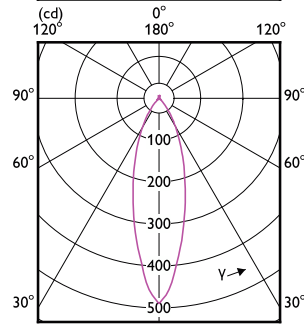
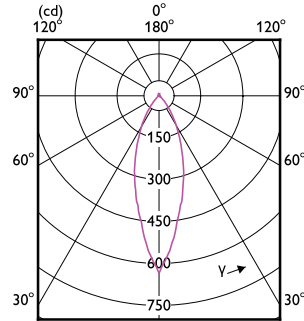
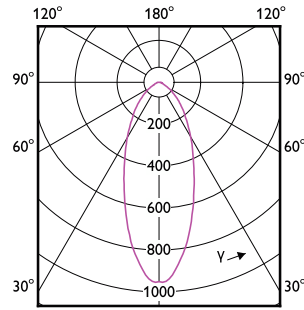
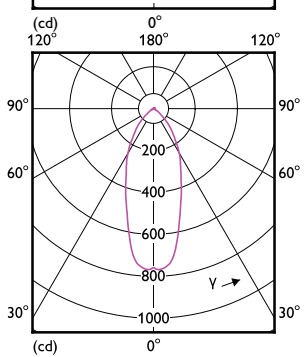
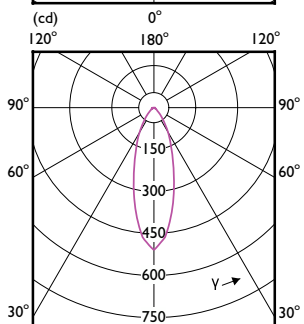
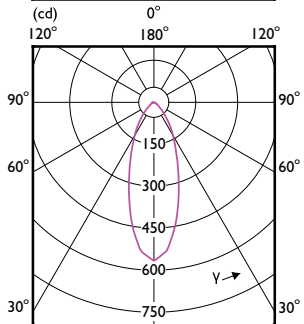
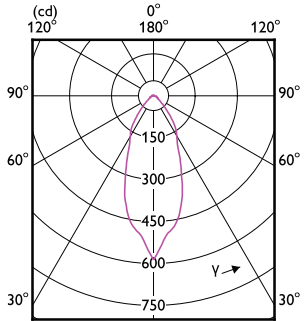
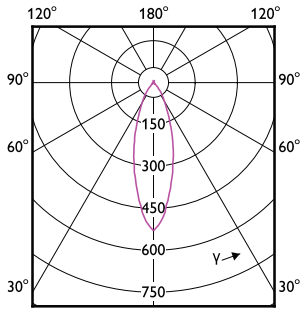

# MASTER VALUE LED spot MV

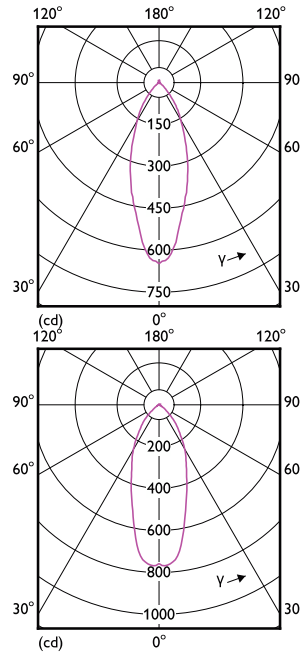
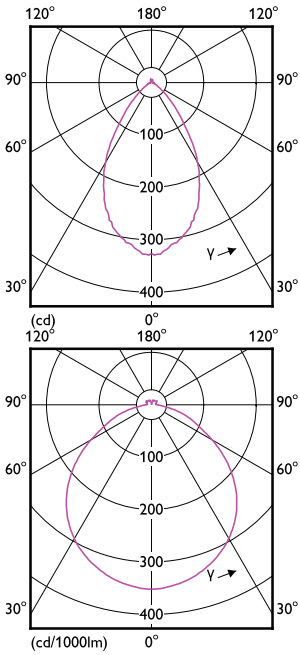

## Accent Diagrams

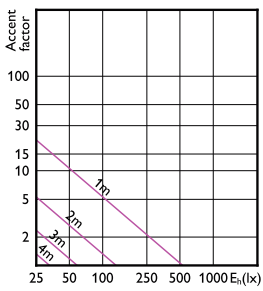

Accent Diagram - MAS LED spot VLE D 2.8-35W GU10 930 36D

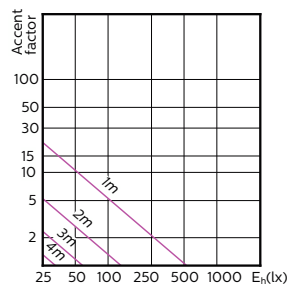

Accent Diagram - MAS LED spot VLEDT4.9-50W GU10 927 36DUK

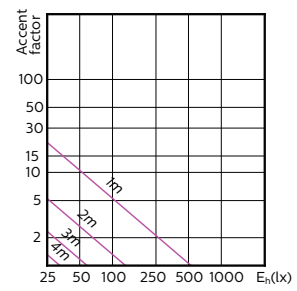

Accent Diagram - MAS LED spot VLE D 3.7-35W GU10 930 36D

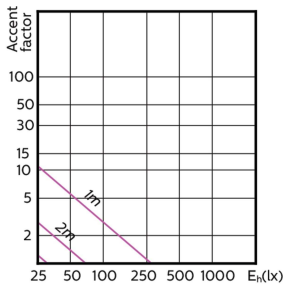

Accent Diagram - MAS LED spot VLE D 3.7-35W GU10 940 60D

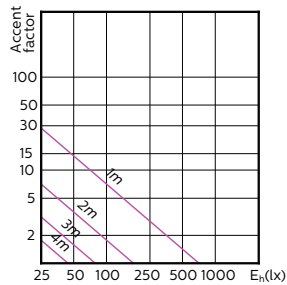

Accent Diagram - Master LED 4.9-50W GU10 927 36D Dim

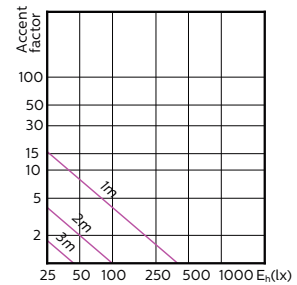

Accent Diagram - MAS LED spot VLE D 4.9-50W GU10 927 60D

# MASTER VALUE LED spot MV

## Accent Diagrams

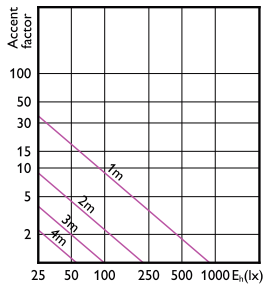

Accent Diagram - MAS LED spot VLE D 7-80W  
GU10 940 36D

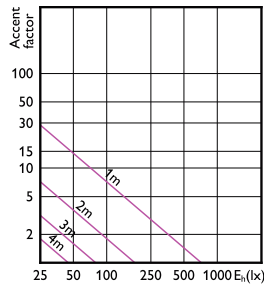

Accent Diagram - MASLEDspot VLE D 5.5-80W  
GU10 927 36D UK

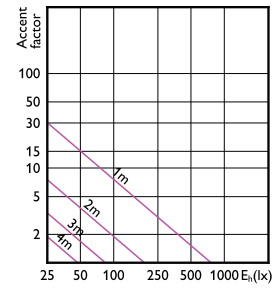

Accent Diagram - MAS LED spot VLE DT  
5.5-80W GU10 927 36D

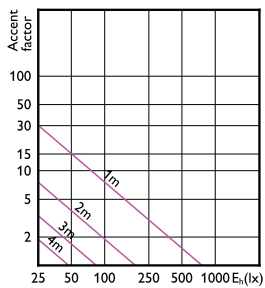

Accent Diagram - MAS LED spot VLE D 5.5-80W  
GU10 930 36D

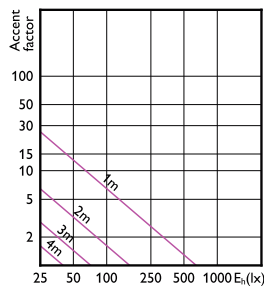

Accent Diagram - MAS LEDspot VLE D 5-50W  
GU10 830 36D 1PF

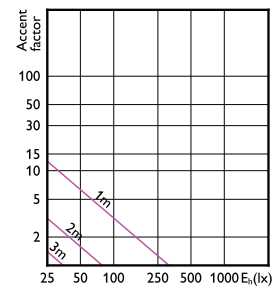

Accent Diagram - MAS LED spot VLE D 3.7-50W  
GU10 927 60D

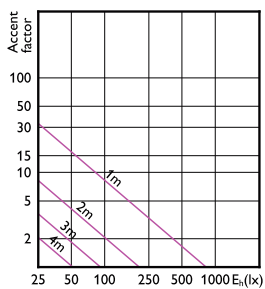

Accent Diagram - MAS LEDspot VLE D 5-50W  
GU10 840 36D 1PF

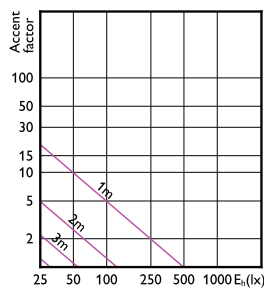

Accent Diagram - MAS LED spot VLE D 2.8-35W  
GU10 940 36D

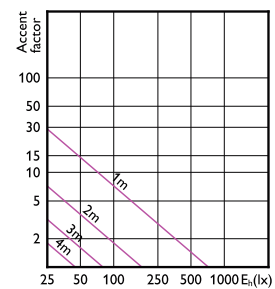

Accent Diagram - MAS LED spot VLE D 3.7-50W  
GU10 940 36D

# MASTER VALUE LED spot MV

## Accent Diagrams

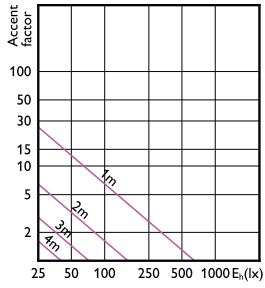

Accent Diagram - MAS LEDspotVLE D 3.7-50W  
GU10 930 36D UK

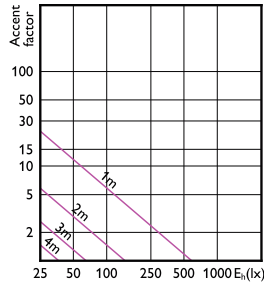

Accent Diagram - MAS LEDspot VLE D 4.7-50W  
GU10 83036D5CT

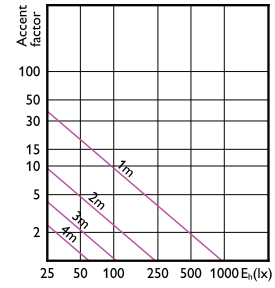

Accent Diagram - MAS LED spot VLE DT  
6.2-80W GU10 927 36D

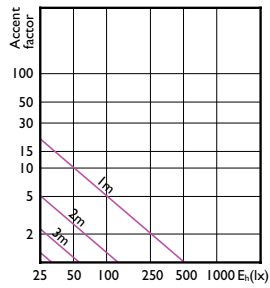

Accent Diagram - MAS LED spot VLE D 3.7-35W  
GU10 927 36D

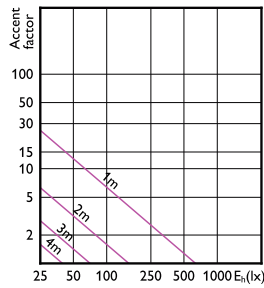

Accent Diagram - MAS LEDspot VLE D 3.7-50W  
GU10 92736D5CT

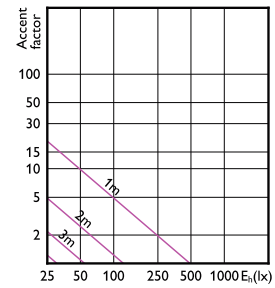

Accent Diagram - MAS LED spot VLE D 2.8-35W  
GU10 927 36D

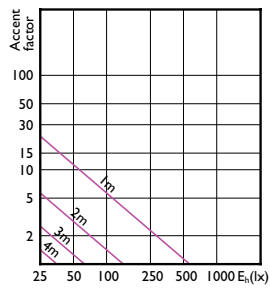

Accent Diagram - MAS LED spot VLE D 4.8-50W  
GU10 927 36D

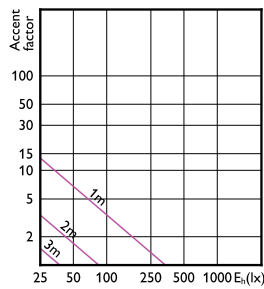

Accent Diagram - MAS LED spot VLE D 3.7-50W  
GU10 940 60D

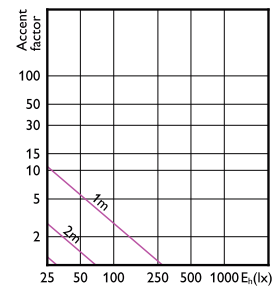

Accent Diagram - MAS LED spot VLE D 2.8-35W  
GU10 927 60D

# MASTER VALUE LED spot MV

## Accent Diagrams

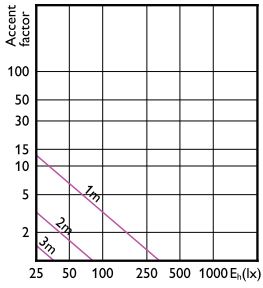

Accent Diagram - MAS LED spot VLE D 3.7-50W GU10 930 60D

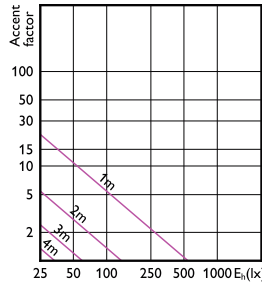

Accent Diagram - MAS LED spot VLE DT 2.8-35W GU10 927 36D

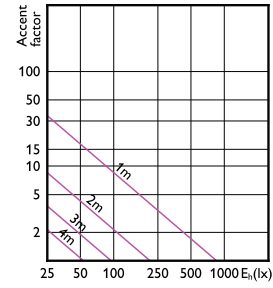

Accent Diagram - MAS LED spot VLE D 6.2-80W GU10 927 36D

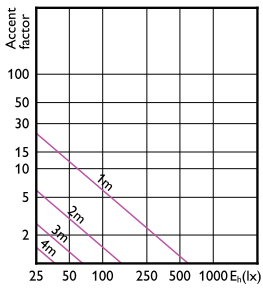

Accent Diagram - MAS LED spot VLE DT 3.7-50W GU10 927 36D

## Beam Diagrams

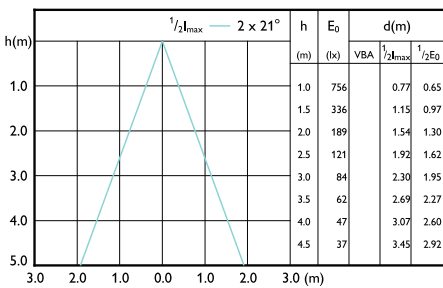

Beam diagram - MAS LED spot VLE DT 5.5-80W GU10 927 36D

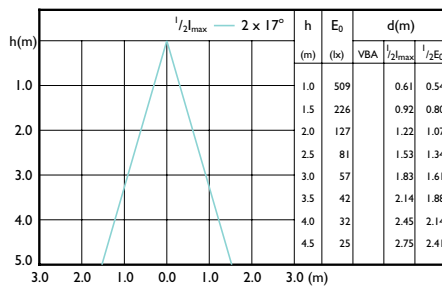

Beam diagram - MAS LED spot VLE D 3.7-35W GU10 927 36D

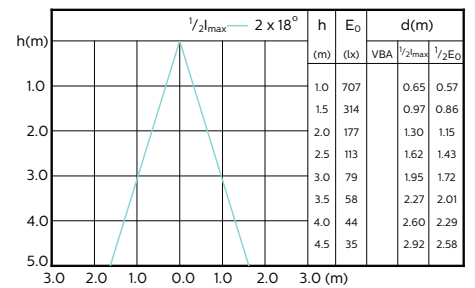

Beam diagram - MAS LED spot VLEDT 4.9-50W GU10 927 36DUK

# MASTER VALUE LED spot MV

## Beam Diagrams

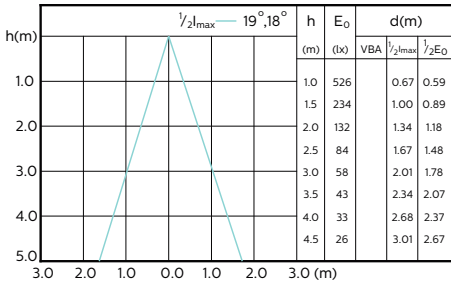

Beam diagram - MAS LED spot VLE D 3.7-35W GU10 930 36D

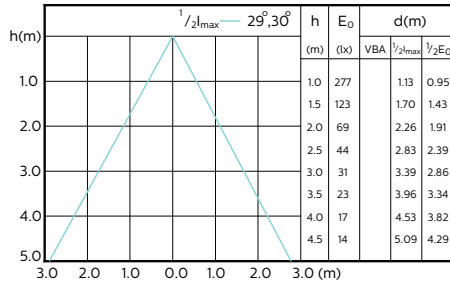

Beam diagram - MAS LED spot VLE D 3.7-35W GU10 940 60D

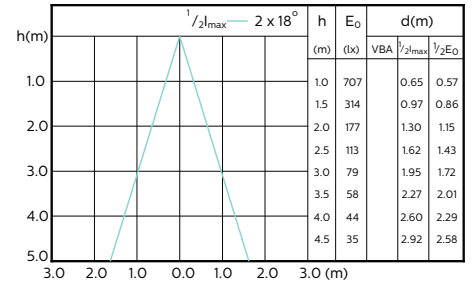

Beam diagram - Master LED 4.9-50W GU10 927 36D Dim

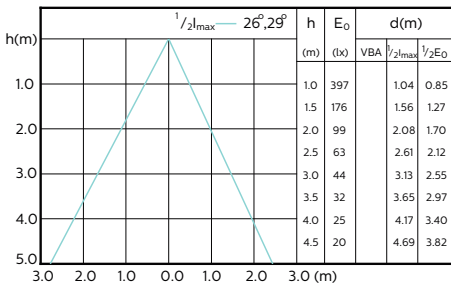

Beam diagram - MAS LED spot VLE D 4.9-50W GU10 927 60D

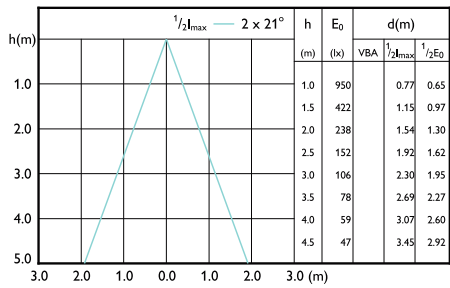

Beam diagram - MAS LED spot VLE DT 6.2-80W GU10 927 36D

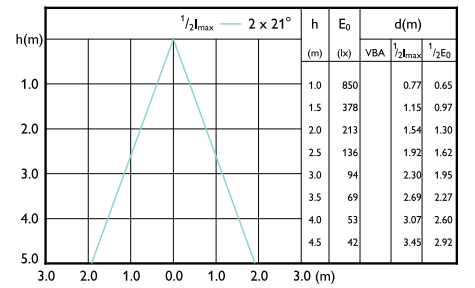

Beam diagram - MAS LED spot VLE D 6.2-80W GU10 927 36D

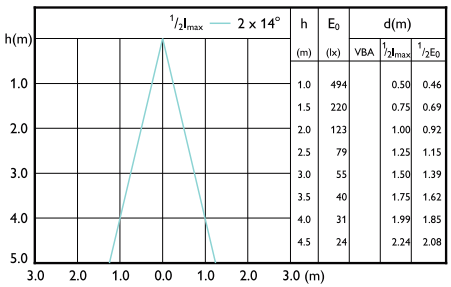

Beam diagram - MAS LED spot VLE D 2.8-35W GU10 940 36D

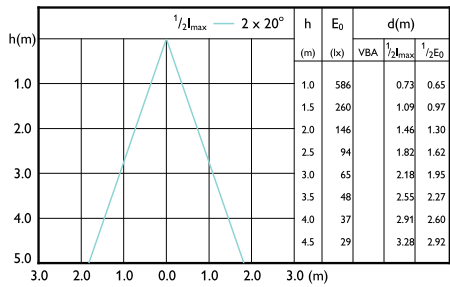

Beam diagram - MAS LEDspot VLE D 4.7-50W GU10 83036D5CT

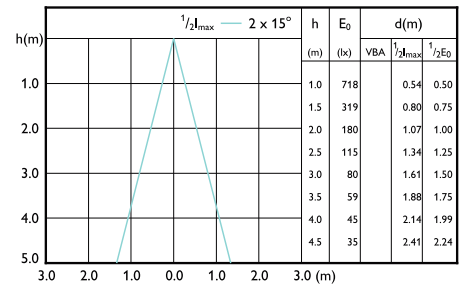

Beam diagram - MAS LED spot VLE D 3.7-50W GU10 940 36D

# MASTER VALUE LED spot MV

## Beam Diagrams

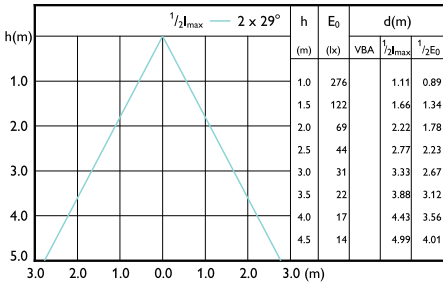

Beam diagram - MAS LED spot VLE D 2.8-35W GU10 927 60D

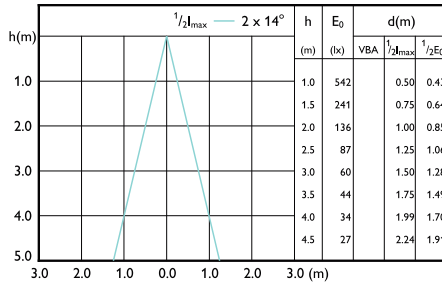

Beam diagram - MAS LED spot VLE DT 2.8-35W GU10 927 36D

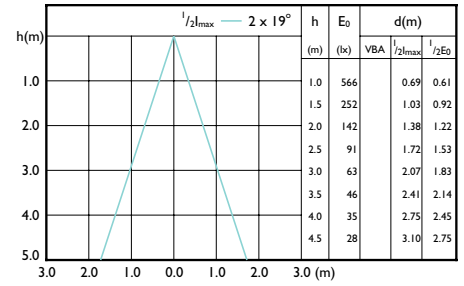

Beam diagram - MAS LED spot VLE D 4.8-50W GU10 927 36D

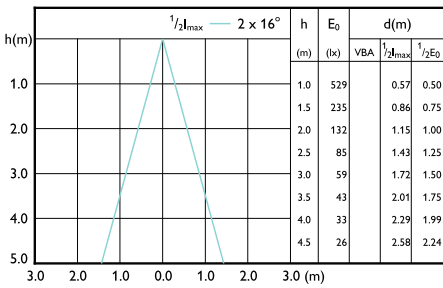

Beam diagram - MAS LED spot VLE D 2.8-35W GU10 930 36D

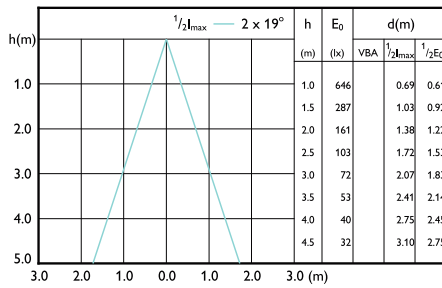

Beam diagram - MAS LEDspot VLE D 5-50W GU10 830 36D 1PF

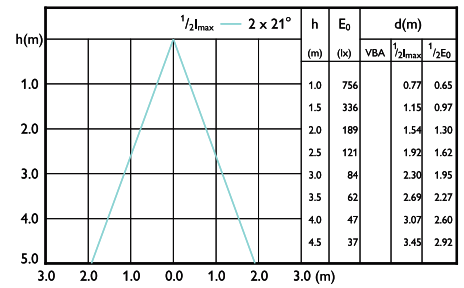

Beam diagram - MAS LED spot VLE D 5.5-80W GU10 930 36D

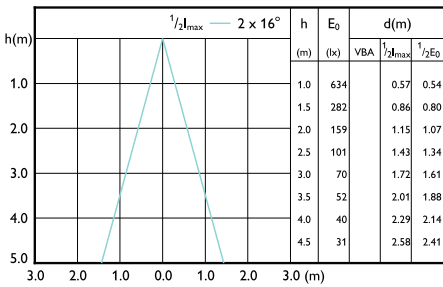

Beam diagram - MAS LEDspot VLE D 3.7-50W GU10 92736D5CT

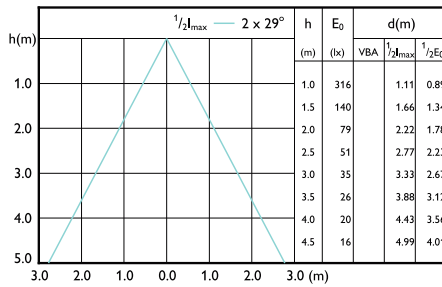

Beam diagram - MAS LED spot VLE D 3.7-50W GU10 927 60D

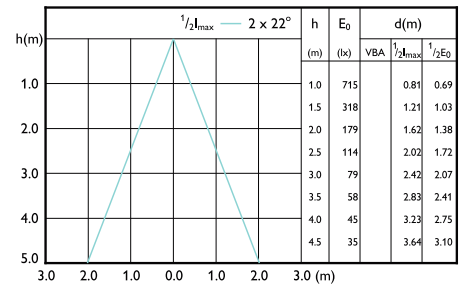

Beam diagram - MASLEDspot VLE D 5.5-80W GU10 927 36D UK

# MASTER VALUE LED spot MV

## Beam Diagrams

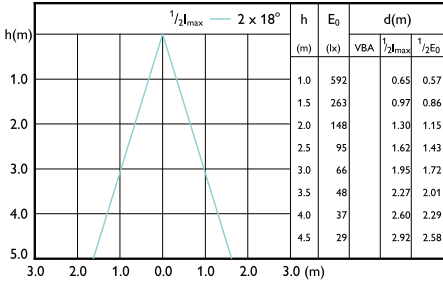

Beam diagram - MAS LED spot VLE DT 3.7-50W  
GU10 927 36D

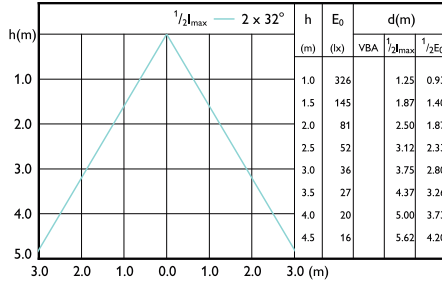

Beam diagram - MAS LED spot VLE D 3.7-50W  
GU10 930 60D

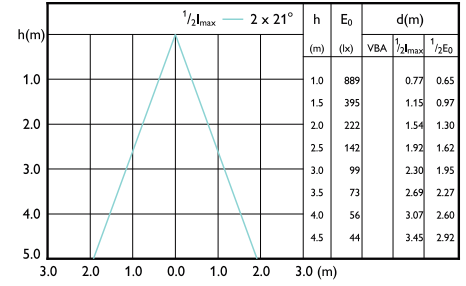

Beam diagram - MAS LED spot VLE D 7-80W  
GU10 940 36D

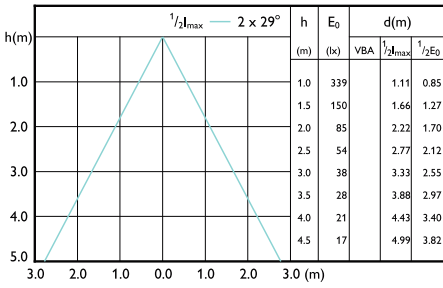

Beam diagram - MAS LED spot VLE D 3.7-50W  
GU10 940 60D

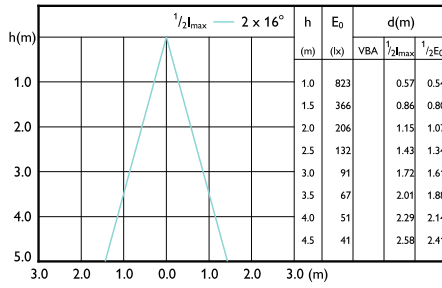

Beam diagram - MAS LEDspot VLE D 5-50W  
GU10 840 36D 1PF

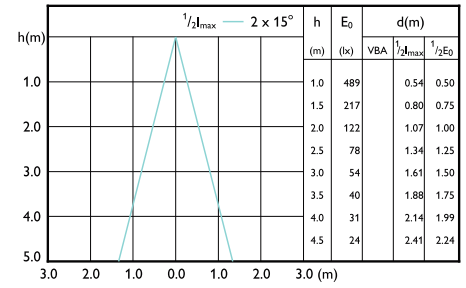

Beam diagram - MAS LED spot VLE D 2.8-35W  
GU10 927 36D

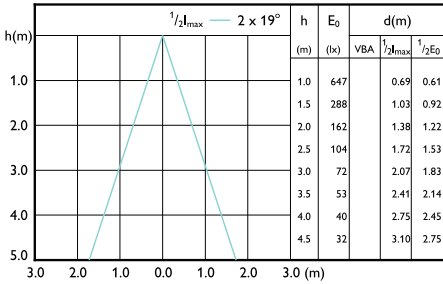

Beam diagram - MAS LEDspotVLE D 3.7-50W  
GU10 930 36D UK

# MASTER VALUE LED spot MV

