



# 產品說明

## MASTER VALUE LED 射燈 LV

MASTER LEDspot MR16 燈管，為您提供類鹵素/白熾燈的暖色重點照明光束，是理想的改裝解決方案，適用於餐旅服務業的投射照明與一般照明應用，特別適合燈光永久開啟的公共區域，例如接待區、大廳、走廊、樓梯間和廁所。結構堅固的 MASTER LEDspot MR16 提供 24° 的光束角度，光束散射分明。產品燈光非紫外光，也不含紅外線，非常適於照射易受高溫影響的物體（食物、有機材質、畫作等）。

### 优点

- 暖白色光
- 與一般的 20W 鹵素燈相較，最多可省下 80% 的能源

### 特点

- 改裝首選
- 使用壽命長上 22 倍，維護成本更低
- 24° 光束角度，光束散射分明
- 產品燈光非紫外光、無紅外線，產生的熱能減少，易受高溫影響的物體也不必擔心
- 不含水銀與有害物質

### 应用

- 旅館、餐廳、酒吧、咖啡店
- 大廳、走廊、樓梯間、廁所、接待區

### 安全提示

- 作業溫度範圍介於 -20° C 至 45° C 環境溫度之間
- 僅可使用於乾燥或潮濕的位置，且大部分有燈座的開放式燈具需提供足夠的空間（10 mm 的空氣流動空間）
- 不可用於緊急備用照明燈具或緊急出口照明

# MASTER VALUE LED 射燈 LV

## 二维绘图

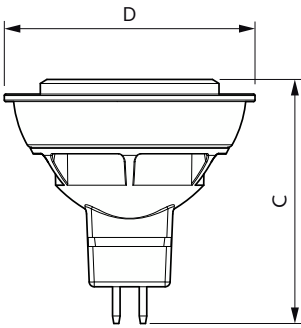
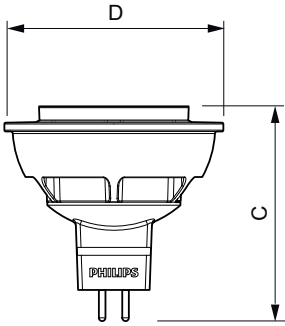

Product	D	C
MASTER LED 5.5-50W 2700K MR16 24D	50.2 mm	49 mm
MASTER LED 5.5-50W 3000K MR16 24D	50.2 mm	49 mm

Product	D	C
MASTER LED 4.9-50W 2700K MR16 24D	50.5 mm	50 mm
MASTER LED 4.9-50W 2700K MR16 36D	50.5 mm	50 mm
MASTER LED 4.9-50W 3000K MR16 24D	50.5 mm	50 mm
MASTER LED 4.9-50W 3000K MR16 36D	50.5 mm	50 mm
MASTER LED 4.9-50W 4000K MR16 24D	50.5 mm	50 mm
MASTER LED 4.9-50W 4000K MR16 36D	50.5 mm	50 mm

### 一般資訊

燈座基底	GU5.3
切換週期	50,000
標準使用壽命	25,000 h

### 照明技術

標稱壽命末期流明維持率

70 %

### 運轉與電力

輸入頻率	- Hz
起始時間 (標稱)	0.5 s
相等瓦數	50 W

### 控制與調光

可調光 否

### 機械與外罩

燈泡形狀 MR16

## 照明技術 (1/2)

Order Code	Full Product Name	光束角 (Nom)	相關色溫 (標稱) (CRI)	演色性指數	色碼
929001145908	MASTER LED 5.5-50W 2700K MR16 24D	24°	2700 K	80	827
929001146708	MASTER LED 5.5-50W 3000K MR16 24D	24°	3000 K	80	830
929003610608	MASTER LED 4.9-50W 2700K MR16 24D	24°	2700 K	90	927
929003610708	MASTER LED 4.9-50W 3000K MR16 24D	24°	3000 K	90	930
929003610808	MASTER LED 4.9-50W 4000K MR16 24D	24°	4000 K	90	940
929003610908	MASTER LED 4.9-50W 2700K MR16 36D	36°	2700 K	90	927
929003611008	MASTER LED 4.9-50W 3000K MR16 36D	36°	3000 K	90	930
929003611108	MASTER LED 4.9-50W 4000K MR16 36D	36°	4000 K	90	940

## 照明技術 (2/2)

Order Code	Full Product Name	光通量	光強 (標稱)	Order Code	Full Product Name	光通量	光強 (標稱)
929001145908	MASTER LED 5.5-50W 2700K MR16 24D	415 lm	1,800 cd	929003610808	MASTER LED 4.9-50W 4000K MR16 24D	430 lm	1,700 cd
929001146708	MASTER LED 5.5-50W 3000K MR16 24D	425 lm	1,800 cd	929003610908	MASTER LED 4.9-50W 2700K MR16 36D	415 lm	900 cd
929003610608	MASTER LED 4.9-50W 2700K MR16 24D	415 lm	1,600 cd	929003611008	MASTER LED 4.9-50W 3000K MR16 36D	425 lm	950 cd
929003610708	MASTER LED 4.9-50W 3000K MR16 24D	425 lm	1,700 cd	929003611108	MASTER LED 4.9-50W 4000K MR16 36D	430 lm	950 cd

# MASTER VALUE LED 射燈 LV

## 運轉與電力

Order Code	Full Product Name	電網頻率	耗電量
929001145908	MASTER LED 5.5-50W 2700K MR16 24D	- Hz	5.5 W
929001146708	MASTER LED 5.5-50W 3000K MR16 24D	- Hz	5.5 W
929003610608	MASTER LED 4.9-50W 2700K MR16 24D	-	4.9 W
929003610708	MASTER LED 4.9-50W 3000K MR16 24D	-	4.9 W

Order Code	Full Product Name	電網頻率	耗電量
929003610808	MASTER LED 4.9-50W 4000K MR16 24D	-	4.9 W
929003610908	MASTER LED 4.9-50W 2700K MR16 36D	-	4.9 W
929003611008	MASTER LED 4.9-50W 3000K MR16 36D	-	4.9 W
929003611108	MASTER LED 4.9-50W 4000K MR16 36D	-	4.9 W

## 溫度

Order Code	Full Product Name	T-case 上限 (標準)
929001145908	MASTER LED 5.5-50W 2700K MR16 24D	95 °C
929001146708	MASTER LED 5.5-50W 3000K MR16 24D	95 °C
929003610608	MASTER LED 4.9-50W 2700K MR16 24D	72 °C
929003610708	MASTER LED 4.9-50W 3000K MR16 24D	72 °C

Order Code	Full Product Name	T-case 上限 (標準)
929003610808	MASTER LED 4.9-50W 4000K MR16 24D	72 °C
929003610908	MASTER LED 4.9-50W 2700K MR16 36D	72 °C
929003611008	MASTER LED 4.9-50W 3000K MR16 36D	72 °C
929003611108	MASTER LED 4.9-50W 4000K MR16 36D	72 °C

## 機械與外罩

Order Code	Full Product Name	燈泡表層
929001145908	MASTER LED 5.5-50W 2700K MR16 24D	-
929001146708	MASTER LED 5.5-50W 3000K MR16 24D	-
929003610608	MASTER LED 4.9-50W 2700K MR16 24D	透明
929003610708	MASTER LED 4.9-50W 3000K MR16 24D	透明

Order Code	Full Product Name	燈泡表層
929003610808	MASTER LED 4.9-50W 4000K MR16 24D	透明
929003610908	MASTER LED 4.9-50W 2700K MR16 36D	透明
929003611008	MASTER LED 4.9-50W 3000K MR16 36D	透明
929003611108	MASTER LED 4.9-50W 4000K MR16 36D	透明

## 認證與應用

Order Code	Full Product Name	環境溫度範圍
929001145908	MASTER LED 5.5-50W 2700K MR16 24D	-20 至 +45 °C
929001146708	MASTER LED 5.5-50W 3000K MR16 24D	-20 至 +45 °C
929003610608	MASTER LED 4.9-50W 2700K MR16 24D	-20 至 +45 °C
929003610708	MASTER LED 4.9-50W 3000K MR16 24D	20 至 +45 °C
929003610808	MASTER LED 4.9-50W 4000K MR16 24D	-20 至 +45 °C
929003610908	MASTER LED 4.9-50W 2700K MR16 36D	-20 至 +45 °C
929003611008	MASTER LED 4.9-50W 3000K MR16 36D	-20 至 +45 °C
929003611108	MASTER LED 4.9-50W 4000K MR16 36D	-20 至 +45 °C

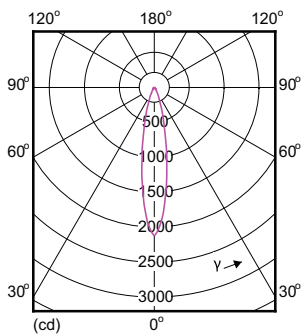
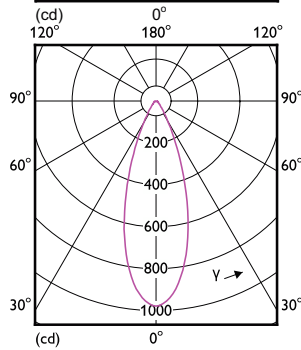
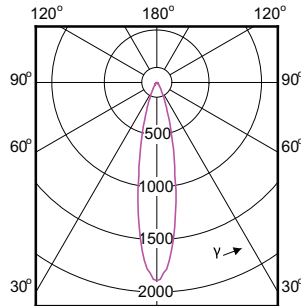

# MASTER VALUE LED 射燈 LV

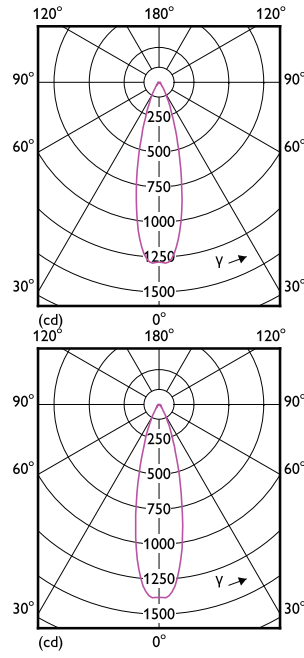
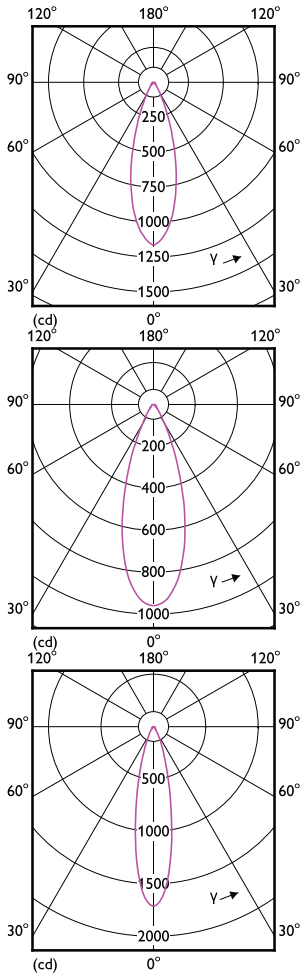

## Accent Diagrams

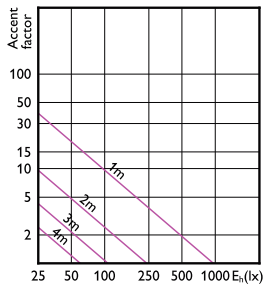

Accent Diagram - MASTER LED 4.9-50W 2700K MR16 36D

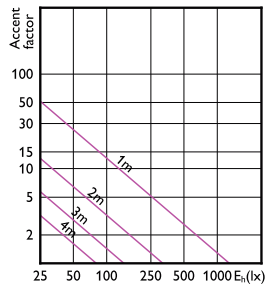

Accent Diagram - MASTER LED 4.9-50W 2700K MR16 24D

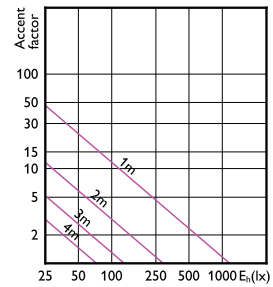

Accent Diagram - MASTER LED 4.9-50W 3000K MR16 36D

# MASTER VALUE LED 射燈 LV

## Accent Diagrams

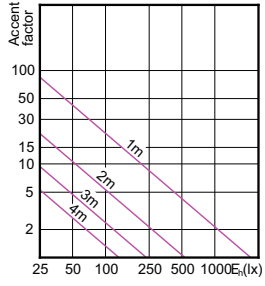

Accent Diagram - MASTER LED 5.5-50W 2700K MR16 24D

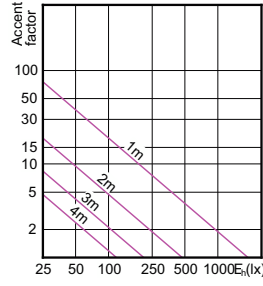

Accent Diagram - MASTER LED 5.5-50W 3000K MR16 24D

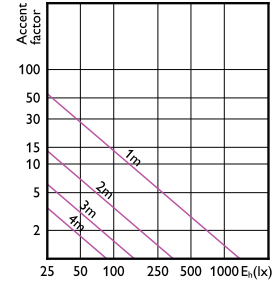

Accent Diagram - MASTER LED 4.9-50W 4000K MR16 24D

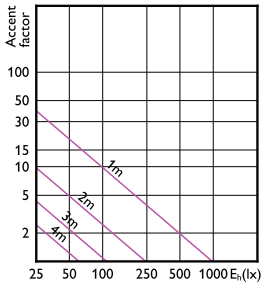

Accent Diagram - MASTER LED 4.9-50W 4000K MR16 36D

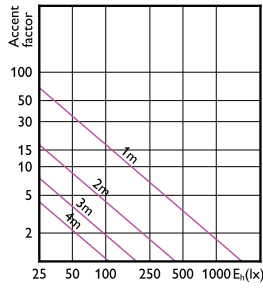

Accent Diagram - MASTER LED 4.9-50W 3000K MR16 24D

## Beam Diagrams

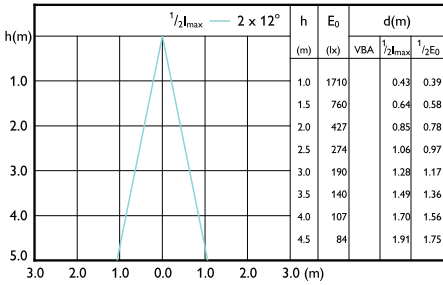

Beam diagram - MASTER LED 4.9-50W 3000K MR16 24D

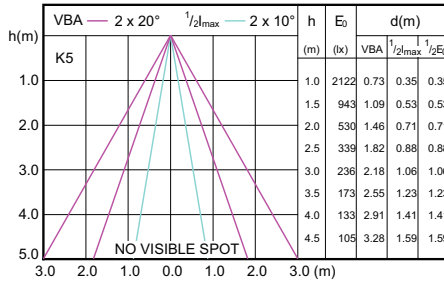

Beam diagram - MASTER LED 5.5-50W 2700K MR16 24D

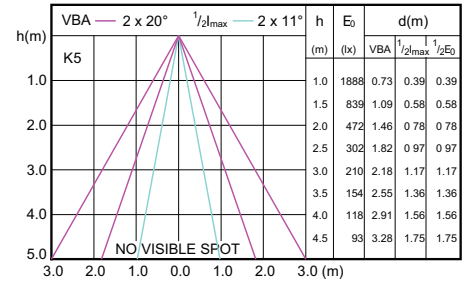

Beam diagram - MASTER LED 5.5-50W 3000K MR16 24D

## Beam Diagrams

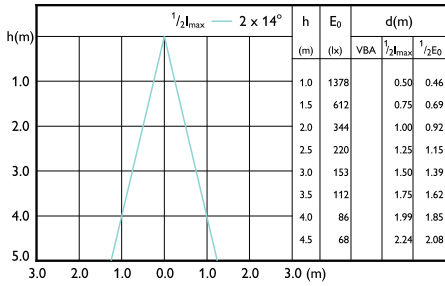

Beam diagram - MASTER LED 4.9-50W 4000K MR16 24D

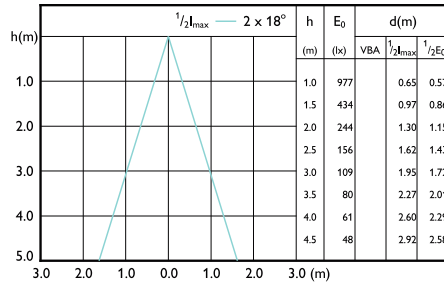

Beam diagram - MASTER LED 4.9-50W 4000K MR16 36D

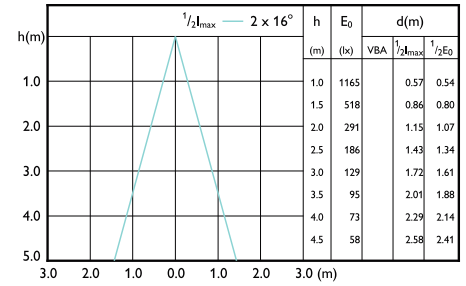

Beam diagram - MASTER LED 4.9-50W 3000K MR16 36D

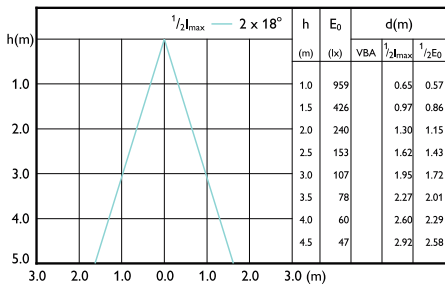

Beam diagram - MASTER LED 4.9-50W 2700K MR16 36D

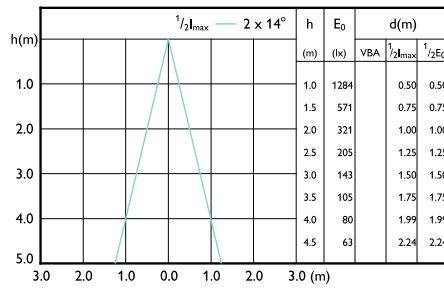

Beam diagram - MASTER LED 4.9-50W 2700K MR16 24D

