



The next generation in retail lighting -Simply irresistible

MASTERCOLOR CDM-Rm Elite Mini

The Elite family is at the very top of the MasterColor CDM range, and gives a unique combination of unbeatable light quality and consistent performance over lifetime, while keeping running costs low. The MasterColor DCM Elite MR16 combines the familiar compact shape of MR16 halogen lamps with the performance of ceramic metal halide MasterColor Elite lamps. Suited for accent/decorative lighting, general lighting and downlighting in retail applications; or for outdoor landscaping and architectural effects.

Benefits

- Easy to install and replace, 100% compatible with existing HID systems in markets today
- Miniaturized reflector eliminates need for optical design
- Excellent choice for today's lighting designs

Features

- Sparkling light - 90 CRI with crisp white light (3000K)
- Long life- 12,000 hours rated average life*
- Lamp-to-lamp color consistency
- GX10 twist-and-lock design locks base into place
- Miniaturized
- * Rated average life is the life obtained on the average, from large representative groups of lamps in laboratory tests under controlled conditions at 10 or more operating hours per start. It is based on survival of at least 50% of the lamps and allows for individual lamps or groups of lamps to vary considerably from the average.

MASTERCOLOR CDM-Rm Elite Mini

Application

- Ideal for display lighting, and accent lighting, general lighting and down lighting in retail applications; and for outdoor landscaping and architectural effects in retail and hospitality applications.

Warnings and Safety

- R "WARNING: These lamps can cause serious skin burn and eye inflammation from short wave ultraviolet radiation if outer envelope of the lamp is broken or punctured. Do not use where people will remain for more than a few minutes unless adequate shielding or other safety precautions are used. Certain lamps that will automatically extinguish when the outer envelope is broken or punctured are commercially available." This lamp complies with FDA radiation performance standard 21 CFR subchapter J. (USA:21 CFR 1040.30 Canada: SOR/DORS/80-381)

Versions



LPPR CDM-Rm 0008

Dimensional drawing

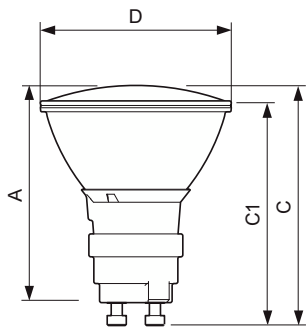

Product	D (max)	D	C (max)	C	C1 (max)	A (max)
CDM-Rm Elite Mini 20W/830 GX10 MR16 25D	51 mm	50 mm	65.4 mm	62.75 mm	60.9 mm	59 mm
CDM-Rm Elite Mini 35W/930 GX10 MR16 25D	51 mm	50 mm	65.4 mm	62.75 mm	60.9 mm	59 mm

MASTERCOLOR CDM-Rm Elite Mini

General Information

Cap-Base	GX10
Switching Cycle	1,350
Operating Position	UNIVERSAL

Light Technical

Beam Angle (Nom)	25 degree(s)
Chromaticity Coordinate X (Nom)	0.439
Chromaticity Coordinate Y (Nom)	0.403
Correlated Color Temperature (Nom)	3000 K

Operating and Electrical

Warm-up time to 60% light	120 s
---------------------------	-------

Controls and Dimming

Dimmable	No
----------	----

Mechanical and Housing

Bulb Shape	MR16
------------	------

Light Technical

Order Code	Full Product Name	Color rendering index (CRI)	LLMF At End Of Nominal Lifetime (Nom)	Luminous Efficacy (rated) (Nom)	Luminous Intensity (Nom)
928191105315	CDM-Rm Elite Mini 20W/830 GX10 MR16 25D	84	70 %	50 lm/W	4,000 cd
928194705315	CDM-Rm Elite Mini 35W/930 GX10 MR16 25D	90	80 %	60 lm/W	7,600 cd

Operating and Electrical

Order Code	Full Product Name	Voltage (Nom)	Power Consumption
928191105315	CDM-Rm Elite Mini 20W/830 GX10 MR16 25D	95 V	20.1 W

Order Code	Full Product Name	Voltage (Nom)	Power Consumption
928194705315	CDM-Rm Elite Mini 35W/930 GX10 MR16 25D	87 V	39.1 W

Approval and Application

Order Code	Full Product Name	Energy Consumption kWh/1000 h	Mercury (Hg) Content (Nom)
928191105315	CDM-Rm Elite Mini 20W/830 GX10 MR16 25D	22 kWh	3.5 mg
928194705315	CDM-Rm Elite Mini 35W/930 GX10 MR16 25D	43 kWh	4.7 mg

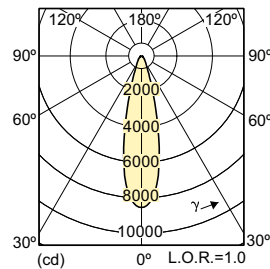
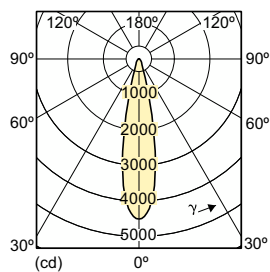

MASTERColor CDM-Rm Elite Mini

Accent Diagrams

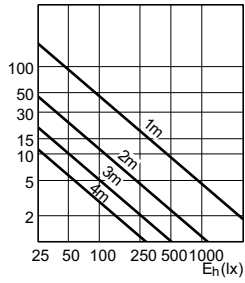

Accent Diagram - CDM-Rm Elite Mini 20W/830
GX10 MR16 25D

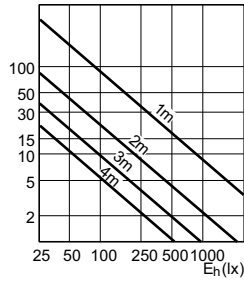

Accent Diagram - CDM-Rm Elite Mini 35W/930
GX10 MR16 25D

Beam Diagrams

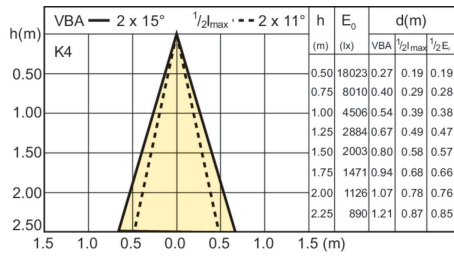

Beam diagram - CDM-Rm Elite Mini 20W/830
GX10 MR16 25D

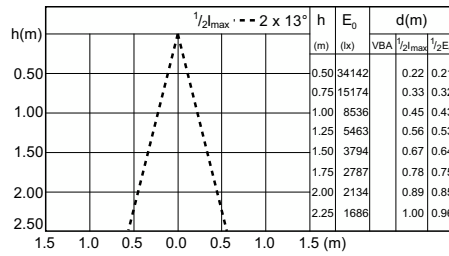

Beam diagram - CDM-Rm Elite Mini 35W/930
GX10 MR16 25D

