



LuxSpace square, recessed – high efficiency, visual comfort and a stylish design

LuxSpace square, recessed

Customers are looking to optimize all their resources, and that means not just their running costs (energy, etc.) but also their human resources. Energy savings are therefore a priority, but they must not have an adverse effect on the well-being of employees, who need a pleasant environment in order to be more productive, or on customers, who want to enjoy their shopping experience. LuxSpace provides the perfect combination of efficiency, light comfort and design, without compromising on lighting performance (color rendering and color uniformity). It offers a wide choice of options for creating the desired ambience, no matter the application.

Benefits

- Best-in-class efficacy
- Creates a gentle, natural light, ensuring visual comfort
- Perfect integration with the ceiling thanks to the thin, narrow rim; rimless version ideal for integration into plaster ceilings

LuxSpace square, recessed

Features

- Choice of four optics: high-gloss, faceted, matt and white
- Rim colors: high-gloss metalized, white (RAL9010), grey, black (RAL9004) as standard (any other RAL color possible upon request)
- Rimless version available
- Compliant for central emergency lighting with DC
- Multiple additional options: emergency lighting (single battery 3 hours), through-wiring

Application

- Offices
- Retail
- Hospitals
- Hotels
- Airports

Dimensional drawing

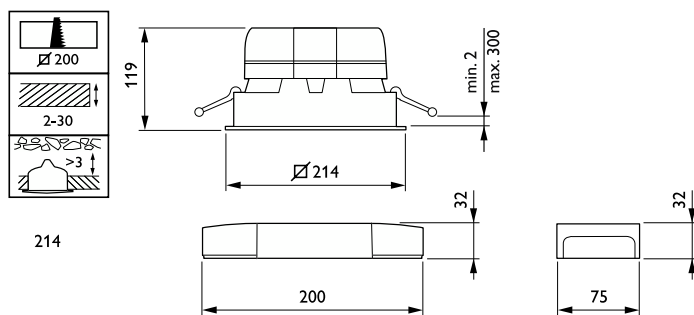

LuxSpace square, recessed

General Information	
Driver included	Yes
Light source replaceable	No
Number of gear units	1 unit
Service tag	Yes
Light Technical	
Color rendering index (CRI)	>80
Optic type	-
Operating and Electrical	
Protection class IEC	Safety class II
Input Voltage	220 to 240 V
Line Frequency	50 to 60 Hz
Suitable for random switching	Yes
Mechanical and Housing	
Housing Color	White
Mech. impact protection code	IK02
Ingress protection code	IP20
Approval and Application	
Ambient temperature range	+10 to +25 °C
CE mark	Yes
ENEC mark	ENEC mark
Flammability mark	For mounting on normally flammable surfaces
Glow-wire test	Temperature 650 °C, duration 30 s
Initial Performance (IEC Compliant)	
Luminous flux tolerance	+/-10%
Product Data	
Product family code	DN572B

Light Technical

Order Code	Full Product Name	Correlated Color	Luminous Efficacy	
		Temperature (Nom)	(rated) (Nom)	Luminous Flux
97073400	DN572B LED12S/840UE PSU-E C WH	4000 K	160 lm/W	1,250 lm
97074100	DN572B LED12S/830UE DIA-VLC-E C WH	3000 K	153 lm/W	1,200 lm
97075800	DN572B LED12S/840UE DIA-VLC-E C WH	4000 K	161 lm/W	1,250 lm
97076500	DN572B LED20S/830UE PSU-E C WH	3000 K	163 lm/W	2,100 lm
97077200	DN572B LED20S/840UE PSU-E C WH	4000 K	172 lm/W	2,200 lm
97078900	DN572B LED20S/830UE DIA-VLC-E C WH	3000 K	164 lm/W	2,100 lm
97079600	DN572B LED20S/840UE DIA-VLC-E C WH	4000 K	173 lm/W	2,200 lm
97080200	DN572B LED24S/830UE PSU-E C WH	3000 K	164 lm/W	2,400 lm
97081900	DN572B LED24S/840UE PSU-E C WH	4000 K	173 lm/W	2,500 lm
97082600	DN572B LED24S/830UE DIA-VLC-E C WH	3000 K	168 lm/W	2,400 lm
97083300	DN572B LED24S/840UE DIA-VLC-E C WH	4000 K	177 lm/W	2,500 lm

Operating and Electrical

Order Code	Full Product Name	Power Consumption
97073400	DN572B LED12S/840UE PSU-E C WH	7.9 W
97074100	DN572B LED12S/830UE DIA-VLC-E C WH	7.9 W
97075800	DN572B LED12S/840UE DIA-VLC-E C WH	7.9 W
97076500	DN572B LED20S/830UE PSU-E C WH	13 W
97077200	DN572B LED20S/840UE PSU-E C WH	13 W
97078900	DN572B LED20S/830UE DIA-VLC-E C WH	12.8 W

Order Code	Full Product Name	Power Consumption
97079600	DN572B LED20S/840UE DIA-VLC-E C WH	12.8 W
97080200	DN572B LED24S/830UE PSU-E C WH	10.8 W
97081900	DN572B LED24S/840UE PSU-E C WH	14.8 W
97082600	DN572B LED24S/830UE DIA-VLC-E C WH	14.4 W
97083300	DN572B LED24S/840UE DIA-VLC-E C WH	14.4 W

Controls and Dimming

LuxSpace square, recessed

Order Code	Full Product Name	Dimmable	Embedded control	Maximum dim level
97073400	DN572B LED12S/840UE PSU-E C WH	No	-	-
97074100	DN572B LED12S/830UE DIA-VLC-E C WH	Yes	Visible light communication	1%
97075800	DN572B LED12S/840UE DIA-VLC-E C WH	Yes	Visible light communication	1%
97076500	DN572B LED20S/830UE PSU-E C WH	No	-	-
97077200	DN572B LED20S/840UE PSU-E C WH	No	-	-
97078900	DN572B LED20S/830UE DIA-VLC-E C WH	Yes	Visible light communication	1%

Order Code	Full Product Name	Dimmable	Embedded control	Maximum dim level
97079600	DN572B LED20S/840UE DIA-VLC-E C WH	Yes	Visible light communication	1%
97080200	DN572B LED24S/830UE PSU-E C WH	No	-	-
97081900	DN572B LED24S/840UE PSU-E C WH	No	-	-
97082600	DN572B LED24S/830UE DIA-VLC-E C WH	Yes	Visible light communication	1%
97083300	DN572B LED24S/840UE DIA-VLC-E C WH	Yes	Visible light communication	1%

Initial Performance (IEC Compliant)

Order Code	Full Product Name	Initial chromaticity
97073400	DN572B LED12S/840UE PSU-E C WH	(0.38, 0.38) SDCM <2
97074100	DN572B LED12S/830UE DIA-VLC-E C WH	(0.43, 0.40) SDCM <2
97075800	DN572B LED12S/840UE DIA-VLC-E C WH	(0.38, 0.38) SDCM <2
97076500	DN572B LED20S/830UE PSU-E C WH	(0.43, 0.40) SDCM <2
97077200	DN572B LED20S/840UE PSU-E C WH	(0.38, 0.38) SDCM <2
97078900	DN572B LED20S/830UE DIA-VLC-E C WH	(0.43, 0.40) SDCM <2

Order Code	Full Product Name	Initial chromaticity
97079600	DN572B LED20S/840UE DIA-VLC-E C WH	(0.38, 0.38) SDCM <2
97080200	DN572B LED24S/830UE PSU-E C WH	(0.43, 0.40) SDCM <2
97081900	DN572B LED24S/840UE PSU-E C WH	(0.38, 0.38) SDCM <2
97082600	DN572B LED24S/830UE DIA-VLC-E C WH	(0.43, 0.40) SDCM <2
97083300	DN572B LED24S/840UE DIA-VLC-E C WH	(0.38, 0.38) SDCM <2

Polar Wide Diagrams

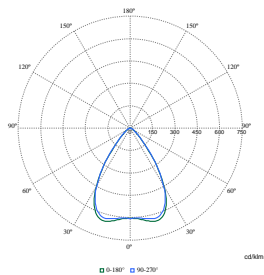

Polar Normal (separate) - DN572BI - 910505100945

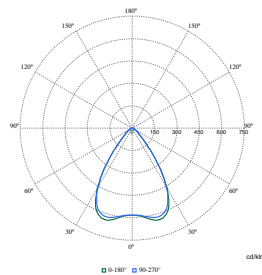

Polar Normal (separate) - DN572BI - 910505100951

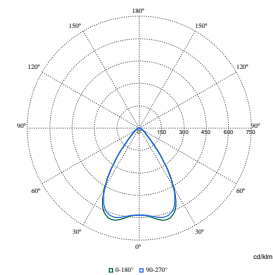

Polar Normal (separate) - DN572BI - 910505100950

LuxSpace square, recessed

Polar Wide Diagrams

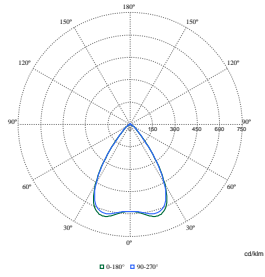

Polar Normal (separate) - DN572BI - 910505100953

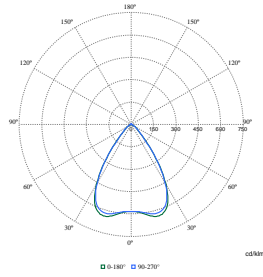

Polar Normal (separate) - DN572BI - 910505100949

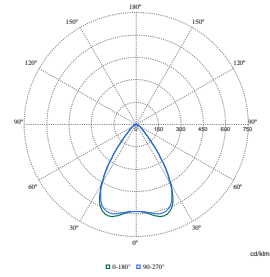

Polar Normal (separate) - DN572BI - 910505100948

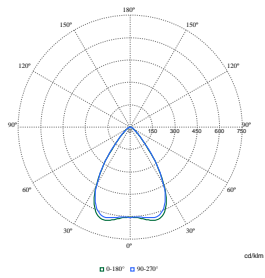

Polar Normal (separate) - DN572BI - 910505100944

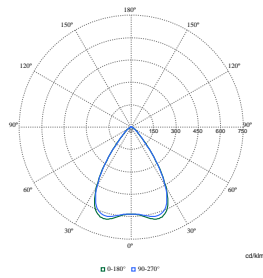

Polar Normal (separate) - DN572BI - 910505100954

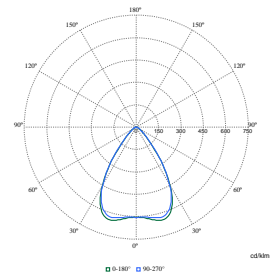

Polar Normal (separate) - DN572BI - 910505100946

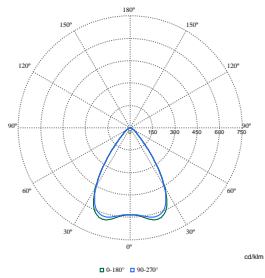

Polar Normal (separate) - DN572BI - 910505100952

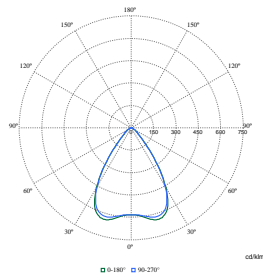

Polar Normal (separate) - DN572BI - 910505100947

LuxSpace square, recessed

