



Perfect sparkle, unrivalled efficiency

MASTERColour CDM-T Elite

Single-ended, very high-efficiency, long-life Ceramic Metal Halide discharge lamp producing crisp white sparkling light with high color rendering

Benefits

- High-intensity beam of crisp white sparkling light makes merchandise look irresistible
- Stable color and lumen output over life keeps your store attractive season after season
- Lowest Total Cost of Ownership as a result of high efficacy (same light, less energy or same energy, more light) and long life

Features

- Crisp white sparkling light
- Excellent color rendering, with extra red
- High efficacy with unparalleled lumen maintenance
- Stable color performance over lifetime
- UV-blocking glass

Application

- Accent and display lighting in retail
- General and decorative indoor lighting
- Outdoor area lighting

MASTERC colour CDM-T Elite

Warnings and Safety

- Use only in totally enclosed luminaire, even during testing (IEC61167, IEC 62035, IEC60598)
- The luminaire must be able to contain hot lamp parts if the lamp ruptures
- Use only with electronic control gear. 35W & 70W lamps may also use electromagnetic gear.
- Control gear must include end-of-life protection (IEC61167, IEC 62035)
- A lamp breaking is extremely unlikely to have any impact on your health. If a lamp breaks, ventilate the room for 30 minutes and remove the parts, preferably with gloves. Put them in a sealed plastic bag and take it to your local waste facilities for recycling. Do not use a vacuum cleaner.

Versions



LPPR_CDM-T-E_100W_G12-Product photo



LPPR_CDM-T_0005



LPPR_CDM-T-E_0005-Product photo



LPPR_CDM-T-E_0006-Product photo

Dimensional drawing

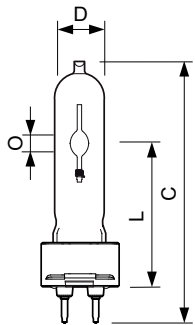
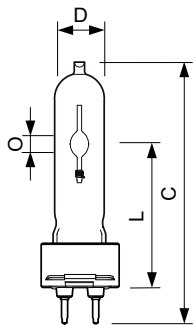

Product	D (max)	D O	L (min)	L (max)	L	C (max)
MASTERC CDM-T Elite 20W/830	20 mm	4 mm	55 mm	57 mm	56 mm	103 mm
G12 1CT/12						

Product	D (max)	O	L (min)	L (max)	L	C (max)
MASTERC CDM-T Elite	20 mm	8.5 mm	55 mm	57 mm	56 mm	110 mm
100W/930 G12 1CT/12						
MASTERC CDM-T Elite 35W/930	20 mm	4.8 mm	55 mm	57 mm	56 mm	103 mm
G12 1CT/12						
MASTERC CDM-T Elite 35W/942	20 mm	5.2 mm	55 mm	57 mm	56 mm	103 mm
G12 1CT						
MASTERC CDM-T Elite 50W/930	20 mm	6 mm	55 mm	57 mm	56 mm	103 mm
G12 1CT/12						
MASTERC CDM-T Elite 70W/930	20 mm	7.15 mm	55 mm	57 mm	56 mm	103 mm
G12 1CT/12						
MASTERC CDM-T Elite 70W/942	20 mm	7.75 mm	55 mm	57 mm	56 mm	103 mm
G12 1CT						

MASTERC colour CDM-T Elite

General Information	
Cap base	G12
Operating position	UNIVERSAL
Controls and Dimming	
Dimmable	No
Mechanical and Housing	
Lamp Finish	Clear
Bulb shape	T19

Light Technical

Order Code	Full Product Name	Chromaticity	Chromaticity	Colour designation	Correlated Colour	Colour	Luminous efficacy (rated) (nom.)	Luminous Flux
		Coordinate X (Nom)	Coordinate Y (Nom)		Temperature (Nom)	rendering index (CRI)		
928183205125	MASTERC CDM-T Elite 100W/930 G12 1CT/12	0.434	0.398	Warm White (WW)	3000 K	92	110 lm/W	11,000 lm
928183305125	MASTERC CDM-T Elite 20W/830 G12 1CT/12	0.434	0.398	Warm White (WW)	3000 K	84	90 lm/W	1,800 lm
928185205131	MASTERC CDM-T Elite 35W/930 G12 1CT/12	0.434	0.398	Warm White (WW)	3000 K	90	98 lm/W	4,050 lm
928193605131	MASTERC CDM-T Elite 35W/942 G12 1CT	0.371	0.366	Cool White (CW)	4200 K	90	98 lm/W	3,850 lm
928185305131	MASTERC CDM-T Elite 70W/930 G12 1CT/12	0.434	0.398	Warm White (WW)	3000 K	90	103 lm/W	7,800 lm
928193705131	MASTERC CDM-T Elite 70W/942 G12 1CT	0.371	0.366	Cool White (CW)	4200 K	90	100 lm/W	7,500 lm
928191705131	MASTERC CDM-T Elite 50W/930 G12 1CT/12	0.434	0.398	Warm White (WW)	3000 K	90	108 lm/W	5,450 lm

Operating and Electrical

Order Code	Full Product Name	Voltage (nom.)	Power Consumption	Order Code	Full Product Name	Voltage (nom.)	Power Consumption
928183205125	MASTERC CDM-T Elite 100W/930 G12 1CT/12	88 V	100.1 W	928185305131	MASTERC CDM-T Elite 70W/930 G12 1CT/12	85 V	73.2 W
928183305125	MASTERC CDM-T Elite 20W/830 G12 1CT/12	95 V	20.1 W	928193705131	MASTERC CDM-T Elite 70W/942 G12 1CT	87 V	73.2 W
928185205131	MASTERC CDM-T Elite 35W/930 G12 1CT/12	85 V	39.1 W	928191705131	MASTERC CDM-T Elite 50W/930 G12 1CT/12	90 V	50.2 W
928193605131	MASTERC CDM-T Elite 35W/942 G12 1CT	90 V	39.1 W				

Approval and Application

Order Code	Full Product Name	Energy consumption kWh/1,000 hours	Mercury (Hg) content (max.)	Mercury (Hg) content (nom.)	Order Code	Full Product Name	Energy consumption kWh/1,000 hours	Mercury (Hg) content (max.)	Mercury (Hg) content (nom.)
928183205125	MASTERC CDM-T Elite 100W/930 G12 1CT/12	101 kWh	10.1 mg	10.1 mg	928183305125	MASTERC CDM-T Elite 20W/830 G12 1CT/12	21 kWh	3.5 mg	3.5 mg

MASTERCoulour CDM-T Elite

Order Code	Full Product Name	Energy consumption kWh/1,000 hours	Mercury (Hg) content (max.)	Mercury (Hg) content (nom.)
928185205131	MASTERC CDM-T Elite 35W/930 G12 1CT/12	40 kWh	4.7 mg	4.7 mg
928193605131	MASTERC CDM-T Elite 35W/942 G12 1CT	40 kWh	4.9 mg	4.9 mg
928185305131	MASTERC CDM-T Elite 70W/930 G12 1CT/12	74 kWh	6.6 mg	6.6 mg
928193705131	MASTERC CDM-T Elite 70W/942 G12 1CT	74 kWh	6.6 mg	6.6 mg
928191705131	MASTERC CDM-T Elite 50W/930 G12 1CT/12	51 kWh	6.6 mg	6.6 mg

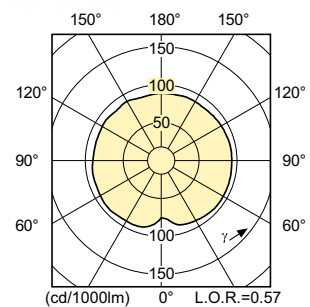
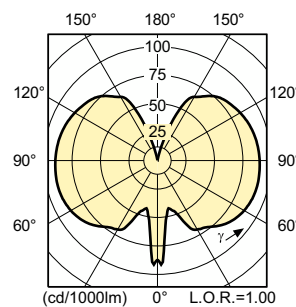
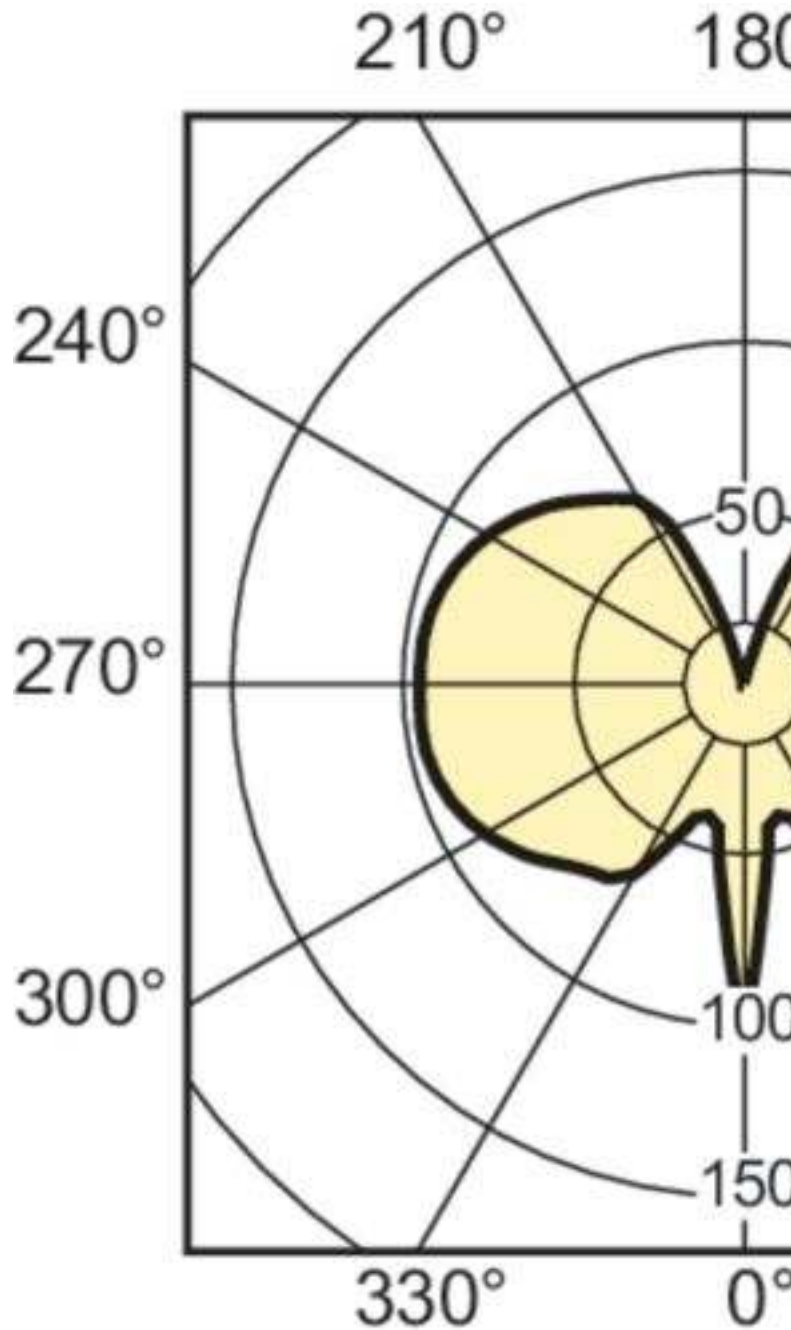
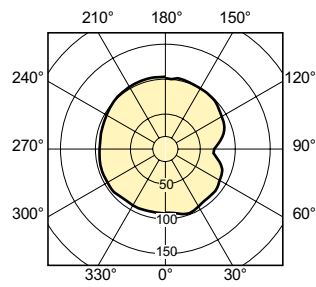
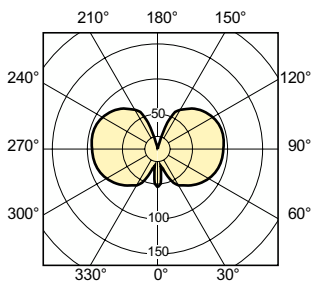

MASTERColour CDM-T Elite

