



Perfect sprankelend licht, gemakkelijke toepassing

MASTERColour CDM-Rm Elite Mini

Miniatuur keramische metaalhalogeen-reflectorontladingslamp met zeer hoog rendement die een sprankelend helder wit licht produceert met een hoge kleurweergave index

Voordelen

- Bundel van sprankelend wit licht met hoge intensiteit laat de koopwaar er onweerstaanbaar uitzien
- Gemakkelijk te installeren en vervangen, wat de installatie- en vervangingskosten verlaagt
- Past in kleine armaturen die minder zichtbaar zijn

Kenmerken

- Helder, sprankelend wit licht
- Uitstekende kleurweergave, met extra rood
- Hoog energierendement met weergaloos lumenbehoud
- Miniatuurontwerp past in open armaturen
- UV-blokkerend frontglas

Toepassing

- Accent- en displayverlichting in de detailhandel
- Algemene en decoratieve binnenverlichting

Waarschuwingen en veiligheid

- Alleen te gebruiken met elektronische VSA's
- Regel-VSA moet voorzien zijn van eindelevensduurbescherming (IEC 61167, IEC 62035)

MASTERCLOUR CDM-Rm Elite Mini

Maatschets

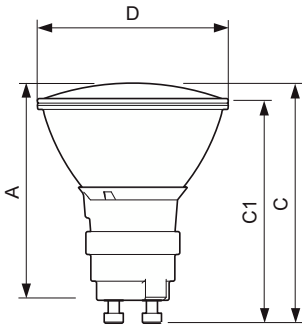

Product	D (max)	D	C (max)	C	C1 (max)	A (max)
CDM-Rm Elite Mini 20W/830 GX10 MR16 10D	51 mm	50 mm	65,4 mm	62,75 mm	60,9 mm	59 mm
CDM-Rm Elite Mini 20W/830 GX10 MR16 25D	51 mm	50 mm	65,4 mm	62,75 mm	60,9 mm	59 mm
CDM-Rm Elite Mini 20W/830 GX10 MR16 40D	51 mm	50 mm	65,4 mm	62,75 mm	60,9 mm	59 mm
CDM-Rm Elite Mini 35W/930 GX10 MR16 10D	51 mm	50 mm	65,4 mm	62,75 mm	60,9 mm	59 mm
CDM-Rm Elite Mini 35W/930 GX10 MR16 25D	51 mm	50 mm	65,4 mm	62,75 mm	60,9 mm	59 mm

Algemene informatie

Lampvoet	GX10
Schakelcyclus	1.350
Gebruiksstand	UNIVERSEEL

Gegevens lichttechniek

Kleurkwaliteit, coördinaat X (nominaal)	0,434
Kleurkwaliteit, coördinaat Y (nominaal)	0,398
Gecorreleerde kleurtemperatuur (nom.)	3000 K

Bedrijfs- en elektrische gegevens

Opwarmtijd tot 60% licht	120 s
--------------------------	-------

Dimbaarheid en regelsystemen

Dimbaar	Nee
---------	-----

Eigenschappen behuizing en afmetingen

Lampvorm	MR16
----------	------

Gegevens lichttechniek (1/2)

Order Code	Full Product Name	Bundelhoek (nom.)	Kleurweergave-index (CRI)	LLMF bij einde nominale levensduur (nom.)	Lichtrendement (gespec.) (nom.)
8718291202745	CDM-Rm Elite Mini 20W/830 GX10 MR16 10D	10 graden	84	70 %	49 lm/W
8718291203018	CDM-Rm Elite Mini 20W/830 GX10 MR16 25D	25 graden	84	70 %	50 lm/W
8718291203032	CDM-Rm Elite Mini 20W/830 GX10 MR16 40D	40 graden	84	70 %	50 lm/W
8718291162964	CDM-Rm Elite Mini 35W/930 GX10 MR16 10D	10 graden	90	80 %	60 lm/W
8718291163008	CDM-Rm Elite Mini 35W/930 GX10 MR16 25D	25 graden	90	80 %	60 lm/W

Gegevens lichttechniek (2/2)

Order Code	Full Product Name	Lichtstroom	Lichtsterkte (nom.)	Order Code	Full Product Name	Lichtstroom	Lichtsterkte (nom.)
8718291202745	CDM-Rm Elite Mini 20W/830 GX10 MR16 10D	880 lm	14.500 cd	8718291162964	CDM-Rm Elite Mini 35W/930 GX10 MR16 10D	2.100 lm	17.500 cd
8718291203018	CDM-Rm Elite Mini 20W/830 GX10 MR16 25D	900 lm	4.000 cd	8718291163008	CDM-Rm Elite Mini 35W/930 GX10 MR16 25D	2.150 lm	7.600 cd
8718291203032	CDM-Rm Elite Mini 20W/830 GX10 MR16 40D	860 lm	1.750 cd				

Bedrijfs- en elektrische gegevens

MASTERCLOUR CDM-Rm Elite Mini

Order Code	Full Product Name	Spanning (nom.)	Energieverbruik
8718291202745	CDM-Rm Elite Mini 20W/830 GX10 MR16 10D	95 V	20,1 W
8718291203018	CDM-Rm Elite Mini 20W/830 GX10 MR16 25D	95 V	20,1 W
8718291203032	CDM-Rm Elite Mini 20W/830 GX10 MR16 40D	95 V	20,1 W

Order Code	Full Product Name	Spanning (nom.)	Energieverbruik
8718291162964	CDM-Rm Elite Mini 35W/930 GX10 MR16 10D	87 V	39,1 W
8718291163008	CDM-Rm Elite Mini 35W/930 GX10 MR16 25D	87 V	39,1 W

Keurmerken en classificaties

Order Code	Full Product Name	Energieverbruik kWh/1.000 uur	Kwikhoud (Hg) (max.)	Kwikhoud (Hg) (nom.)
8718291202745	CDM-Rm Elite Mini 20W/830 GX10 MR16 10D	21 kWh	3,5 mg	3,5 mg
8718291203018	CDM-Rm Elite Mini 20W/830 GX10 MR16 25D	21 kWh	3,5 mg	3,5 mg
8718291203032	CDM-Rm Elite Mini 20W/830 GX10 MR16 40D	21 kWh	3,5 mg	3,5 mg
8718291162964	CDM-Rm Elite Mini 35W/930 GX10 MR16 10D	40 kWh	4,7 mg	4,7 mg
8718291163008	CDM-Rm Elite Mini 35W/930 GX10 MR16 25D	40 kWh	4,7 mg	4,7 mg

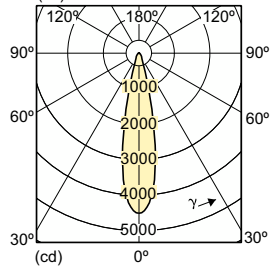
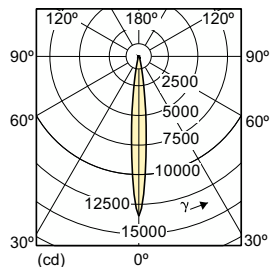
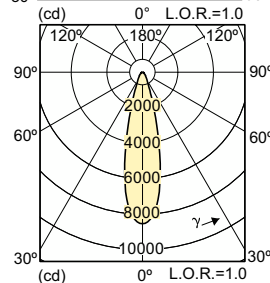
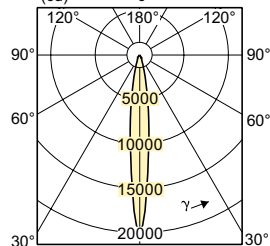
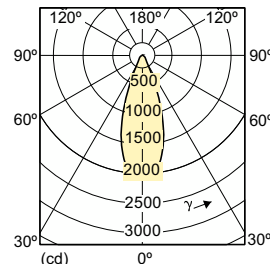

MASTERColour CDM-Rm Elite Mini

Accent Diagrams

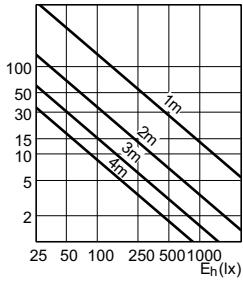

Accent Diagram - CDM-Rm Elite Mini 20W/830
GX10 MR16 10D

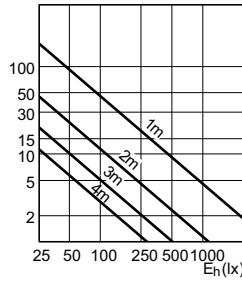

Accent Diagram - CDM-Rm Elite Mini 20W/830
GX10 MR16 25D

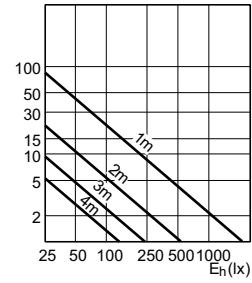

Accent Diagram - CDM-Rm Elite Mini 20W/830
GX10 MR16 40D

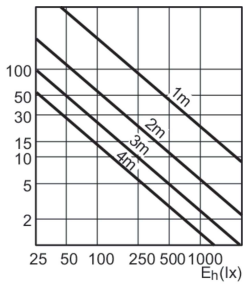

Accent Diagram - CDM-Rm Elite Mini 35W/930
GX10 MR16 10D

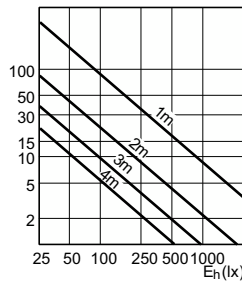

Accent Diagram - CDM-Rm Elite Mini 35W/930
GX10 MR16 25D

Beam Diagrams

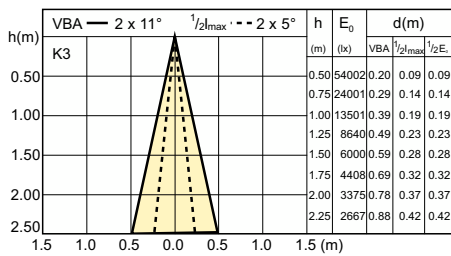

Beam diagram - CDM-Rm Elite Mini 20W/830
GX10 MR16 10D

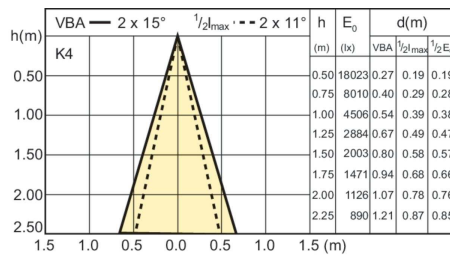

Beam diagram - CDM-Rm Elite Mini 20W/830
GX10 MR16 25D

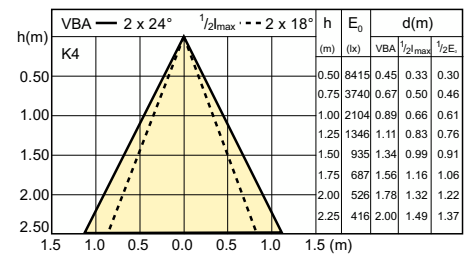

Beam diagram - CDM-Rm Elite Mini 20W/830
GX10 MR16 40D

MASTERColour CDM-Rm Elite Mini

Beam Diagrams

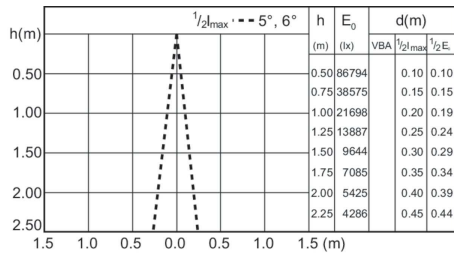

Beam diagram - CDM-Rm Elite Mini 35W/930
GX10 MR16 10D

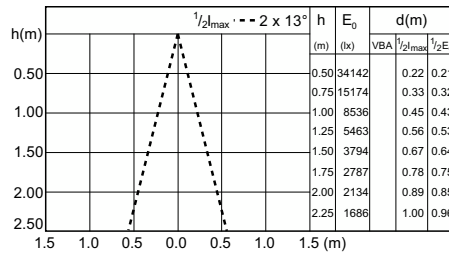

Beam diagram - CDM-Rm Elite Mini 35W/930
GX10 MR16 25D

