



Perfect sparkle, easy application

MASTERColour CDM-Rm Elite Mini

Mini, very high-efficiency Ceramic Metal Halide discharge reflector lamp producing crisp white sparkling light with high colour rendering

Benefits

- High-intensity beam of crisp white sparkling light makes merchandise look irresistible
- Easy to install and replace, reducing installation and relamping costs
- Fits in small luminaires which are less visible

Features

- Crisp white sparkling light
- Excellent colour rendering, with extra red
- High efficacy with unparalleled lumen maintenance
- Mini design fitting in open luminaires
- UV-blocking front glass

Application

- Accent and display lighting in retail
- General and decorative indoor lighting

Warnings and Safety

- Use only with electronic control gear
- Control gear must include end-of-life protection (IEC61167, IEC 62035)

MASTERCLOUR CDM-Rm Elite Mini

Dimensional drawing

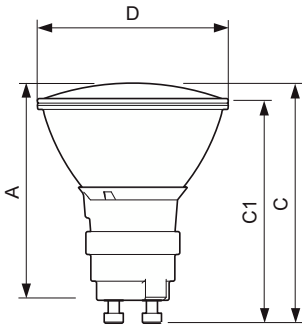

Product	D (max)	D	C (max)	C	C1 (max)	A (max)
CDM-Rm Elite Mini 20W/830 GX10 MR16 10D	51 mm	50 mm	65.4 mm	62.75 mm	60.9 mm	59 mm
CDM-Rm Elite Mini 20W/830 GX10 MR16 25D	51 mm	50 mm	65.4 mm	62.75 mm	60.9 mm	59 mm
CDM-Rm Elite Mini 20W/830 GX10 MR16 40D	51 mm	50 mm	65.4 mm	62.75 mm	60.9 mm	59 mm
CDM-Rm Elite Mini 35W/930 GX10 MR16 10D	51 mm	50 mm	65.4 mm	62.75 mm	60.9 mm	59 mm
CDM-Rm Elite Mini 35W/930 GX10 MR16 25D	51 mm	50 mm	65.4 mm	62.75 mm	60.9 mm	59 mm

General Information	
Cap base	GX10
Switching Cycle	1,350
Operating position	UNIVERSAL
Light Technical	
Chromaticity Coordinate X (Nom)	0.434
Chromaticity Coordinate Y (Nom)	0.398
Correlated Colour Temperature (Nom)	3000 K
Operating and Electrical	
Warm-up time to 60% light	120 s
Controls and Dimming	
Dimmable	No
Mechanical and Housing	
Bulb shape	MR16

Light Technical (1/2)

Order Code	Full Product Name	Beam angle (nom.)	Colour rendering index (CRI)	LLMF at end of nominal lifetime (nom.)	Luminous efficacy (rated) (nom.)
928191005331	CDM-Rm Elite Mini 20W/830 GX10 MR16 10D	10 degree(s)	84	70 %	49 lm/W
928191105331	CDM-Rm Elite Mini 20W/830 GX10 MR16 25D	25 degree(s)	84	70 %	50 lm/W
928191205331	CDM-Rm Elite Mini 20W/830 GX10 MR16 40D	40 degree(s)	84	70 %	50 lm/W
928194605330	CDM-Rm Elite Mini 35W/930 GX10 MR16 10D	10 degree(s)	90	80 %	60 lm/W
928194705330	CDM-Rm Elite Mini 35W/930 GX10 MR16 25D	25 degree(s)	90	80 %	60 lm/W

Light Technical (2/2)

Order Code	Full Product Name	Luminous Flux	Luminous intensity (nom.)	Order Code	Full Product Name	Luminous Flux	Luminous intensity (nom.)
928191005331	CDM-Rm Elite Mini 20W/830 GX10 MR16 10D	880 lm	14,500 cd	928194605330	CDM-Rm Elite Mini 35W/930 GX10 MR16 10D	2,100 lm	17,500 cd
928191105331	CDM-Rm Elite Mini 20W/830 GX10 MR16 25D	900 lm	4,000 cd	928194705330	CDM-Rm Elite Mini 35W/930 GX10 MR16 25D	2,150 lm	7,600 cd
928191205331	CDM-Rm Elite Mini 20W/830 GX10 MR16 40D	860 lm	1,750 cd				

Operating and Electrical

Order Code	Full Product Name	Voltage (nom.)	Power Consumption	Order Code	Full Product Name	Voltage (nom.)	Power Consumption
928191005331	CDM-Rm Elite Mini 20W/830 GX10 MR16 10D	95 V	20.1 W	928191105331	CDM-Rm Elite Mini 20W/830 GX10 MR16 25D	95 V	20.1 W

MASTERColour CDM-Rm Elite Mini

Order Code	Full Product Name	Voltage (nom.)	Power Consumption
928191205331	CDM-Rm Elite Mini 20W/830 GX10 MR16 40D	95 V	20.1 W
928194605330	CDM-Rm Elite Mini 35W/930 GX10 MR16 10D	87 V	39.1 W

Order Code	Full Product Name	Voltage (nom.)	Power Consumption
928194705330	CDM-Rm Elite Mini 35W/930 GX10 MR16 25D	87 V	39.1 W

Approval and Application

Order Code	Full Product Name	Energy consumption kWh/1,000 hours	Mercury (Hg) content (max.)	Mercury (Hg) content (nom.)
928191005331	CDM-Rm Elite Mini 20W/830 GX10 MR16 10D	21 kWh	3.5 mg	3.5 mg
928191105331	CDM-Rm Elite Mini 20W/830 GX10 MR16 25D	21 kWh	3.5 mg	3.5 mg
928191205331	CDM-Rm Elite Mini 20W/830 GX10 MR16 40D	21 kWh	3.5 mg	3.5 mg
928194605330	CDM-Rm Elite Mini 35W/930 GX10 MR16 10D	40 kWh	4.7 mg	4.7 mg
928194705330	CDM-Rm Elite Mini 35W/930 GX10 MR16 25D	40 kWh	4.7 mg	4.7 mg

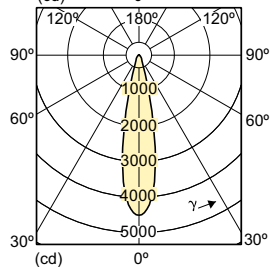
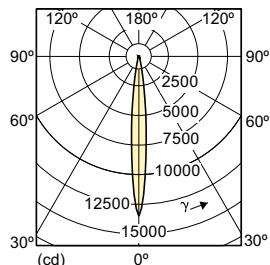
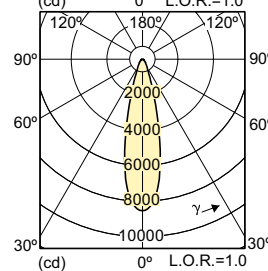
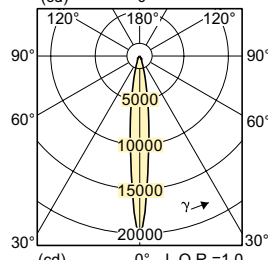
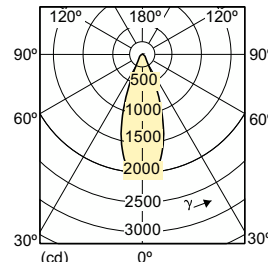

MASTERColour CDM-Rm Elite Mini

Accent Diagrams

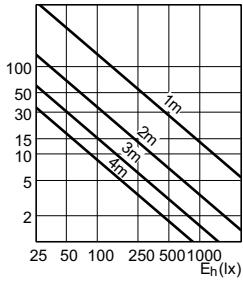

Accent Diagram - CDM-Rm Elite Mini 20W/830
GX10 MR16 10D

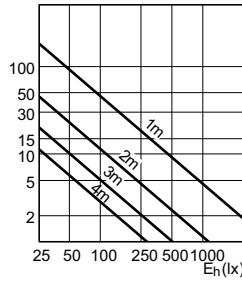

Accent Diagram - CDM-Rm Elite Mini 20W/830
GX10 MR16 25D

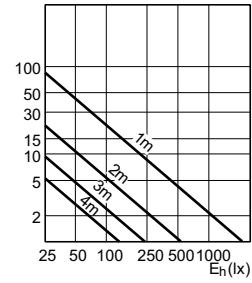

Accent Diagram - CDM-Rm Elite Mini 20W/830
GX10 MR16 40D

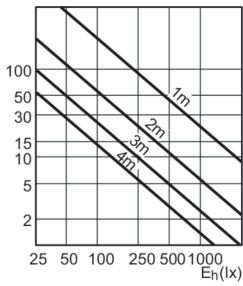

Accent Diagram - CDM-Rm Elite Mini 35W/930
GX10 MR16 10D

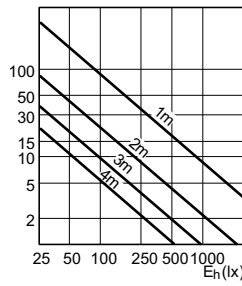

Accent Diagram - CDM-Rm Elite Mini 35W/930
GX10 MR16 25D

Beam Diagrams

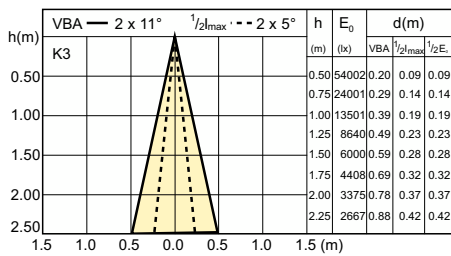

Beam diagram - CDM-Rm Elite Mini 20W/830
GX10 MR16 10D

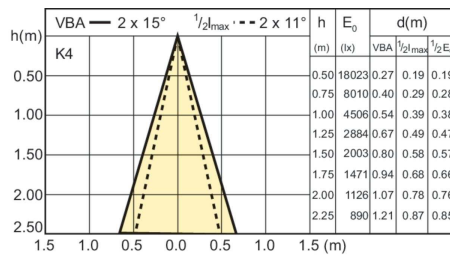

Beam diagram - CDM-Rm Elite Mini 20W/830
GX10 MR16 25D

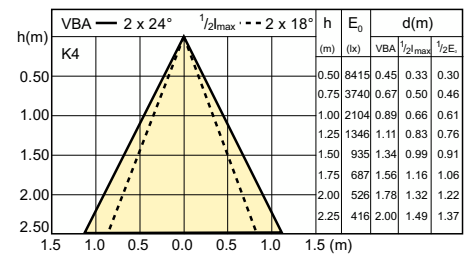

Beam diagram - CDM-Rm Elite Mini 20W/830
GX10 MR16 40D

MASTERColour CDM-Rm Elite Mini

Beam Diagrams

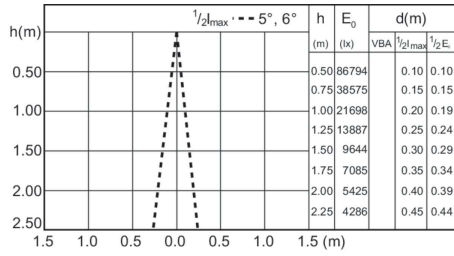

Beam diagram - CDM-Rm Elite Mini 35W/930
GX10 MR16 10D

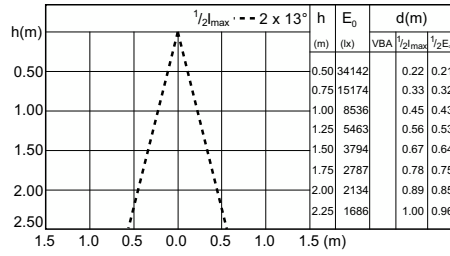

Beam diagram - CDM-Rm Elite Mini 35W/930
GX10 MR16 25D

