



# Perfect sparkle, easy application

## MASTERColour CDM-Rm Elite Mini

Mini, very high-efficiency Ceramic Metal Halide discharge reflector lamp producing crisp white sparkling light with high color rendering

### Benefits

- High-intensity beam of crisp white sparkling light makes merchandise look irresistible
- Easy to install and replace, reducing installation and relamping costs
- Fits in small luminaires which are less visible

### Features

- Crisp white sparkling light
- Excellent color rendering, with extra red
- High efficacy with unparalleled lumen maintenance
- Mini design fitting in open luminaires
- UV-blocking front glass

### Application

- Accent and display lighting in retail
- General and decorative indoor lighting

### Warnings and Safety

- Use only with electronic control gear
- Control gear must include end-of-life protection (IEC61167, IEC 62035).
- A lamp breaking is extremely unlikely to have any impact on your health. If a lamp breaks, ventilate the room for 30 minutes and remove the parts, preferably with gloves. Put them in a sealed plastic bag and take it to your local waste facilities for recycling. Do not use a vacuum cleaner.

# MASTERCcolour CDM-Rm Elite Mini

## Dimensional drawing

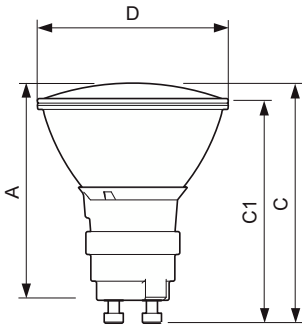

| Product                                 | D (max) | D     | C (max) | C        | C1 (max) | A (max) |
|---|---------|-------|---------|----------|----------|---------|
| CDM-Rm Elite Mini 20W/830 GX10 MR16 10D | 51 mm   | 50 mm | 65.4 mm | 62.75 mm | 60.9 mm  | 59 mm   |
| CDM-Rm Elite Mini 20W/830 GX10 MR16 25D | 51 mm   | 50 mm | 65.4 mm | 62.75 mm | 60.9 mm  | 59 mm   |
| CDM-Rm Elite Mini 35W/930 GX10 MR16 10D | 51 mm   | 50 mm | 65.4 mm | 62.75 mm | 60.9 mm  | 59 mm   |
| CDM-Rm Elite Mini 35W/930 GX10 MR16 25D | 51 mm   | 50 mm | 65.4 mm | 62.75 mm | 60.9 mm  | 59 mm   |

| General Information                |           |
|------------------------------------|-----------|
| Cap-Base                           | GX10      |
| Switching Cycle                    | 1,350     |
| Operating Position                 | UNIVERSAL |
| Light Technical                    |           |
| Chromaticity Coordinate X (Nom)    | 0.434     |
| Chromaticity Coordinate Y (Nom)    | 0.398     |
| Correlated Color Temperature (Nom) | 3000 K    |
| Operating and Electrical           |           |
| Warm-up time to 60% light          | 120 s     |
| Controls and Dimming               |           |
| Dimmable                           | No        |
| Mechanical and Housing             |           |
| Bulb Shape                         | MR16      |

## Light Technical (1/2)

| Order Code | Full Product Name                                     | Beam Angle (Nom) | LLMF At End                 |                           |                                 |
|------------|---|------------------|-----------------------------|---------------------------|---------------------------------|
|            |   |                  | Color rendering index (CRI) | Of Nominal Lifetime (Nom) | Luminous Efficacy (rated) (Nom) |
| 20274500   | MASTERCcolour CDM-Rm Elite Mini 20W/830 GX10 MR16 10D | 10 degree(s)     | 84                          | 70 %                      | 49 lm/W                         |
| 20301800   | MASTERCcolour CDM-Rm Elite Mini 20W/830 GX10 MR16 25D | 25 degree(s)     | 84                          | 70 %                      | 50 lm/W                         |
| 16296400   | MASTERCcolour CDM-Rm Elite Mini 35W/930 GX10 MR16 10D | 10 degree(s)     | 90                          | 80 %                      | 60 lm/W                         |
| 16300800   | MASTERCcolour CDM-Rm Elite Mini 35W/930 GX10 MR16 25D | 25 degree(s)     | 90                          | 80 %                      | 60 lm/W                         |

## Light Technical (2/2)

| Order Code | Full Product Name                                     | Luminous      |                 | Order Code | Full Product Name                                     | Luminous      |                 |
|------------|---|---------------|-----------------|------------|---|---------------|-----------------|
|            |   | Luminous Flux | Intensity (Nom) |            |   | Luminous Flux | Intensity (Nom) |
| 20274500   | MASTERCcolour CDM-Rm Elite Mini 20W/830 GX10 MR16 10D | 880 lm        | 14,500 cd       | 16296400   | MASTERCcolour CDM-Rm Elite Mini 35W/930 GX10 MR16 10D | 2,100 lm      | 17,500 cd       |
| 20301800   | MASTERCcolour CDM-Rm Elite Mini 20W/830 GX10 MR16 25D | 900 lm        | 4,000 cd        | 16300800   | MASTERCcolour CDM-Rm Elite Mini 35W/930 GX10 MR16 25D | 2,150 lm      | 7,600 cd        |

## Operating and Electrical

| Order Code | Full Product Name                                     | Voltage | Power       | Order Code | Full Product Name                                     | Voltage | Power       |
|------------|---|---------|-------------|------------|---|---------|-------------|
|            |   | (Nom)   | Consumption |            |   | (Nom)   | Consumption |
| 20274500   | MASTERCcolour CDM-Rm Elite Mini 20W/830 GX10 MR16 10D | 95 V    | 20.1 W      | 16296400   | MASTERCcolour CDM-Rm Elite Mini 35W/930 GX10 MR16 10D | 87 V    | 39.1 W      |
| 20301800   | MASTERCcolour CDM-Rm Elite Mini 20W/830 GX10 MR16 25D | 95 V    | 20.1 W      | 16300800   | MASTERCcolour CDM-Rm Elite Mini 35W/930 GX10 MR16 25D | 87 V    | 39.1 W      |

## Approval and Application

# MASTERColour CDM-Rm Elite Mini

| Order Code | Full Product Name  | Energy Consumption<br>kWh/1000 h | Mercury<br>(Hg)<br>Content<br>(Max) | Mercury<br>(Hg)<br>Content<br>(Nom) |
|------------|--|----------------------------------|-------------------------------------|-------------------------------------|
| 20274500   | MASTERColour CDM-Rm<br>Elite Mini 20W/830 GX10<br>MR16 10D | 21 kWh                           | 3.5 mg                              | 3.5 mg                              |
| 20301800   | MASTERColour CDM-Rm<br>Elite Mini 20W/830 GX10<br>MR16 25D | 21 kWh                           | 3.5 mg                              | 3.5 mg                              |
| 16296400   | MASTERColour CDM-Rm<br>Elite Mini 35W/930 GX10<br>MR16 10D | 40 kWh                           | 4.7 mg                              | 4.7 mg                              |
| 16300800   | MASTERColour CDM-Rm<br>Elite Mini 35W/930 GX10<br>MR16 25D | 40 kWh                           | 4.7 mg                              | 4.7 mg                              |

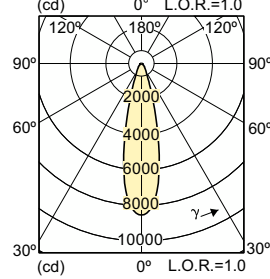
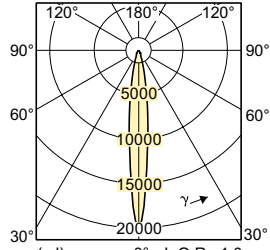
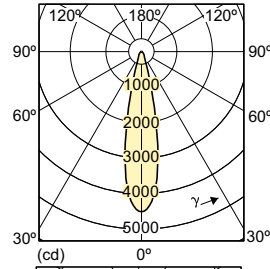
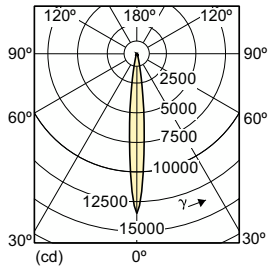

## Accent Diagrams

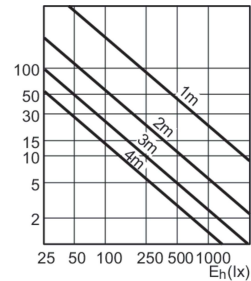
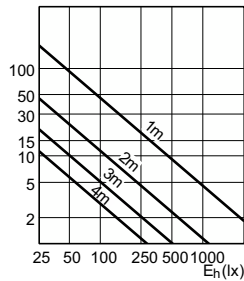
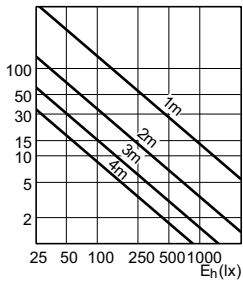

Accent Diagram - CDM-Rm Elite Mini 20W/830  
GX10 MR16 10D

Accent Diagram - CDM-Rm Elite Mini 20W/830  
GX10 MR16 25D

Accent Diagram - CDM-Rm Elite Mini 35W/930  
GX10 MR16 10D

# MASTERColour CDM-Rm Elite Mini

## Accent Diagrams

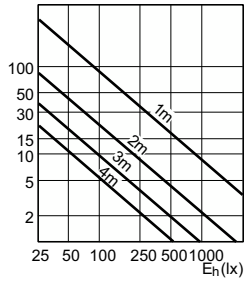

Accent Diagram - CDM-Rm Elite Mini 35W/930  
GX10 MR16 25D

## Beam Diagrams

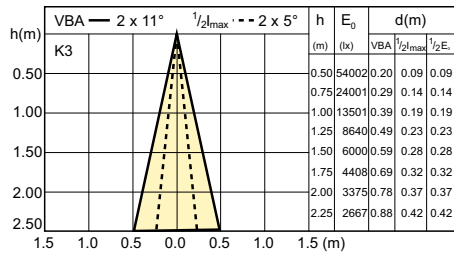

Beam diagram - CDM-Rm Elite Mini 20W/830  
GX10 MR16 10D

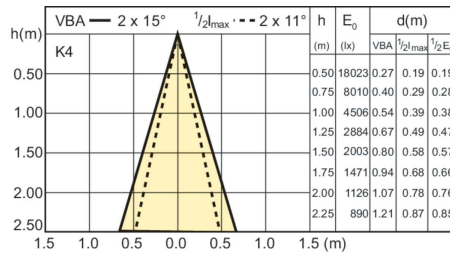

Beam diagram - CDM-Rm Elite Mini 20W/830  
GX10 MR16 25D

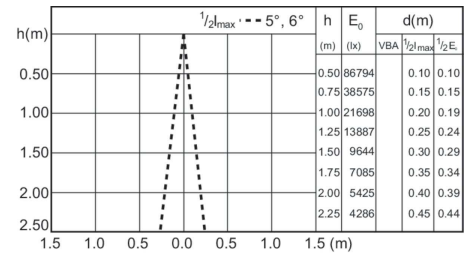

Beam diagram - CDM-Rm Elite Mini 35W/930  
GX10 MR16 10D

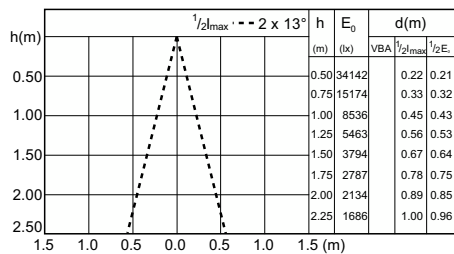

Beam diagram - CDM-Rm Elite Mini 35W/930  
GX10 MR16 25D

## MASTERColour CDM-Rm Elite Mini

