



# Cenovo dostupné riešenie LEDspot

## CorePro LED spot LV

Svetelné zdroje CorePro LEDspot sú ideálne na bodové osvetlenie a vytvárajú teplé svetlo podobné halogénovému svetlu. Sú vhodné do väčšiny existujúcich svietidiel MR16 s objímkou GU5.3 a slúžia ako priama náhrada halogénových alebo klasických reflektorových žiaroviek. CorePro LEDspots zabezpečujú obrovskú úsporu elektrickej energie a minimalizujú náklady na údržbu.

### Výhody

- Úspora energie až 80 % v porovnaní s halogénovými žiarovkami
- Nižšie náklady na údržbu
- Široká kompatibilita s transformátormi

### Vlastnosti

- Jednoduchá výmena
- Životnosť 15 000 hodín
- Svetlo bez ultrafialového a infračerveného žiarenia
- Bez obsahu ortuti a nebezpečných materiálov

### Aplikácie

- Hotely, reštaurácie, bary, kaviarne, múzeá, obchody
- Vstupné haly, chodby, schodiská, toalety, recepcie, výstavy, vitríny

# CorePro LED spot LV

## Versions



CorePro LEDspot LV 35W GU5-3  
827 36D ND



MASTER LEDspot LV 35W GU5-3  
827 36D VLE



LEDspots Corepro SLR 2 MR16  
GU5,3



LEDspot GU4 Classic MR11

## Rozmerový obrázok

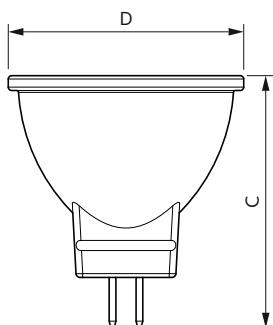
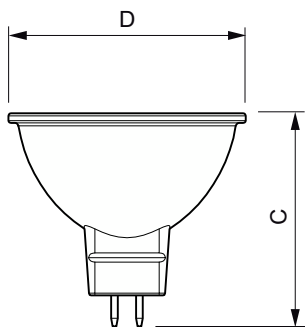

Product	D	C
CorePro LED spot ND 2.9-20W MR16 827 36D	50,5 mm	45,5 mm
CorePro LED spot ND 4.4-35W MR16 827 36D	50,5 mm	45,5 mm
CorePro LED spot ND 4.4-35W MR16 840 36D	50,5 mm	45,5 mm
CorePro LED spot ND 7-50W MR16 827 36D	50,5 mm	45 mm
CorePro LED spot ND 7-50W MR16 830 36D	50,5 mm	45 mm
CorePro LED spot ND 7-50W MR16 840 36D	50,5 mm	45 mm

Product	D	C
CorePro LED spot 2.3-20W 827 MR11 36D	35,5 mm	39,5 mm

# CorePro LED spot LV

## Všeobecné informácie

Spínací cyklus	50 000
----------------	--------

## Svetelné technické

Uhol vyžarovania (nom.)	36 stupeň (stupne)
-------------------------	-----------------------

Index podania farieb (CRI)	80
----------------------------	----

LLMF na konci nominálnej životnosti (nom.)	70 %
--	------

## Prevádzkové a elektrické

Vstupná frekvencia	- Hz
--------------------	------

Sieťová frekvencia	- Hz
--------------------	------

Čas spustenia (nom.)	0,5 s
----------------------	-------

## Ovládanie a stmievanie

Stmievateľné	Nie
--------------	-----

## Mechanické časti a teleso

Povrchová úprava žiarovky	Číra
---------------------------	------

## Schválenie a použitie

Rozsah okolitých teplôt	-20 až +40 °C
-------------------------	---------------

## Všeobecné informácie

Order Code	Full Product Name	Pätica	Nominálna životnosť
30706300	CorePro LED spot ND 4.4-35W MR16 827 36D	GU5.3	15 000 h
30708700	CorePro LED spot ND 4.4-35W MR16 840 36D	GU5.3	15 000 h
81471000	CorePro LED spot ND 7-50W MR16 827 36D	GU5.3	15 000 h
81477200	CorePro LED spot ND 7-50W MR16 830 36D	GU5.3	15 000 h
81479600	CorePro LED spot ND 7-50W MR16 840 36D	GU5.3	15 000 h
30704900	CorePro LED spot ND 2.9-20W MR16 827 36D	GU5.3	15 000 h
65948600	CorePro LED spot 2.3-20W 827 MR11 36D	GU4	25 000 h

## Svetelné technické

Order Code	Full Product Name	Náhradná teplota		Svetelný tok	Intenzita svetla (nom.)
		chromatickosti (nom.)	Kód farby		
30706300	CorePro LED spot ND 4.4-35W MR16 827 36D	2700 K	827	345 lm	650 cd
30708700	CorePro LED spot ND 4.4-35W MR16 840 36D	4000 K	840	390 lm	750 cd
81471000	CorePro LED spot ND 7-50W MR16 827 36D	2700 K	827	621 lm	1 400 cd
81477200	CorePro LED spot ND 7-50W MR16 830 36D	3000 K	830	621 lm	1 400 cd

Order Code	Full Product Name	Náhradná teplota		Svetelný tok	Intenzita svetla (nom.)
		chromatickosti (nom.)	Kód farby		
81479600	CorePro LED spot ND 7-50W MR16 840 36D	4000 K	840	660 lm	1 500 cd
30704900	CorePro LED spot ND 2.9-20W MR16 827 36D	2700 K	827	230 lm	560 cd
65948600	CorePro LED spot 2.3-20W 827 MR11 36D	2700 K	827	184 lm	400 cd

## Prevádzkové a elektrické

Order Code	Full Product Name	Spotreba	Ekvivalentný výkon
30706300	CorePro LED spot ND 4.4-35W MR16 827 36D	4,4 W	35 W
30708700	CorePro LED spot ND 4.4-35W MR16 840 36D	4,4 W	35 W
81471000	CorePro LED spot ND 7-50W MR16 827 36D	7 W	50 W
81477200	CorePro LED spot ND 7-50W MR16 830 36D	7 W	50 W

Order Code	Full Product Name	Spotreba	Ekvivalentný výkon
81479600	CorePro LED spot ND 7-50W MR16 840 36D	7 W	50 W
30704900	CorePro LED spot ND 2.9-20W MR16 827 36D	2,9 W	20 W
65948600	CorePro LED spot 2.3-20W 827 MR11 36D	2,3 W	20 W

# CorePro LED spot LV

## Teplota

Order Code	Full Product Name	Maximálna teplota krytu (nom.)
30706300	CorePro LED spot ND 4.4-35W MR16 827 36D	85 °C
30708700	CorePro LED spot ND 4.4-35W MR16 840 36D	85 °C
81471000	CorePro LED spot ND 7-50W MR16 827 36D	85 °C
81477200	CorePro LED spot ND 7-50W MR16 830 36D	85 °C

Order Code	Full Product Name	Maximálna teplota krytu (nom.)
81479600	CorePro LED spot ND 7-50W MR16 840 36D	85 °C
30704900	CorePro LED spot ND 2.9-20W MR16 827 36D	75 °C
65948600	CorePro LED spot 2.3-20W 827 MR11 36D	60 °C

## Mechanické časti a teleso

Order Code	Full Product Name	Tvar žiarovky
30706300	CorePro LED spot ND 4.4-35W MR16 827 36D	MR16
30708700	CorePro LED spot ND 4.4-35W MR16 840 36D	MR16
81471000	CorePro LED spot ND 7-50W MR16 827 36D	MR16
81477200	CorePro LED spot ND 7-50W MR16 830 36D	MR16

Order Code	Full Product Name	Tvar žiarovky
81479600	CorePro LED spot ND 7-50W MR16 840 36D	MR16
30704900	CorePro LED spot ND 2.9-20W MR16 827 36D	MR16
65948600	CorePro LED spot 2.3-20W 827 MR11 36D	MR11

## Schválenie a použitie

Order Code	Full Product Name	Spotreba energie kWh/1 000 h
30706300	CorePro LED spot ND 4.4-35W MR16 827 36D	5 kWh
30708700	CorePro LED spot ND 4.4-35W MR16 840 36D	5 kWh
81471000	CorePro LED spot ND 7-50W MR16 827 36D	7 kWh
81477200	CorePro LED spot ND 7-50W MR16 830 36D	7 kWh
81479600	CorePro LED spot ND 7-50W MR16 840 36D	7 kWh
30704900	CorePro LED spot ND 2.9-20W MR16 827 36D	3 kWh
65948600	CorePro LED spot 2.3-20W 827 MR11 36D	3 kWh

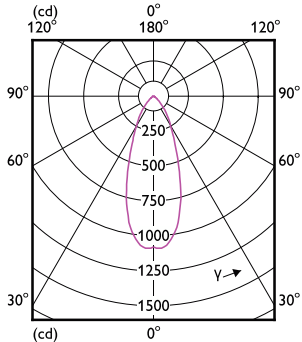
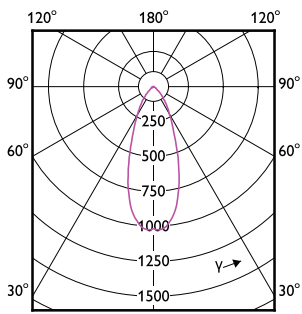
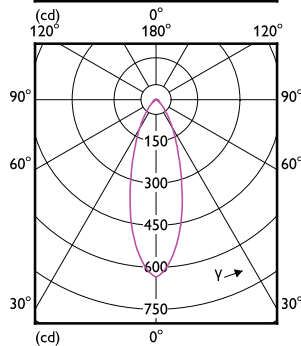
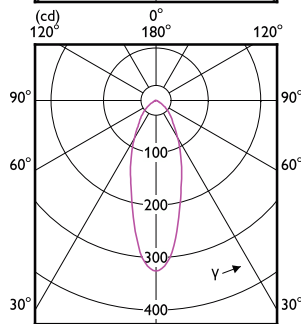
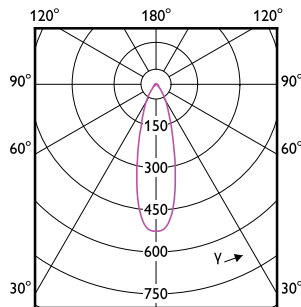

# CorePro LED spot LV

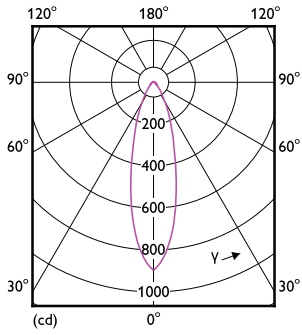

## Accent Diagrams

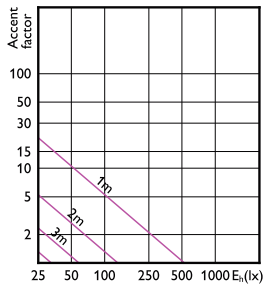

Accent Diagram - CorePro LED spot ND  
2.9-20W MR16 827 36D

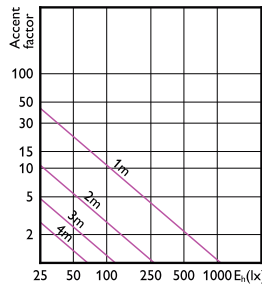

Accent Diagram - CorePro LED spot ND 7-50W  
MR16 840 36D

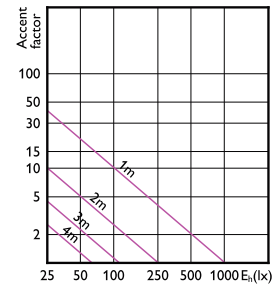

Accent Diagram - CorePro LED spot ND 7-50W  
MR16 827 36D

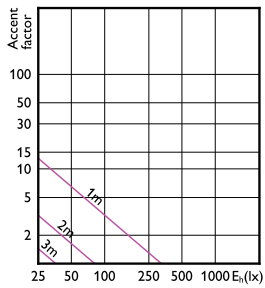

Accent Diagram - CorePro LED spot 2.3-20W  
827 MR11 36D

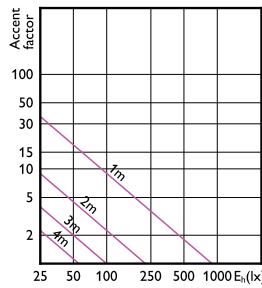

Accent Diagram - CorePro LED spot ND  
4.4-35W MR16 840 36D

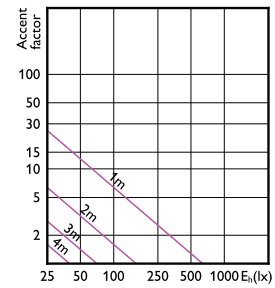

Accent Diagram - CorePro LED spot ND  
4.4-35W MR16 827 36D

## Beam Diagrams

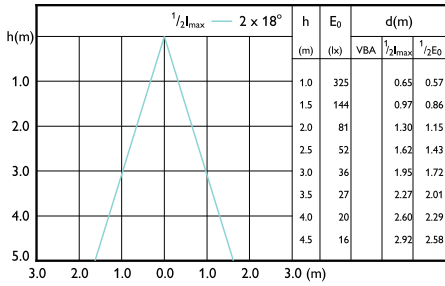

Beam diagram - CorePro LED spot 2.3-20W 827 MR11 36D

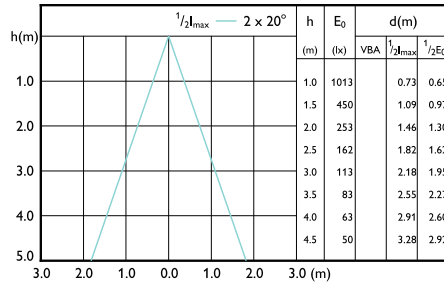

Beam diagram - CorePro LED spot ND 7-50W MR16 827 36D

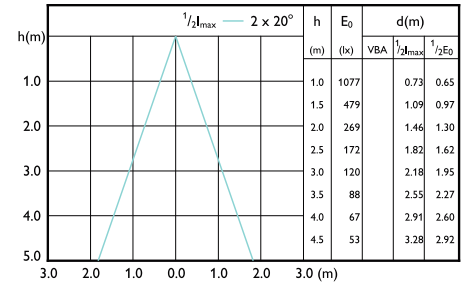

Beam diagram - CorePro LED spot ND 7-50W MR16 840 36D

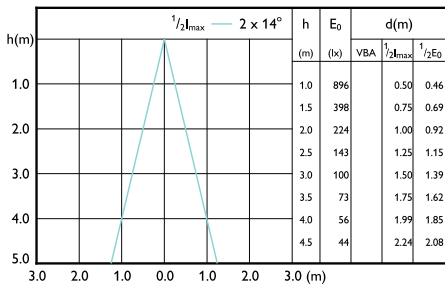

Beam diagram - CorePro LED spot ND 4.4-35W MR16 840 36D

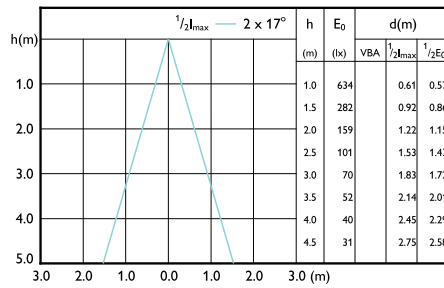

Beam diagram - CorePro LED spot ND 4.4-35W MR16 827 36D

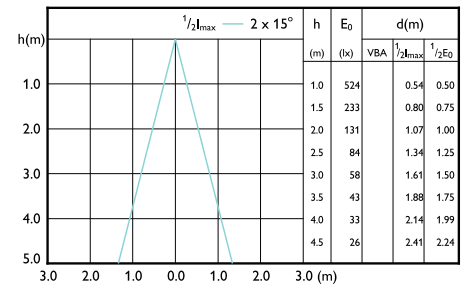

Beam diagram - CorePro LED spot ND 2.9-20W MR16 827 36D

