



The affordable LEDspot solution

CorePro LED spot LV

CorePro LEDspots are a perfect fit for spot lighting and deliver warm halogen-like light. They are compatible with most existing fixtures with MR16 GU5.3 holders and are designed as a retrofit replacement for halogen or incandescent spots. LEDlamps deliver huge energy savings and minimize maintenance cost.

Benefits

- Warm white light
- Up to 80% energy saving compared with halogen lamps
- Lower maintenance costs
- Broad compatibility with transformers

Features

- Easy retrofit
- Lifetime of 25,000 to 45,000 hours
- Compatible with an extensive range of dimmers
- UV- and IR-free light
- Free of mercury and hazardous materials

Application

- Hotels, restaurants, bars, cafés, museums, shops
- Lobbies, corridors, stairwells, washrooms, reception areas , exhibitions, display cabinets

CorePro LED spot LV

Versions



LEDspot GU4 Classic MR11

Dimensional drawing

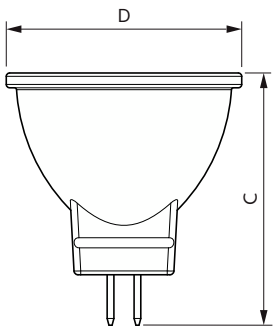
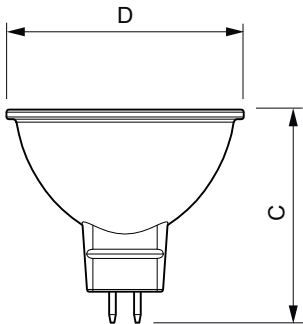

Product	D	C
CorePro LED spot ND 4.4-35W MR16 827 36D	50.5 mm	45.5 mm
CorePro LED spot ND 4.4-35W MR16 840 36D	50.5 mm	45.5 mm
CorePro LED spot ND 7-50W MR16 827 36D	50.5 mm	45 mm
CorePro LED spot ND 7-50W MR16 830 36D	50.5 mm	45 mm
CorePro LED spot ND 7-50W MR16 840 36D	50.5 mm	45 mm
CorePro LED spot ND4.4-35W MR16 827 36DUK	50.5 mm	45.5 mm
CorePro LED spot ND4.4-35W MR16 840 36DUK	50.5 mm	45.5 mm

Product	D	C
CorePro LED spot 2.3-20W 827 MR11 36D	35.5 mm	39.5 mm

CorePro LED spot LV

General Information

Switching Cycle	50,000
-----------------	--------

Light Technical

Beam angle (nom.)	36 degree(s)
Colour rendering index (CRI)	80
LLMF at end of nominal lifetime (nom.)	70 %

Operating and Electrical

Input frequency	- Hz
Line Frequency	- Hz
Starting time (nom.)	0.5 s

Controls and Dimming

Dimmable	No
----------	----

Approval and Application

Ambient temperature range	-20 to +40 °C
---------------------------	---------------

General Information

Order Code	Full Product Name	Cap base	Nominal lifetime
929002494602	CorePro LED spot ND 4.4-35W MR16 827 36D	GU5.3	15,000 h
929002494699	CorePro LED spot ND4.4-35W MR16 827 36DUK	GU5.3	15,000 h
929002494702	CorePro LED spot ND 4.4-35W MR16 840 36D	GU5.3	15,000 h
929002494799	CorePro LED spot ND4.4-35W MR16 840 36DUK	GU5.3	15,000 h
929001904802	CorePro LED spot ND 7-50W MR16 827 36D	GU5.3	15,000 h
929001904902	CorePro LED spot ND 7-50W MR16 830 36D	GU5.3	15,000 h
929001905002	CorePro LED spot ND 7-50W MR16 840 36D	GU5.3	15,000 h
929002066402	CorePro LED spot 2.3-20W 827 MR11 36D	GU4	25,000 h

Light Technical

Order Code	Full Product Name	Correlated Colour Temperature		Luminous Flux	Luminous intensity (nom.)
		(Nom)	Code		
929002494602	CorePro LED spot ND 4.4-35W MR16 827 36D	2700 K	827	345 lm	650 cd
929002494699	CorePro LED spot ND4.4-35W MR16 827 36DUK	2700 K	827	345 lm	650 cd
929002494702	CorePro LED spot ND 4.4-35W MR16 840 36D	4000 K	840	390 lm	750 cd
929002494799	CorePro LED spot ND4.4-35W MR16 840 36DUK	4000 K	840	390 lm	750 cd

Order Code	Full Product Name	Correlated Colour Temperature		Luminous Flux	Luminous intensity (nom.)
		(Nom)	Code		
929001904802	CorePro LED spot ND 7-50W MR16 827 36D	2700 K	827	621 lm	1,400 cd
929001904902	CorePro LED spot ND 7-50W MR16 830 36D	3000 K	830	621 lm	1,400 cd
929001905002	CorePro LED spot ND 7-50W MR16 840 36D	4000 K	840	660 lm	1,500 cd
929002066402	CorePro LED spot 2.3-20W 827 MR11 36D	2700 K	827	184 lm	400 cd

Operating and Electrical

Order Code	Full Product Name	Power Consumption	Wattage equivalent
929002494602	CorePro LED spot ND 4.4-35W MR16 827 36D	4.4 W	35 W
929002494699	CorePro LED spot ND4.4-35W MR16 827 36DUK	4.4 W	35 W
929002494702	CorePro LED spot ND 4.4-35W MR16 840 36D	4.4 W	35 W
929002494799	CorePro LED spot ND4.4-35W MR16 840 36DUK	4.4 W	35 W

Order Code	Full Product Name	Power Consumption	Wattage equivalent
929001904802	CorePro LED spot ND 7-50W MR16 827 36D	7 W	50 W
929001904902	CorePro LED spot ND 7-50W MR16 830 36D	7 W	50 W
929001905002	CorePro LED spot ND 7-50W MR16 840 36D	7 W	50 W
929002066402	CorePro LED spot 2.3-20W 827 MR11 36D	2.3 W	20 W

Temperature

CorePro LED spot LV

Order Code	Full Product Name	T-Case maximum (nom.)
929002494602	CorePro LED spot ND 4.4-35W MR16 827 36D	85 °C
929002494699	CorePro LED spot ND4.4-35W MR16 827 36DUK	85 °C
929002494702	CorePro LED spot ND 4.4-35W MR16 840 36D	85 °C
929002494799	CorePro LED spot ND4.4-35W MR16 840 36DUK	85 °C

Order Code	Full Product Name	T-Case maximum (nom.)
929001904802	CorePro LED spot ND 7-50W MR16 827 36D	85 °C
929001904902	CorePro LED spot ND 7-50W MR16 830 36D	85 °C
929001905002	CorePro LED spot ND 7-50W MR16 840 36D	85 °C
929002066402	CorePro LED spot 2.3-20W 827 MR11 36D	60 °C

Mechanical and Housing

Order Code	Full Product Name	Lamp Finish	Bulb shape
929002494602	CorePro LED spot ND 4.4-35W MR16 827 36D	Clear	MR16
929002494699	CorePro LED spot ND4.4-35W MR16 827 36DUK	-	MR16
929002494702	CorePro LED spot ND 4.4-35W MR16 840 36D	Clear	MR16
929002494799	CorePro LED spot ND4.4-35W MR16 840 36DUK	-	MR16

Order Code	Full Product Name	Lamp Finish	Bulb shape
929001904802	CorePro LED spot ND 7-50W MR16 827 36D	Clear	MR16
929001904902	CorePro LED spot ND 7-50W MR16 830 36D	Clear	MR16
929001905002	CorePro LED spot ND 7-50W MR16 840 36D	Clear	MR16
929002066402	CorePro LED spot 2.3-20W 827 MR11 36D	Clear	MR11

Approval and Application

Order Code	Full Product Name	Energy consumption kWh/1,000 hours
929002494602	CorePro LED spot ND 4.4-35W MR16 827 36D	5 kWh
929002494699	CorePro LED spot ND4.4-35W MR16 827 36DUK	5 kWh
929002494702	CorePro LED spot ND 4.4-35W MR16 840 36D	5 kWh
929002494799	CorePro LED spot ND4.4-35W MR16 840 36DUK	5 kWh
929001904802	CorePro LED spot ND 7-50W MR16 827 36D	7 kWh
929001904902	CorePro LED spot ND 7-50W MR16 830 36D	7 kWh
929001905002	CorePro LED spot ND 7-50W MR16 840 36D	7 kWh
929002066402	CorePro LED spot 2.3-20W 827 MR11 36D	3 kWh

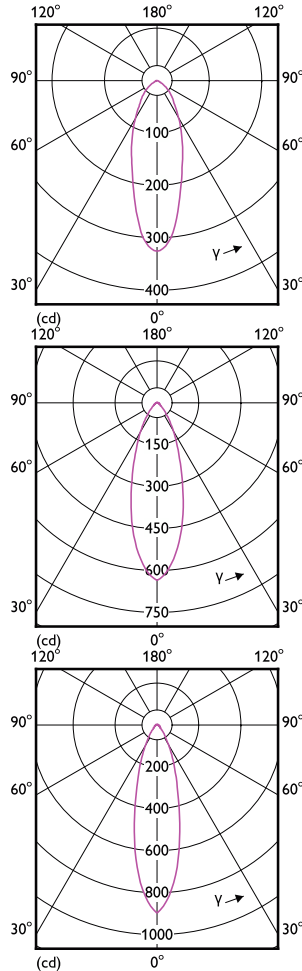
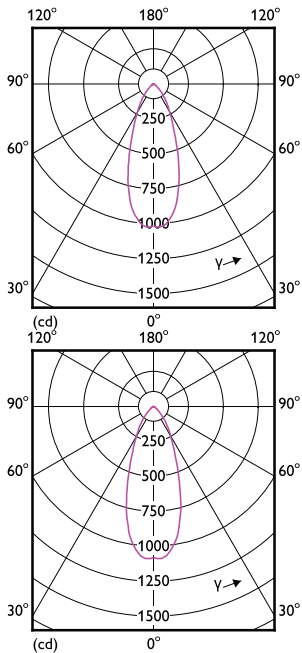

CorePro LED spot LV

Accent Diagrams

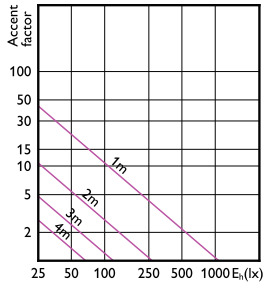

Accent Diagram - CorePro LED spot ND 7-50W MR16 840 36D

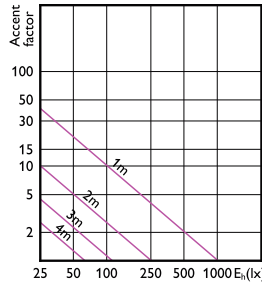

Accent Diagram - CorePro LED spot ND 7-50W MR16 827 36D

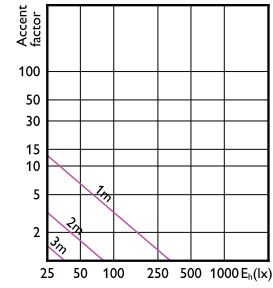

Accent Diagram - CorePro LED spot 2.3-20W 827 MR11 36D

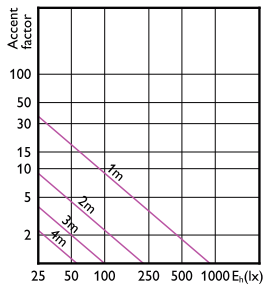

Accent Diagram - CorePro LED spot ND4.4-35W MR16 840 36DUK

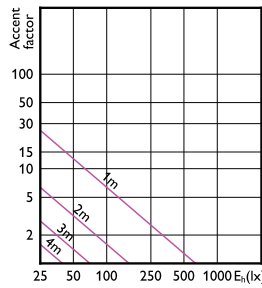

Accent Diagram - CorePro LED spot ND 4.4-35W MR16 827 36D

Beam Diagrams

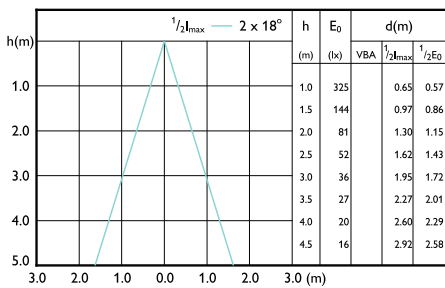

Beam diagram - CorePro LED spot 2.3-20W 827 MR11 36D

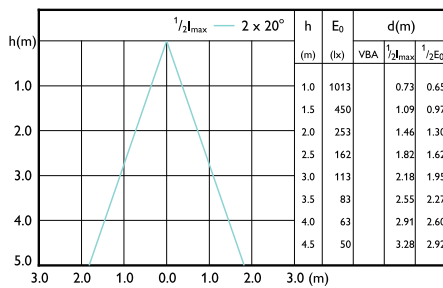

Beam diagram - CorePro LED spot ND 7-50W MR16 827 36D

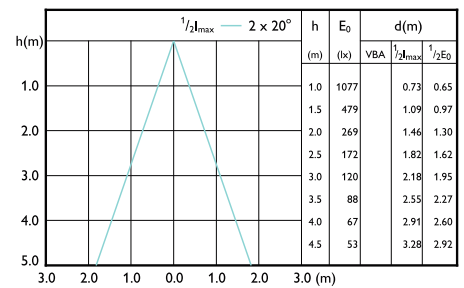

Beam diagram - CorePro LED spot ND 7-50W MR16 840 36D

Beam Diagrams

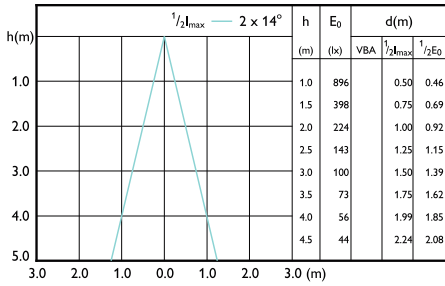

Beam diagram - CorePro LED spot ND4.4-35W MR16 840 36DUK

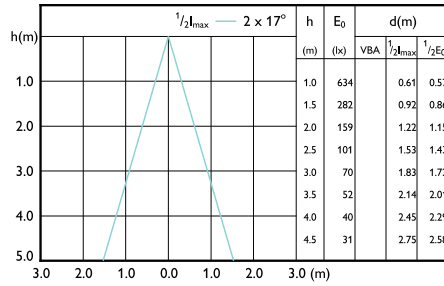

Beam diagram - CorePro LED spot ND 4.4-35W MR16 827 36D

