



# GreenPerform Highbay G5: a versatile LED highbay with optimized performance and future-proof control system

## GreenPerform Highbay G5

The GreenPerform Highbay G5 continues the GreenPerform family's enviable reputation for reliable performance. Not only does it deliver leading system efficacy and extended long-term quality, it also promises Unified Glare Rating (UGR) control with compact dimensions. GreenPerform Highbay G5 is also fully compatible with IoT software such as Interact, which is a scalable, future-proof control system. The family also has a series that supports cold room applications with 100% humidity and no condensation. All benefits that make this robust, optimized, and versatile family suitable for almost all industrial applications.

### Benefits

- Excellent energy savings
- Long-term quality and reliability
- Visual comfort
- Wide range of applications
- Connected ready for cloud-based IoT software applications

# GreenPerform Highbay G5

## Features

- 170 lm/W system efficacy
- 75,000 hours L70B50 lifetime @Ta 35°
- Glare control (Narrow Beam), uniform illuminance (Wide Beam)
- Works seamlessly with the Interact IoT software and platform
- Cold room application support

## Application

- Manufacturing
- Warehouses
- Logistic center
- Exhibition hall

## Specifications

<b>Mounting type</b>	Suspended
	Pipe
	Surface
<b>Operating Temperature range</b>	-30 to +50 °C
<b>Light Source</b>	LED
<b>Mains Voltage</b>	220-240V / 50-60Hz
<b>Mains connection</b>	Flying cable
<b>Mechanical Accessories</b>	Hook for suspension
	Mounting bracket for surface
<b>Dimming</b>	PSU: non-dimmable
	PSD: Dimmable via Dali-broadcasting
	Connected: Wireless control, compatible with SNH210 sensor
<b>Control system input</b>	DALI/Wireless
<b>Integrated sensors</b>	SNH210
<b>Material</b>	Housing: die-cast aluminium
<b>Main color of the luminaire</b>	RAL7012
<b>Flicker / Pst / SVM</b>	PSU: <30%
	PSD/Connected: <3.2%
<b>Luminous flux</b>	10klm-30klm
<b>Power consumption</b>	67W-205W

<b>Luminaire efficacy</b>	Up to 160lm/W
<b>Correlated color temperature - CCT</b>	4000K
<b>Color Rendering index - CRI</b>	6500K
<b>Color Rendering index - CRI</b>	80
<b>Beam angle</b>	WB: 85°
	NB: 55°
<b>Optical cover/lens material</b>	PC
<b>Optical cover/lens finish</b>	Clear
<b>Protection Class IEC61140</b>	Class I
<b>Mechanical impact protection</b>	IK08
<b>Ingress protection</b>	IP65
<b>Driver replaceable</b>	Yes
<b>UGR</b>	WB: 25
	NB: 22
<b>Installation</b>	Suspended
	Pipe
	Surface

## Versions



BY698X



BY698X

# GreenPerform Highbay G5

## Dimensional drawing

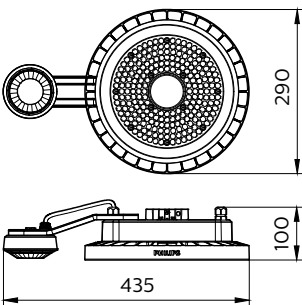
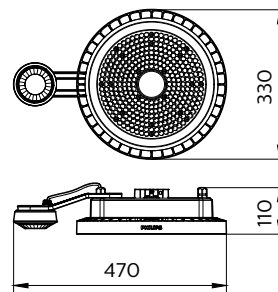
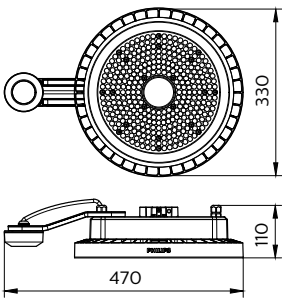
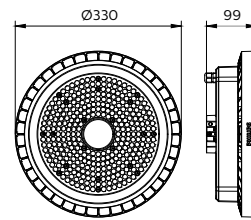
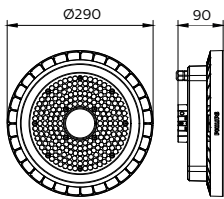
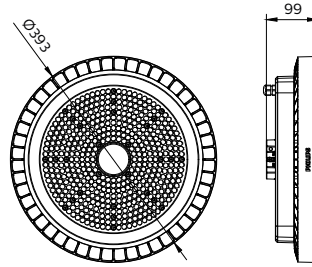
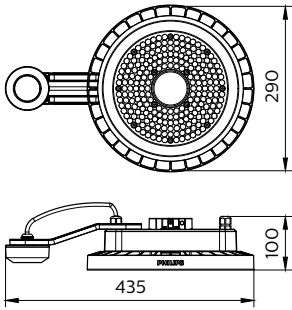

# GreenPerform Highbay G5

## Product details



GreenPerform Highbay G5

### General Information

Driver included	Yes
Gear	-
Number of gear units	1 unit

### Light Technical

Beam angle of light source	115 degree(s)
Correlated Color Temperature (Nom)	6500 K
Color rendering index (CRI)	80
Number of light sources	1
Optic type	Wide beam

### Operating and Electrical

Protection class IEC	Safety class I
Input Voltage	220 to 240 V
Line Frequency	50 or 60 Hz
Suitable for random switching	Yes

### Mechanical and Housing

Optical cover type	Clear dome
Housing Color	Grey
Ingress protection code	IP65

### Approval and Application

CE mark	Yes
ENEC mark	-
Flammability mark	For mounting on normally flammable surfaces

### Initial Performance (IEC Compliant)

Initial chromaticity	(0.317, 0.338) SDCM<5
----------------------	--------------------------

### Light Technical

Order Code	Full Product Name	Luminous Efficacy (rated) (Nom)	Luminous Flux
911401551045	BY698X G5 LED200/CW L1W PIR WB GM	169 lm/W	20,500 lm
911401552345	BY698X G5 LED150/CW L1W PIR WB GM L3m	170 lm/W	15,000 lm
911401528845	BY698P G5 LED150/CW PSU WB GM	170 lm/W	15,000 lm
911401529245	BY698P G5 LED200/CW PSU WB GM	169 lm/W	20,500 lm
911401529645	BY698P G5 LED250/CW PSU WB GM	173 lm/W	25,000 lm
911401530045	BY698P G5 LED300/CW PSU WB GM	171 lm/W	31,000 lm
911401547845	BY698X G5 LED150/CW L1W MW WB GM	170 lm/W	15,000 lm
911401548045	BY698X G5 LED200/CW L1W MW WB GM	169 lm/W	20,500 lm

## Operating and Electrical

Order Code	Full Product Name	Power Consumption
911401551045	BY698X G5 LED200/CW L1W PIR WB GM	121 W
911401552345	BY698X G5 LED150/CW L1W PIR WB GM L3m	88 W
911401528845	BY698P G5 LED150/CW PSU WB GM	88 W
911401529245	BY698P G5 LED200/CW PSU WB GM	121 W

Order Code	Full Product Name	Power Consumption
911401529645	BY698P G5 LED250/CW PSU WB GM	144 W
911401530045	BY698P G5 LED300/CW PSU WB GM	181 W
911401547845	BY698X G5 LED150/CW L1W MW WB GM	88 W
911401548045	BY698X G5 LED200/CW L1W MW WB GM	121 W

# GreenPerform Highbay G5

## Controls and Dimming

Order Code	Full Product Name	Dimmable	Maximum dim level
911401551045	BY698X G5 LED200/CW L1W PIR WB GM	Wireless Dim - Do not use with dimmer	0% (digital)
911401552345	BY698X G5 LED150/CW L1W PIR WB GM L3m	Wireless Dim - Do not use with dimmer	0% (digital)
911401528845	BY698P G5 LED150/CW PSU WB GM	-	Not applicable
911401529245	BY698P G5 LED200/CW PSU WB GM	-	Not applicable

Order Code	Full Product Name	Dimmable	Maximum dim level
911401529645	BY698P G5 LED250/CW PSU WB GM	-	Not applicable
911401530045	BY698P G5 LED300/CW PSU WB GM	-	Not applicable
911401547845	BY698X G5 LED150/CW L1W MW WB GM	Wireless Dim - Do not use with dimmer	0% (digital)
911401548045	BY698X G5 LED200/CW L1W MW WB GM	Wireless Dim - Do not use with dimmer	0% (digital)

## Mechanical and Housing

Order Code	Full Product Name	Mech. impact protection code
911401551045	BY698X G5 LED200/CW L1W PIR WB GM	IK03
911401552345	BY698X G5 LED150/CW L1W PIR WB GM L3m	IK03
911401528845	BY698P G5 LED150/CW PSU WB GM	IK08
911401529245	BY698P G5 LED200/CW PSU WB GM	IK08

Order Code	Full Product Name	Mech. impact protection code
911401529645	BY698P G5 LED250/CW PSU WB GM	IK08
911401530045	BY698P G5 LED300/CW PSU WB GM	IK08
911401547845	BY698X G5 LED150/CW L1W MW WB GM	IK06
911401548045	BY698X G5 LED200/CW L1W MW WB GM	IK06

## Approval and Application

Order Code	Full Product Name	Ambient temperature range	Glow-wire test
911401551045	BY698X G5 LED200/CW L1W PIR WB GM	-30 to +50 °C	Temperature 750 °C, duration 30 s
911401552345	BY698X G5 LED150/CW L1W PIR WB GM L3m	-30 to +50 °C	Temperature 750 °C, duration 30 s
911401528845	BY698P G5 LED150/CW PSU WB GM	-30 °C to 50 °C	Temperature 650 °C, duration 30 s
911401529245	BY698P G5 LED200/CW PSU WB GM	-30 °C to 50 °C	Temperature 650 °C, duration 30 s

Order Code	Full Product Name	Ambient temperature range	Glow-wire test
911401529645	BY698P G5 LED250/CW PSU WB GM	-30 °C to 50 °C	Temperature 650 °C, duration 30 s
911401530045	BY698P G5 LED300/CW PSU WB GM	-30 °C to 50 °C	Temperature 650 °C, duration 30 s
911401547845	BY698X G5 LED150/CW L1W MW WB GM	-30 to +50 °C	Temperature 750 °C, duration 30 s
911401548045	BY698X G5 LED200/CW L1W MW WB GM	-30 to +50 °C	Temperature 750 °C, duration 30 s

## Initial Performance (IEC Compliant)

Order Code	Full Product Name	Luminous flux tolerance
911401551045	BY698X G5 LED200/CW L1W PIR WB GM	+/-10%
911401552345	BY698X G5 LED150/CW L1W PIR WB GM L3m	+/-10%
911401528845	BY698P G5 LED150/CW PSU WB GM	-10% / +10%
911401529245	BY698P G5 LED200/CW PSU WB GM	-10% / +10%

Order Code	Full Product Name	Luminous flux tolerance
911401529645	BY698P G5 LED250/CW PSU WB GM	-10% / +10%
911401530045	BY698P G5 LED300/CW PSU WB GM	-10% / +10%
911401547845	BY698X G5 LED150/CW L1W MW WB GM	+/-10%
911401548045	BY698X G5 LED200/CW L1W MW WB GM	+/-10%

## GreenPerform Highbay G5

