

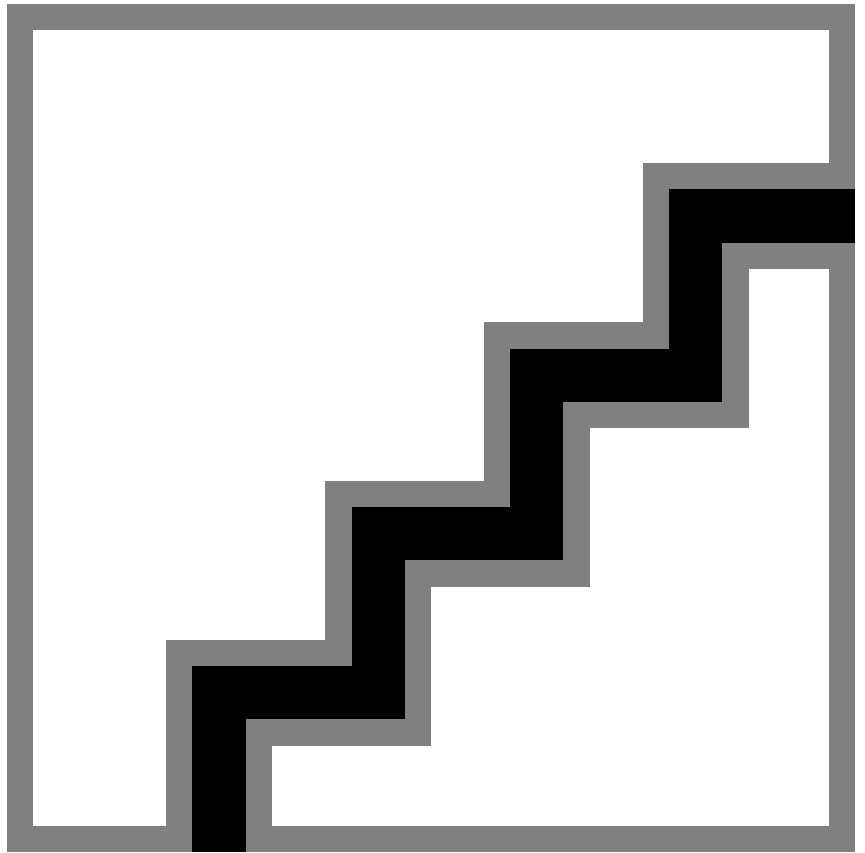

Clearflood gen2

BVP655



## Clearflood gen2: Your optimized TCO solution for general area and recreational sports projects

This new generation of Clearflood range brings the total cost of ownership of your project to the next level. The range comes in three sizes (BVP655, BVP656, BVP657/BVP658) with several finishing and serviceability options, and utilises the light engine of our Recreational Sports & Area flagship floodlight. This light engine is optimised for sports applications, as well as large areas, such as logistical hubs, outdoor car parks and storage areas. Now an innovative design approach allows the availability of connected options such as the SR socket, fully integrated on the floodlight housing, and a multi-sensor on the bracket. The product range is compatible with Interact systems.

## Benefits

- Optimized total cost of ownership thanks to a good balance between initial investment and operational costs
- Compatible with Interact systems
- Choose your serviceability level and finishing
- Long lasting, robust design

## Applications

- Arena and Sports
- Airports
- Manufacturing
- Warehouses
- Harbor

## Versions



Clearflood gen2 large -  
BVP657



Clearflood gen2 medium -  
BVP656



Clearflood gen2 small -  
BVP655

## Dimensional drawing

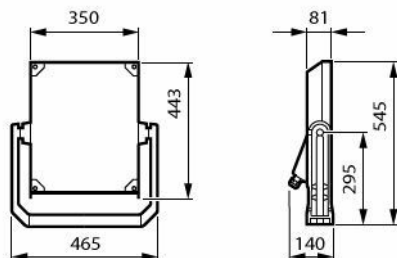

BVP655 LED300-4S/740 PSU DW10 ALU

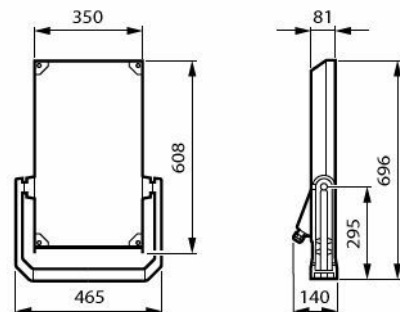

BVP656 LED600-4S/740 PSU DW10 ALU

## Features

- Features dedicated Sports&Area light engine and optics
- 3 different sizes: small (BVP655), medium (BVP656), large (BVP657 and BVP658)
- CCT available from 2700K to 5700K
- Electrical class I and II
- IP66, IK08
- Serviceability options: toolless opening or fixed glass
- Finishing options: raw, standard, marine protection (MSP), swimming pool protection (SPO)
- Connectivity options: SR socket, OLC node and multi-sensor options are available

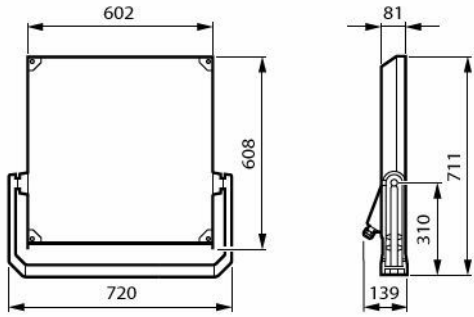

BVP657 LED930-4S/740 PSU A35-MB ALU

**Product details**

Opening without tool



Fixed glass



Combo SR node and OSB sensor



SR socket on bracket



SR node on housing



**General Information**

Driver included	Yes
Service Tag	Yes

## Light Technical

Upwards light output ratio	0
Correlated Colour Temperature (Nom)	4000 K
Colour rendering index (CRI)	70
Light source colour	740 neutral white
Optic type outdoor	Asymmetrical

## Operating and Electrical

Surge Protection (Common/Differential)	6/8 kV
--	--------

## Controls and Dimming

Dimmable	No
----------	----

## Mechanical and Housing

Housing Colour	Aluminium
Ingress protection code	IP66 [Dust penetration-protected, jet-proof]
Mech. impact protection code	IK08 [5 J vandal-protected]
Standard tilt angle post-top	-
Standard tilt angle side entry	-
Optical cover type	Clear glass

## Approval and Application

Flammability mark	-
CE mark	Yes

## General Information

Order Code	Full Product Name	Lamp family code	Number of gear units
912300060565	BVP657 LED930-4S/740 PSU A65-WB ALU	LED930	3 units
912300060566	BVP657 LED930-4S/740 PSU A55-MB ALU	LED930	3 units
912300060567	BVP657 LED930-4S/740 PSU A65-VWB ALU	LED930	3 units
912300060568	BVP657 LED930-4S/740 PSU A35-MB ALU	LED930	3 units
912300060569	BVP657 LED930-4S/740 PSU DW10 ALU	LED930	3 units
912300060570	BVP657 LED930-4S/740 PSU DW30 ALU	LED930	3 units
912300060571	BVP657 LED930-4S/740 PSU A65-NWB ALU	LED930	3 units
912300060558	BVP656 LED600-4S/740 PSU A65-WB ALU	LED600	2 units
912300060559	BVP656 LED600-4S/740 PSU A55-MB ALU	LED600	2 units

Order Code	Full Product Name	Lamp family code	Number of gear units
912300060560	BVP656 LED600-4S/740 PSU A65-VWB ALU	LED600	2 units
912300060561	BVP656 LED600-4S/740 PSU A35-MB ALU	LED600	2 units
912300060562	BVP656 LED600-4S/740 PSU DW10 ALU	LED600	2 units
912300060563	BVP656 LED600-4S/740 PSU DW30 ALU	LED600	2 units
912300060564	BVP656 LED600-4S/740 PSU A65-NWB ALU	LED600	2 units
912300060551	BVP655 LED300-4S/740 PSU A65-WB ALU	LED300	Unit
912300060552	BVP655 LED300-4S/740 PSU A55-MB ALU	LED300	Unit
912300060553	BVP655 LED300-4S/740 PSU A65-VWB ALU	LED300	Unit
912300060554	BVP655 LED300-4S/740 PSU A35-MB ALU	LED300	Unit
912300060555	BVP655 LED300-4S/740 PSU DW10 ALU	LED300	Unit
912300060556	BVP655 LED300-4S/740 PSU DW30 ALU	LED300	Unit
912300060557	BVP655 LED300-4S/740 PSU A65-WNB ALU	LED300	Unit

## Light Technical

Order Code	Full Product Name	Luminous Flux	Luminaire light beam spread
912300060565	BVP657 LED930-4S/740 PSU A65-WB ALU	70,450 lm	5° - 13° x 128°
912300060566	BVP657 LED930-4S/740 PSU A55-MB ALU	76,900 lm	5° - 17° x 97°
912300060567	BVP657 LED930-4S/740 PSU A65-VWB ALU	73,580 lm	5° - 16° x 149°
912300060568	BVP657 LED930-4S/740 PSU A35-MB ALU	78,980 lm	6° - 21° x 99°
912300060569	BVP657 LED930-4S/740 PSU DW10 ALU	78,539 lm	26° - 22° x 147°
912300060570	BVP657 LED930-4S/740 PSU DW30 ALU	78,863 lm	35° - 17° x 122°
912300060571	BVP657 LED930-4S/740 PSU A65-NWB ALU	71,680 lm	6° - 14° x 122°
912300060558	BVP656 LED600-4S/740 PSU A65-WB ALU	45,630 lm	5° - 13° x 128°
912300060559	BVP656 LED600-4S/740 PSU A55-MB ALU	49,810 lm	5° - 17° x 97°
912300060560	BVP656 LED600-4S/740 PSU A65-VWB ALU	47,660 lm	5° - 16° x 149°
912300060561	BVP656 LED600-4S/740 PSU A35-MB ALU	51,160 lm	6° - 21° x 99°
912300060562	BVP656 LED600-4S/740 PSU DW10 ALU	50,490 lm	26° - 22° x 147°
912300060563	BVP656 LED600-4S/740 PSU DW30 ALU	50,699 lm	35° - 17° x 122°
912300060564	BVP656 LED600-4S/740 PSU A65-NWB ALU	46,430 lm	6° - 14° x 122°
912300060551	BVP655 LED300-4S/740 PSU A65-WB ALU	23,100 lm	5° - 13° x 128°
912300060552	BVP655 LED300-4S/740 PSU A55-MB ALU	25,220 lm	5° - 17° x 97°
912300060553	BVP655 LED300-4S/740 PSU A65-VWB ALU	24,130 lm	5° - 16° x 149°
912300060554	BVP655 LED300-4S/740 PSU A35-MB ALU	25,900 lm	6° - 21° x 99°
912300060555	BVP655 LED300-4S/740 PSU DW10 ALU	25,488 lm	26° - 22° x 147°
912300060556	BVP655 LED300-4S/740 PSU DW30 ALU	25,431 lm	35° - 17° x 122°
912300060557	BVP655 LED300-4S/740 PSU A65-WNB ALU	23,510 lm	6° - 14° x 122°

## Operating and Electrical

Order Code	Full Product Name	Power Consumption
912300060565	BVP657 LED930-4S/740 PSU A65-WB ALU	530 W
912300060566	BVP657 LED930-4S/740 PSU A55-MB ALU	530 W
912300060567	BVP657 LED930-4S/740 PSU A65-VWB ALU	530 W
912300060568	BVP657 LED930-4S/740 PSU A35-MB ALU	530 W
912300060569	BVP657 LED930-4S/740 PSU DW10 ALU	530 W
912300060570	BVP657 LED930-4S/740 PSU DW30 ALU	530 W
912300060571	BVP657 LED930-4S/740 PSU A65-NWB ALU	530 W
912300060558	BVP656 LED600-4S/740 PSU A65-WB ALU	341 W
912300060559	BVP656 LED600-4S/740 PSU A55-MB ALU	341 W
912300060560	BVP656 LED600-4S/740 PSU A65-VWB ALU	341 W
912300060561	BVP656 LED600-4S/740 PSU A35-MB ALU	341 W
912300060562	BVP656 LED600-4S/740 PSU DW10 ALU	341 W
912300060563	BVP656 LED600-4S/740 PSU DW30 ALU	341 W
912300060564	BVP656 LED600-4S/740 PSU A65-NWB ALU	341 W
912300060551	BVP655 LED300-4S/740 PSU A65-WB ALU	172 W
912300060552	BVP655 LED300-4S/740 PSU A55-MB ALU	172 W
912300060553	BVP655 LED300-4S/740 PSU A65-VWB ALU	172 W
912300060554	BVP655 LED300-4S/740 PSU A35-MB ALU	172 W
912300060555	BVP655 LED300-4S/740 PSU DW10 ALU	172 W
912300060556	BVP655 LED300-4S/740 PSU DW30 ALU	172 W
912300060557	BVP655 LED300-4S/740 PSU A65-WNB ALU	172 W

## Product Data

Order Code	Full Product Name	Product family code
912300060565	BVP657 LED930-4S/740 PSU A65-WB ALU	BVP657
912300060566	BVP657 LED930-4S/740 PSU A55-MB ALU	BVP657
912300060567	BVP657 LED930-4S/740 PSU A65-VWB ALU	BVP657
912300060568	BVP657 LED930-4S/740 PSU A35-MB ALU	BVP657
912300060569	BVP657 LED930-4S/740 PSU DW10 ALU	BVP657
912300060570	BVP657 LED930-4S/740 PSU DW30 ALU	BVP657
912300060571	BVP657 LED930-4S/740 PSU A65-NWB ALU	BVP657
912300060558	BVP656 LED600-4S/740 PSU A65-WB ALU	BVP656
912300060559	BVP656 LED600-4S/740 PSU A55-MB ALU	BVP656
912300060560	BVP656 LED600-4S/740 PSU A65-VWB ALU	BVP656
912300060561	BVP656 LED600-4S/740 PSU A35-MB ALU	BVP656
912300060562	BVP656 LED600-4S/740 PSU DW10 ALU	BVP656
912300060563	BVP656 LED600-4S/740 PSU DW30 ALU	BVP656

Order Code	Full Product Name	Product family code
912300060564	BVP656 LED600-4S/740 PSU A65-NWB ALU	BVP656
912300060551	BVP655 LED300-4S/740 PSU A65-WB ALU	BVP655
912300060552	BVP655 LED300-4S/740 PSU A55-MB ALU	BVP655
912300060553	BVP655 LED300-4S/740 PSU A65-VWB ALU	BVP655
912300060554	BVP655 LED300-4S/740 PSU A35-MB ALU	BVP655
912300060555	BVP655 LED300-4S/740 PSU DW10 ALU	BVP655
912300060556	BVP655 LED300-4S/740 PSU DW30 ALU	BVP655
912300060557	BVP655 LED300-4S/740 PSU A65-WNB ALU	BVP655

## Polar normal diagrams

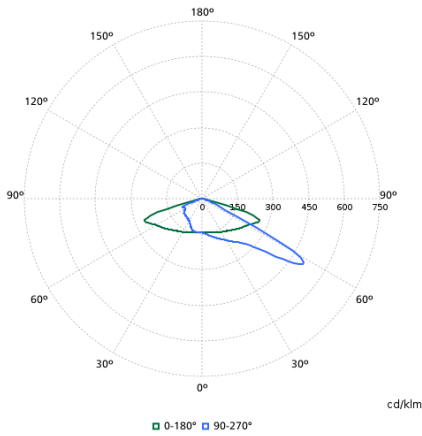

BVP656I - 912300060560

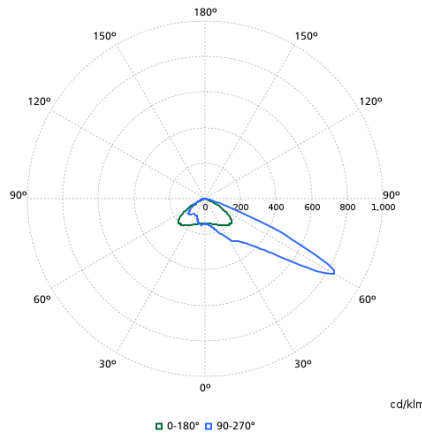

BVP656I - 912300060564

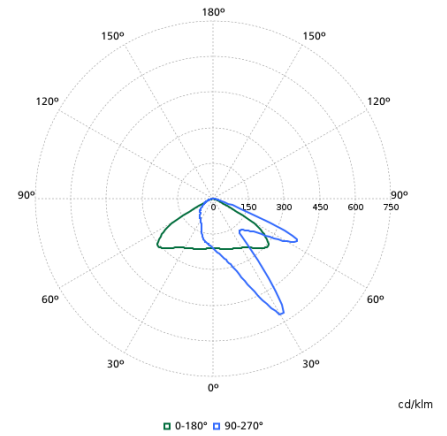

BVP655I - 912300060556

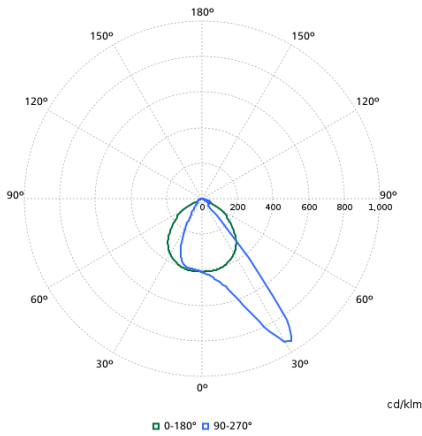

BVP656I - 912300060561

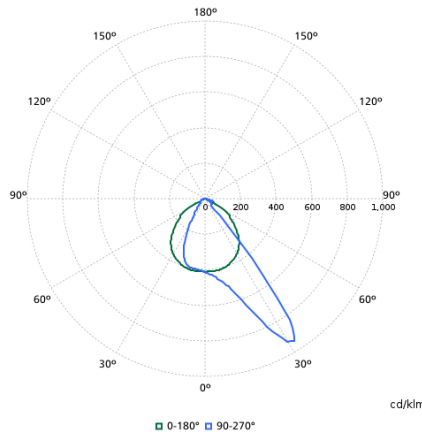

BVP655I - 912300060554

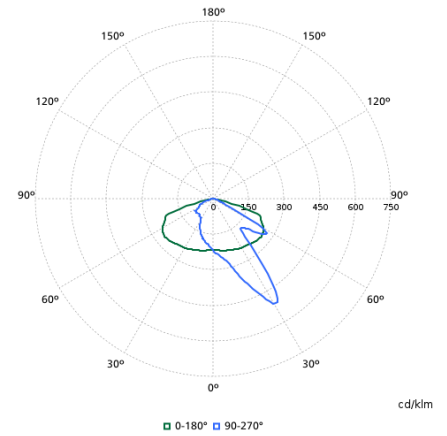

BVP655I - 912300060555

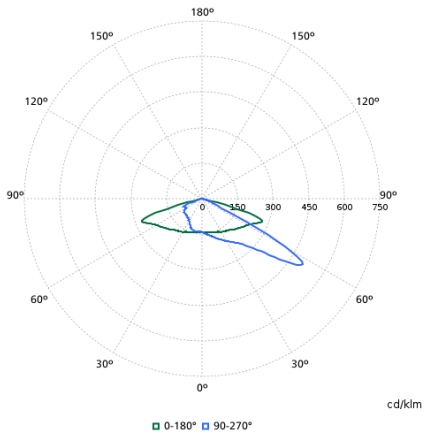

BVP655I - 912300060553

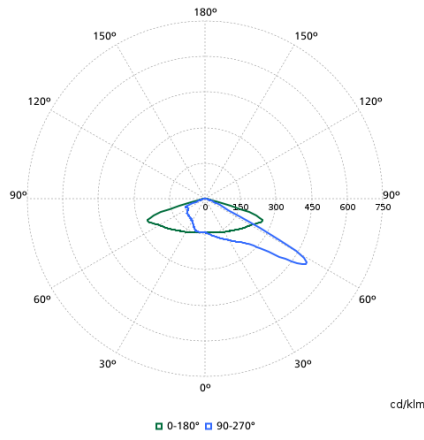

BVP657I - 912300060567

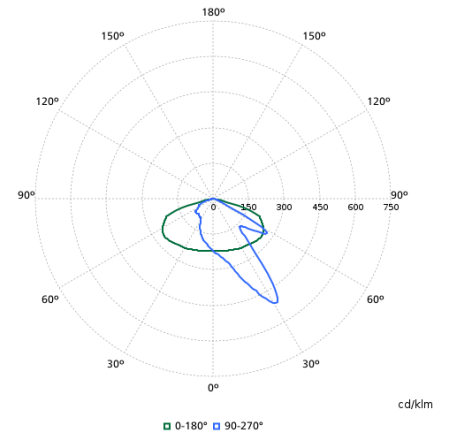

BVP657I - 912300060569

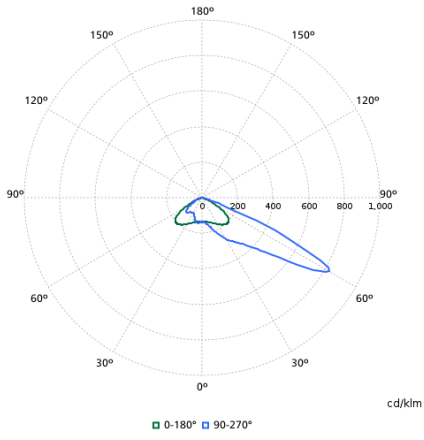

BVP655I - 912300060557

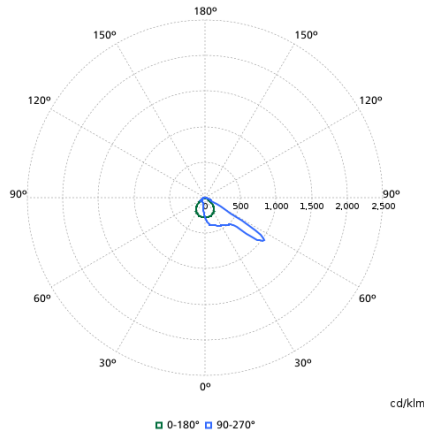

BVP657I - 912300060566

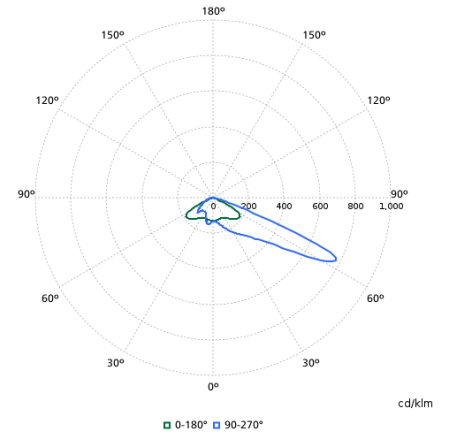

BVP655I - 912300060551

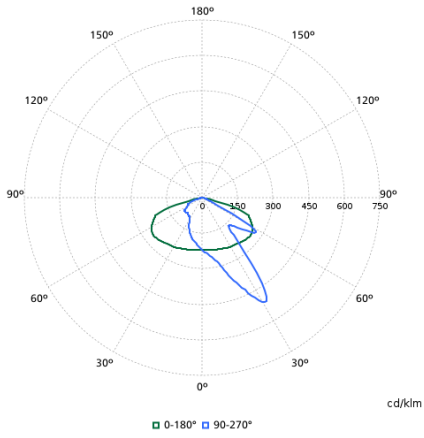

BVP656I - 912300060562

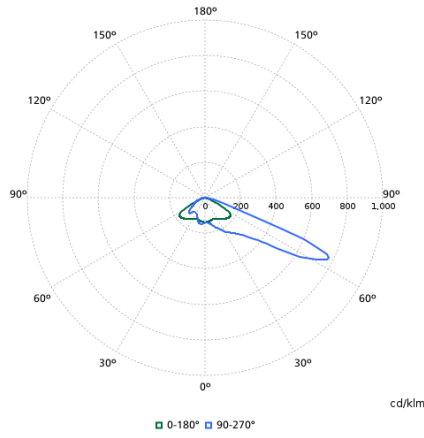

BVP656I - 912300060558

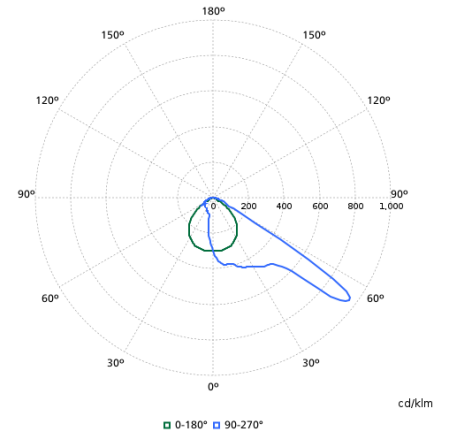

BVP655I - 912300060552

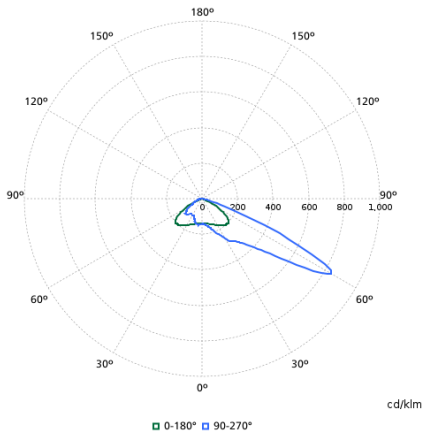

BVP657I - 912300060571

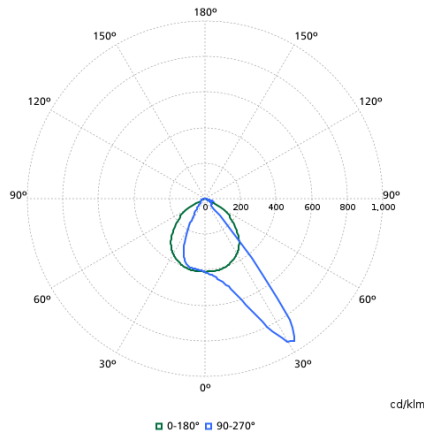

BVP657I - 912300060568

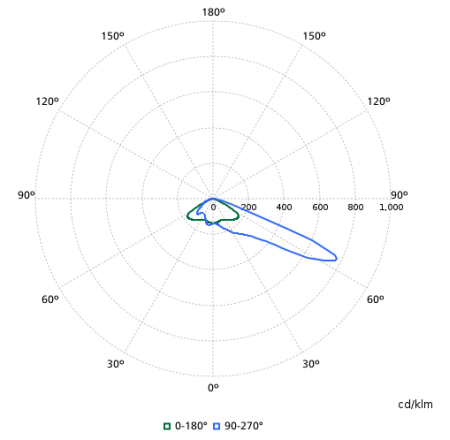

BVP657I - 912300060565

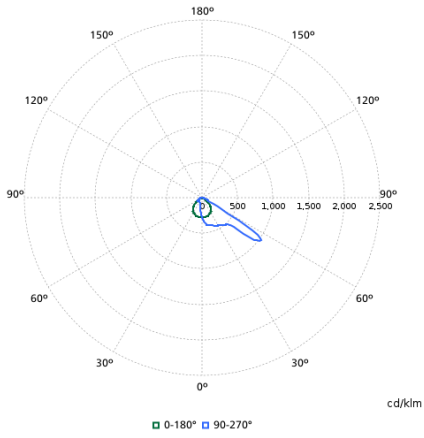

BVP656I - 912300060559

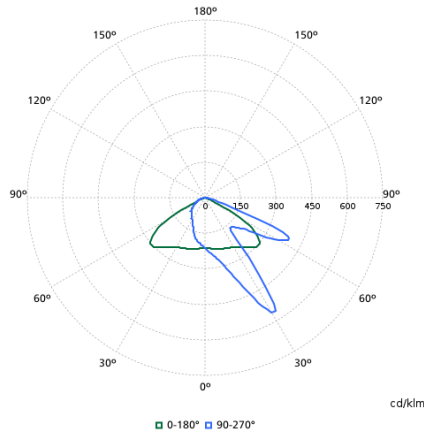

BVP656I - 912300060563

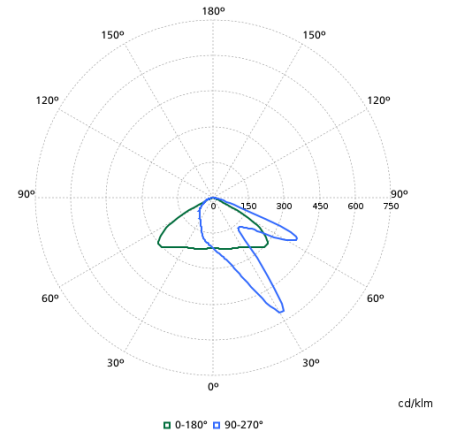

BVP657I - 912300060570