



Iconic design, ready to participate in your smart city ecosystem

CityMood draws its inspiration from the street lamps of the early 20th century, which combined a conical bowl with a suspended canopy. CityMood preserves your city heritage by keeping the distinctive design characteristics of these iconic luminaires. CityMood integrates smoothly into existing infrastructures, poles, and brackets, and reduces energy costs without sacrificing safety, performance, or quality of light. The LEDGINE - O comes as a standard feature, with light output ranging from 900 lm to 16200 lm, a choice of more than 30 optics and distributions, and a range of CCTs and CRIs. Designed for mounting heights of 4 m to 8 m, CityMood is ideal for a wide range of outdoor lighting applications in both contemporary and historical environments. Future-proof and ready to participate in smart city ecosystems, CityMood helps you make progress toward your sustainability goals, wherever you happen to be in your digitalization journey. CityMood is available with one or two Zhaga-D4i (ZD4i) system-

ready (SR) sockets and is therefore ready to pair with advanced lighting management systems such as Interact, or with sensors such as the Outdoor Sensor Bundle (OSB). Every CityMood luminaire is uniquely identifiable via the Signify Service tag app. Simply scan a QR code placed inside the mast door or directly on the luminaire to instantly access the luminaire configuration. Service tag makes maintenance and programming operations faster and easier, and enables you to create a digital library of lighting assets and spare parts. Toolless opening versions provide direct access to the gear and light engine.

Benefits

- Iconic and elegant luminaire preserves your city heritage in both contemporary and historical environments
- Future-proof and ready to participate in smart city ecosystems via a Zhaga-D4i (ZD4i) SR (system-ready) socket
- Toolless opening versions are easy to install and maintain
- Equipped with Service tag, a QR-based identification system that uniquely identifies each luminaire and provides maintenance, installation, and spare parts information

Applications

- Parks and Plazas
- Residential
- Road and Street

Versions



CityMood BSP672 with clear polycarbonate bowl and bottom crown



CityMood BSP672 with clear flat glass

- Main urban roads and streets, side and residential roads and streets
- City centers and historical areas
- Cycle and pedestrian paths, squares, parks, and playgrounds

Features

- Available with clear flat glass or clear polycarbonate bowl
- Optional decorative crowns
- Energy- and optically-efficient LED technology
- Large choice of beams angles
- Internal louver to minimize glare and obtrusive backlight
- Ready to pair with advanced control and lighting management systems such as Interact, or sensors such as the Outdoor Sensor Bundle (OSB)

Dimensional drawing

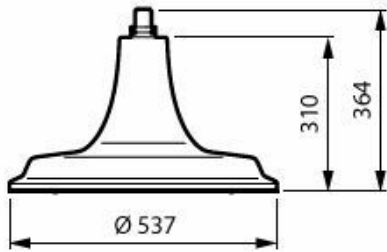
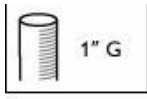

BSP672 LED80/730 FG II DM10 G1 BK

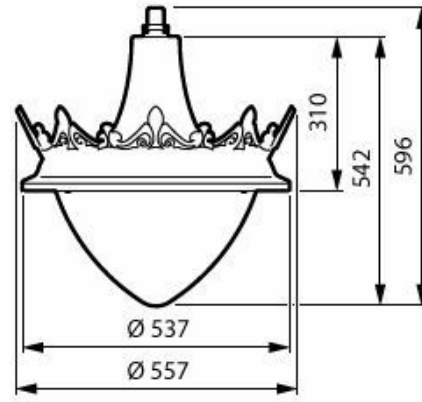

BSP672 LED20/730 PCC II DM50 G1 CRN2 AL

Product details



CityMood 1" gas suspended fixation with counter-nut



CityMood hinge view

General Information

Number of gear units	1 unit
Driver included	Yes
Service tag	Yes

Light Technical

Correlated Color Temperature (Nom)	3000 K
Color rendering index (CRI)	70
Light source color	730 warm white
Luminaire light beam spread	-

Operating and Electrical

Surge Protection (Common/Differential) Standard surge protection level

Controls and Dimming

Dimmable Yes
Maximum dim level Not applicable

Mechanical and Housing

Housing Color Black
Ingress protection code IP66 [Dust penetration-protected, jet-proof]
Standard tilt angle posttop -
Standard tilt angle side entry -

Emergency Operation

Central Emergency No

Approval and Application

Flammability mark -
CE mark Yes

Product Data

Product family code BSP672 [CityMood]

General Information

Order Code	Full Product Name	Lamp family code
56845700	BSP672 LED20/730 PCC II DM50 G1 CRN2 AL	LED20
56849500	BSP672 LED80/730 FG II DM10 G1 BK	LED80

Light Technical

Order Code	Full Product Name	Upward light output ratio	Luminous Flux	Optic type outdoor
56845700	BSP672 LED20/730 PCC II DM50 G1 CRN2 AL	2	1,840 lm	Distribution medium 50
56849500	BSP672 LED80/730 FG II DM10 G1 BK	0	7,200 lm	Distribution medium 10

Operating and Electrical

Order Code	Full Product Name	Power Consumption
56845700	BSP672 LED20/730 PCC II DM50 G1 CRN2 AL	13 W
56849500	BSP672 LED80/730 FG II DM10 G1 BK	46.2 W

Mechanical and Housing

Order Code	Full Product Name	Mech. impact protection code	Optical cover type
56845700	BSP672 LED20/730 PCC II DM50 G1 CRN2 AL	IK10	Polycarbonate bowl/cover clear
56849500	BSP672 LED80/730 FG II DM10 G1 BK	IK09	Flat glass

Polar normal diagrams

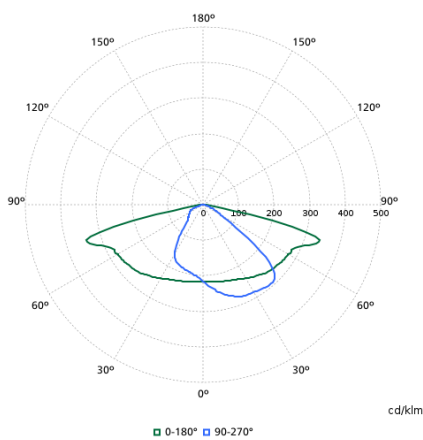

BSP672I - 912300060514

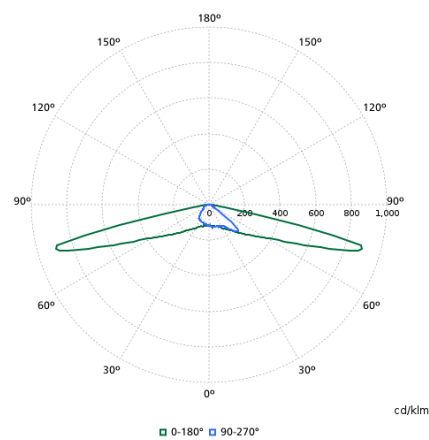

BSP672I - 912300060510