



# Iridium gen4 – Leading the way in road lighting comfort and convenience

## Iridium gen4

Iridium gen4, the fourth generation of the Iridium family, is completely redesigned and fully optimized for visual comfort and tool-less maintenance. The Iridium gen4 provides guidance through the clear curved bowl placed in each luminaire along the road. Optional is the offer with GentleBeam. This is a textured curved glass, which reduces glare and improves visual comfort, while maintaining a good lighting distribution. The luminaire holds a new plug and play GearFlex module. This ensures a simplified maintenance and spare part repair process. The complete redesigned luminaire has a tool less opening, similar to Luma gen2, containing all electrical components in an easy to handle and accessible box inside the housing. Besides, the cable feed-through has been redesigned and access to the gear components is easy thanks to top down tool-less access. Iridium gen4 offers all connectivity and dimming options available today. As System Ready luminaire, it can be paired with lighting management systems such as Interact City or existing and upcoming sensor innovations. Also, installation has become easier and faster, and thanks to Service tag, you have access to all relevant documentations onsite. As a company conscious about the impact of light on the environment and biodiversity, the Iridium gen4 is equipped with dedicated light recipes that help with maintaining the optimal ecosystems for bats or preserve a dark night sky. Iridium gen4 is a luminaire rated as best in class regarding efficiency and light performance, compared to other luminaires in the range, in a broad range of applications.

# Iridium gen4

## Benefits

- Ease of maintenance and fast repair enablement with tool less opening and GearFlex module. With Service tag immediate spare part identification.
- Road lighting guidance with clear bowl and supporting visual comfort with GentleBeam
- System ready with SR socket to connect with Interact City lighting management software and third party lighting management systems and sensors

## Features

- New curved bowls for guidance lighting or visual comfort
- High impact resistance, IK10
- Equipped with dedicated light recipes that help 1) maintaining the optimal ecosystems for bats 2) preserve a dark night sky and reduce light pollution
- Efficacy up to 155 lm/W
- Choice of 40+ different beams and option of different internal louvers

## Application

- Motorways, inter-urban main roads, boulevards and avenues, roundabouts, pedestrian crossings
- Residential streets, side streets, squares, parks, cycle and pedestrian paths, playgrounds
- Parking areas, industrial areas, petrol stations, rail yards, airports, harbors, waterways

## Dimensional drawing

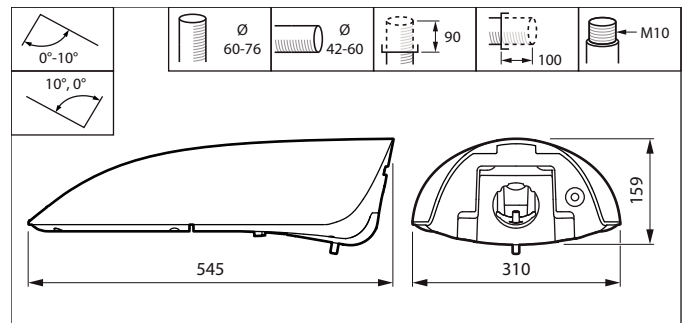
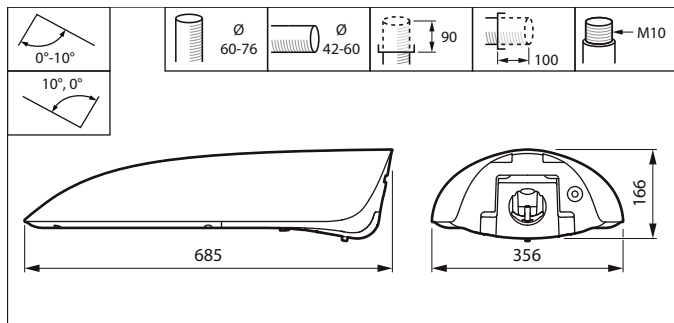
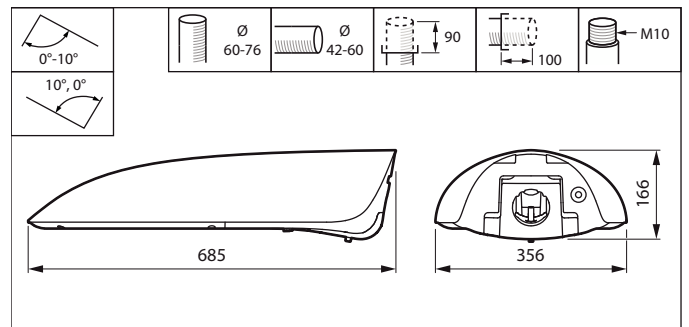
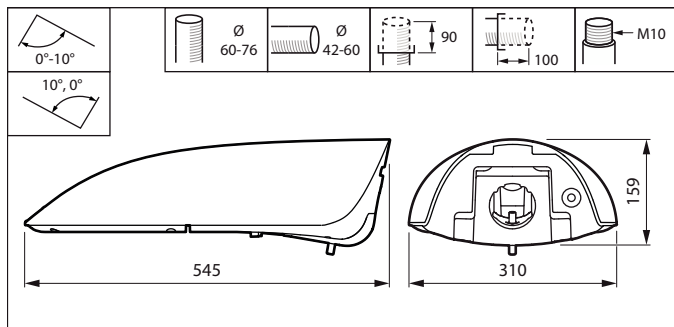

# Iridium gen4

## Product details

BGP501 Iridium gen4 Mini FG



BGP501 Iridium gen4 Mini Open2



BGP502 Iridium gen4 Medium Open2



BGP501 Iridium gen4 Mini Cable1



BGP502 Iridium gen4 Medium Open2



BGP502 Iridium gen4 Medium PCC GentleBeam



BGP501 Iridium gen4 Mini Open2



## General Information

Driver included	Yes
Light source replaceable	Yes
Number of gear units	1 unit
Service tag	Yes

## Light Technical

Upward light output ratio	0
---------------------------	---

## Operating and Electrical

Surge Protection (Common/Differential)	Surge protection level until 6 kV differential mode and 6 kV common mode
--	--

## Controls and Dimming

Maximum dim level	Not applicable
-------------------	----------------

## Mechanical and Housing

Mech. impact protection code	IK10
Ingress protection code	IP66
Standard tilt angle side entry	0°
Standard tilt angle posttop	0°

## Approval and Application

CE mark	Yes
Flammability mark	For mounting on normally flammable surfaces

## General Information

Order Code	Full Product Name	Gear	Lamp family code
910925866554	BGP501 LED10-4S/740 DM11 FG GF SRTB SP	-	LED10-4S
910925866555	BGP501 LED20-4S/740 DM11 FG GF SRTB S05Z	-	LED20-4S
910925866556	BGP501 LED27-4S/740 II DW10 FG GF SRTB S	-	LED27-4S
910925866557	BGP501 LED45-4S/740 II DW10 FG GF SRTB S	-	LED45-4S
910925866559	BGP501 LED10-4S/830 DW10 BL1 FG GF SRTB	-	LED10-4S
910925866560	BGP501 LED55-4S/740 II DM11 BL2 FG GF SR	-	LED55-4S
910925866561	BGP501 LED35-4S/740 DX10 FG GF D9 CLO H0	-	LED35-4S
910925866565	BGP501 LED18-4S/830 II DM10 PCC TXT GF	-	LED18-4S
910925867299	BGP502 LED75-4S/740 II GF DM32 MSP CLO	EBD	LED75-4S
910925867316	BGP502 LED45-4S/740 II GF DM31 GR MSP CO	EBD	LED45-4S
910925867317	BGP502 LED45-4S/830 II GF DM31 GR MSP CO	EBD	LED45-4S
910925867319	BGP502 LED80-4S/740 II GF DM11 GR CO CLO	EBD	LED80-4S
910925867321	BGP502 LED130-4S/740 II GF DM11 GR CO CL	EBD	LED130-4S
910925867323	BGP502 LED180-4S/740 II GF DM11 GR CO CL	EBD	LED180-4S
910925866567	BGP502 LED45-4S/740 DM11 FG GF SRTB S05Z	-	LED45-4S
910925866569	BGP502 LED110-4S/740 II DW10 FG GF SRTB	-	LED110-4S
910925866570	BGP502 LED100-4S/740 DM11 FG GF SRTB SP	-	LED100-4S
910925866571	BGP502 LED120-4S/830 DW10 BL1 FG GF SRTB	-	LED120-4S
910925866573	BGP502 LED160-4S/740 DX10 FG GF D9 CLO H	-	LED160-4S
910925866577	BGP502 LED130-4S/830 II DM10 PCC TXT GF	-	LED130-4S
910925867298	BGP501 LED45-4S/740 II GF DM32 MSP CLO	EBD	LED45-4S
910925867301	BGP501 LED16-4S/740 II GF DM11 GR CO CLO	EBD	LED16-4S
910925867304	BGP501 LED24-4S/740 II GF DM10 GR MSP CO	EBD	LED24-4S
910925867305	BGP501 LED24-4S/830 II GF DM10 GR MSP CO	EBD	LED24-4S
910925867306	BGP501 LED35-4S/740 II GF DM11 GR CO CLO	EBD	LED35-4S
910925867308	BGP501 LED40-4S/740 II GF DM11 GR CO CLO	EBD	LED40-4S
910925867310	BGP501 LED45-4S/740 II GF DM11 GR CO CLO	EBD	LED45-4S
910925867311	BGP501 LED45-4S/740 II GF DM11 GR CO CLO	EBD	LED45-4S
910925867312	BGP501 LED55-4S/740 II GF DM11 GR CO CLO	EBD	LED55-4S
910925867313	BGP501 LED50-4S/830 II GF DM11 GR CO CLO	EBD	LED50-4S
910925867314	BGP501 LED65-4S/740 II GF DM11 GR CO CLO	EBD	LED65-4S

## Light Technical (1/2)

Order Code	Full Product Name	Luminaire light beam spread	Light source color	Correlated Color Temperature (Nom)	Color rendering index (CRI)
910925866554	BGP501 LED10-4S/740 DM11 FG GF SRTB SP	45° x 54°	740 neutral white	4000 K	70
910925866555	BGP501 LED20-4S/740 DM11 FG GF SRTB S05Z	45° x 54°	740 neutral white	4000 K	70
910925866556	BGP501 LED27-4S/740 II DW10 FG GF SRTB S	34° x 62°	740 neutral white	4000 K	70

Order Code	Full Product Name	Luminaire light beam spread	Light source color	Correlated Color Temperature (Nom)	Color rendering index (CRI)
910925866557	BGP501 LED45-4S/740 II DW10 FG GF SRTB S	34° x 62°	740 neutral white	4000 K	70
910925866559	BGP501 LED10-4S/830 DW10 BL1 FG GF SRTB	13° x 60°	830 warm white	3000 K	80
910925866560	BGP501 LED55-4S/740 II DM11 BL2 FG GF SR	5° x 57°	740 neutral white	4000 K	70

# Iridium gen4

Order Code	Full Product Name	Luminaire light beam spread	Light source color	Correlated Color Temperature (Nom)	Color rendering index (CRI)
910925866561	BGP501 LED35-4S/740 DX10 FG GF D9 CLO H0	58° x 71°	740 neutral white	4000 K	70
910925866565	BGP501 LED18-4S/830 II DM10 PCC TXT GF	38° x 56°	830 warm white	3000 K	80
910925867299	BGP502 LED75-4S/740 II GF DM32 MSP CLO	16° x 47°	740 neutral white	4000 K	70
910925867316	BGP502 LED45-4S/740 II GF DM31 GR MSP CO	30° x 60°	740 neutral white	4000 K	70
910925867317	BGP502 LED45-4S/830 II GF DM31 GR MSP CO	30° x 60°	830 warm white	3000 K	80
910925867319	BGP502 LED80-4S/740 II GF DM11 GR CO CLO	45° x 54°	740 neutral white	4000 K	70
910925867321	BGP502 LED130-4S/740 II GF DM11 GR CO CL	45° x 54°	740 neutral white	4000 K	70
910925867323	BGP502 LED180-4S/740 II GF DM11 GR CO CL	45° x 54°	740 neutral white	4000 K	70
910925866567	BGP502 LED45-4S/740 DM11 FG GF SRTB S05Z	45° x 54°	740 neutral white	4000 K	70
910925866569	BGP502 LED110-4S/740 II DW10 FG GF SRTB	34° x 62°	740 neutral white	4000 K	70
910925866570	BGP502 LED100-4S/740 DM11 FG GF SRTB SP	45° x 54°	740 neutral white	4000 K	70
910925866571	BGP502 LED120-4S/830 DW10 BL1 FG GF SRTB	13° x 60°	830 warm white	3000 K	80
910925866573	BGP502 LED160-4S/740 DX10 FG GF D9 CLO H	58° x 71°	740 neutral white	4000 K	70

Order Code	Full Product Name	Luminaire light beam spread	Light source color	Correlated Color Temperature (Nom)	Color rendering index (CRI)
910925866577	BGP502 LED130-4S/830 II DM10 PCC TXT GF	38° x 56°	830 warm white	3000 K	80
910925867298	BGP501 LED45-4S/740 II GF DM32 MSP CLO	16° x 47°	740 neutral white	4000 K	70
910925867301	BGP501 LED16-4S/740 II GF DM11 GR CO CLO	45° x 54°	740 neutral white	4000 K	70
910925867304	BGP501 LED24-4S/740 II GF DM10 GR MSP CO	38° x 56°	740 neutral white	4000 K	70
910925867305	BGP501 LED24-4S/830 II GF DM10 GR MSP CO	38° x 56°	830 warm white	3000 K	80
910925867306	BGP501 LED35-4S/740 II GF DM11 GR CO CLO	45° x 54°	740 neutral white	4000 K	70
910925867308	BGP501 LED40-4S/740 II GF DM11 GR CO CLO	45° x 54°	740 neutral white	4000 K	70
910925867310	BGP501 LED45-4S/740 II GF DM11 GR CO CLO	45° x 54°	740 neutral white	4000 K	70
910925867311	BGP501 LED45-4S/740 II GF DM11 GR CO CLO	45° x 54°	830 warm white	3000 K	70
910925867312	BGP501 LED55-4S/740 II GF DM11 GR CO CLO	45° x 54°	740 neutral white	4000 K	70
910925867313	BGP501 LED50-4S/830 II GF DM11 GR CO CLO	45° x 54°	830 warm white	3000 K	80
910925867314	BGP501 LED65-4S/740 II GF DM11 GR CO CLO	45° x 54°	740 neutral white	4000 K	70

## Light Technical (2/2)

Order Code	Full Product Name	Luminous Flux	Optic type outdoor
910925866554	BGP501 LED10-4S/740 DM11 FG GF SRTB SP	900 lm	Distribution medium 11
910925866555	BGP501 LED20-4S/740 DM11 FG GF SRTB S05Z	1,780 lm	Distribution medium 11
910925866556	BGP501 LED27-4S/740 II DW10 FG GF SRTB S	2,430 lm	Distribution wide 10
910925866557	BGP501 LED45-4S/740 II DW10 FG GF SRTB S	3,960 lm	Distribution wide 10
910925866559	BGP501 LED10-4S/830 DW10 BL1 FG GF SRTB	910 lm	Distribution wide 10
910925866560	BGP501 LED55-4S/740 II DM11 BL2 FG GF SR	4,576 lm	Distribution medium 11
910925866561	BGP501 LED35-4S/740 DX10 FG GF D9 CLO HO	2,890 lm	Distribution extra wide 10
910925866565	BGP501 LED18-4S/830 II DM10 PCC TXT GF	1,584 lm	Distribution medium 10
910925867299	BGP502 LED75-4S/740 II GF DM32 MSP CLO	5,950 lm	Distribution medium 32
910925867316	BGP502 LED45-4S/740 II GF DM31 GR MSP CO	3,828 lm	Distribution medium 31
910925867317	BGP502 LED45-4S/830 II GF DM31 GR MSP CO	3,698 lm	Distribution medium 31
910925867319	BGP502 LED80-4S/740 II GF DM11 GR CO CLO	6,612 lm	Distribution medium 11
910925867321	BGP502 LED130-4S/740 II GF DM11 GR CO CL	10,625 lm	Distribution medium 11
910925867323	BGP502 LED180-4S/740 II GF DM11 GR CO CL	13,940 lm	Distribution medium 11
910925866567	BGP502 LED45-4S/740 DM11 FG GF SRTB S05Z	4,050 lm	Distribution medium 11
910925866569	BGP502 LED110-4S/740 II DW10 FG GF SRTB	9,570 lm	Distribution wide 10

Order Code	Full Product Name	Luminous Flux	Optic type outdoor
910925866570	BGP502 LED100-4S/740 DM11 FG GF SRTB SP	8,600 lm	Distribution medium 11
910925866571	BGP502 LED120-4S/830 DW10 BL1 FG GF SRTB	9,890 lm	Distribution wide 10
910925866573	BGP502 LED160-4S/740 DX10 FG GF D9 CLO H	12,245 lm	Distribution extra wide 10
910925866577	BGP502 LED130-4S/830 II DM10 PCC TXT GF	10,920 lm	Distribution medium 10
910925867298	BGP501 LED45-4S/740 II GF DM32 MSP CLO	3,698 lm	Distribution medium 32
910925867301	BGP501 LED16-4S/740 II GF DM11 GR CO CLO	1,395 lm	Distribution medium 11
910925867304	BGP501 LED24-4S/740 II GF DM10 GR MSP CO	2,136 lm	Distribution medium 10
910925867305	BGP501 LED24-4S/830 II GF DM10 GR MSP CO	2,160 lm	Distribution medium 10
910925867306	BGP501 LED35-4S/740 II GF DM11 GR CO CLO	3,026 lm	Distribution medium 11
910925867308	BGP501 LED40-4S/740 II GF DM11 GR CO CLO	3,471 lm	Distribution medium 11
910925867310	BGP501 LED45-4S/740 II GF DM11 GR CO CLO	3,784 lm	Distribution medium 11
910925867311	BGP501 LED45-4S/740 II GF DM11 GR CO CLO	3,784 lm	Distribution medium 11
910925867312	BGP501 LED55-4S/740 II GF DM11 GR CO CLO	4,524 lm	Distribution medium 11
910925867313	BGP501 LED50-4S/830 II GF DM11 GR CO CLO	4,042 lm	Distribution medium 11
910925867314	BGP501 LED65-4S/740 II GF DM11 GR CO CLO	5,332 lm	Distribution medium 11

## Operating and Electrical

Order Code	Full Product Name	Power Consumption
910925866554	BGP501 LED10-4S/740 DM11 FG GF SRTB SP	7.3 W
910925866555	BGP501 LED20-4S/740 DM11 FG GF SRTB S05Z	13.2 W
910925866556	BGP501 LED27-4S/740 II DW10 FG GF SRTB S	16.8 W
910925866557	BGP501 LED45-4S/740 II DW10 FG GF SRTB S	27.5 W
910925866559	BGP501 LED10-4S/830 DW10 BL1 FG GF SRTB	8.9 W
910925866560	BGP501 LED55-4S/740 II DM11 BL2 FG GF SR	34 W
910925866561	BGP501 LED35-4S/740 DX10 FG GF D9 CLO HO	21 W
910925866565	BGP501 LED18-4S/830 II DM10 PCC TXT GF	14.8 W
910925867299	BGP502 LED75-4S/740 II GF DM32 MSP CLO	51 W
910925867316	BGP502 LED45-4S/740 II GF DM31 GR MSP CO	28 W
910925867317	BGP502 LED45-4S/830 II GF DM31 GR MSP CO	36 W
910925867319	BGP502 LED80-4S/740 II GF DM11 GR CO CLO	46 W
910925867321	BGP502 LED130-4S/740 II GF DM11 GR CO CL	75 W
910925867323	BGP502 LED180-4S/740 II GF DM11 GR CO CL	106 W

Order Code	Full Product Name	Power Consumption
910925866567	BGP502 LED45-4S/740 DM11 FG GF SRTB S05Z	28 W
910925866569	BGP502 LED110-4S/740 II DW10 FG GF SRTB	63 W
910925866570	BGP502 LED100-4S/740 DM11 FG GF SRTB SP	57 W
910925866571	BGP502 LED120-4S/830 DW10 BL1 FG GF SRTB	79 W
910925866573	BGP502 LED160-4S/740 DX10 FG GF D9 CLO H	90 W
910925866577	BGP502 LED130-4S/830 II DM10 PCC TXT GF	98 W
910925867298	BGP501 LED45-4S/740 II GF DM32 MSP CLO	26.5 W
910925867301	BGP501 LED16-4S/740 II GF DM11 GR CO CLO	10.6 W
910925867304	BGP501 LED24-4S/740 II GF DM10 GR MSP CO	15 W
910925867305	BGP501 LED24-4S/830 II GF DM10 GR MSP CO	17 W
910925867306	BGP501 LED35-4S/740 II GF DM11 GR CO CLO	21 W
910925867308	BGP501 LED40-4S/740 II GF DM11 GR CO CLO	24 W
910925867310	BGP501 LED45-4S/740 II GF DM11 GR CO CLO	26.5 W
910925867311	BGP501 LED45-4S/740 II GF DM11 GR CO CLO	26.5 W

# Iridium gen4

Order Code	Full Product Name	Power Consumption
910925867312	BGP501 LED55-4S/740 II GF DM11 GR CO CLO	32.5 W
910925867313	BGP501 LED50-4S/830 II GF DM11 GR CO CLO	37.5 W

Order Code	Full Product Name	Power Consumption
910925867314	BGP501 LED65-4S/740 II GF DM11 GR CO CLO	39.5 W

## Controls and Dimming

Order Code	Full Product Name	Dimmable
910925866554	BGP501 LED10-4S/740 DM11 FG GF SRTB SP	No
910925866555	BGP501 LED20-4S/740 DM11 FG GF SRTB S05Z	No
910925866556	BGP501 LED27-4S/740 II DW10 FG GF SRTB S	No
910925866557	BGP501 LED45-4S/740 II DW10 FG GF SRTB S	No
910925866559	BGP501 LED10-4S/830 DW10 BL1 FG GF SRTB	No
910925866560	BGP501 LED55-4S/740 II DM11 BL2 FG GF SR	No
910925866561	BGP501 LED35-4S/740 DX10 FG GF D9 CLO H0	No
910925866565	BGP501 LED18-4S/830 II DM10 PCC TXT GF	Yes
910925867299	BGP502 LED75-4S/740 II GF DM32 MSP CLO	Yes
910925867316	BGP502 LED45-4S/740 II GF DM31 GR MSP CO	Yes
910925867317	BGP502 LED45-4S/830 II GF DM31 GR MSP CO	Yes
910925867319	BGP502 LED80-4S/740 II GF DM11 GR CO CLO	Yes
910925867321	BGP502 LED130-4S/740 II GF DM11 GR CO CL	Yes
910925867323	BGP502 LED180-4S/740 II GF DM11 GR CO CL	Yes
910925866567	BGP502 LED45-4S/740 DM11 FG GF SRTB S05Z	No
910925866569	BGP502 LED110-4S/740 II DW10 FG GF SRTB	No

Order Code	Full Product Name	Dimmable
910925866570	BGP502 LED100-4S/740 DM11 FG GF SRTB SP	No
910925866571	BGP502 LED120-4S/830 DW10 BL1 FG GF SRTB	No
910925866573	BGP502 LED160-4S/740 DX10 FG GF D9 CLO H	No
910925866577	BGP502 LED130-4S/830 II DM10 PCC TXT GF	No
910925867298	BGP501 LED45-4S/740 II GF DM32 MSP CLO	Yes
910925867301	BGP501 LED16-4S/740 II GF DM11 GR CO CLO	Yes
910925867304	BGP501 LED24-4S/740 II GF DM10 GR MSP CO	Yes
910925867305	BGP501 LED24-4S/830 II GF DM10 GR MSP CO	Yes
910925867306	BGP501 LED35-4S/740 II GF DM11 GR CO CLO	Yes
910925867308	BGP501 LED40-4S/740 II GF DM11 GR CO CLO	Yes
910925867310	BGP501 LED45-4S/740 II GF DM11 GR CO CLO	Yes
910925867311	BGP501 LED45-4S/740 II GF DM11 GR CO CLO	Yes
910925867312	BGP501 LED55-4S/740 II GF DM11 GR CO CLO	Yes
910925867313	BGP501 LED50-4S/830 II GF DM11 GR CO CLO	Yes
910925867314	BGP501 LED65-4S/740 II GF DM11 GR CO CLO	Yes

## Mechanical and Housing

Order Code	Full Product Name	Optical cover type	Housing Color
910925866554	BGP501 LED10-4S/740 DM11 FG GF SRTB SP	Glass	Gray
910925866555	BGP501 LED20-4S/740 DM11 FG GF SRTB S05Z	Glass	Gray
910925866556	BGP501 LED27-4S/740 II DW10 FG GF SRTB S	Glass	Gray
910925866557	BGP501 LED45-4S/740 II DW10 FG GF SRTB S	Glass	Gray
910925866559	BGP501 LED10-4S/830 DW10 BL1 FG GF SRTB	Glass	Gray
910925866560	BGP501 LED55-4S/740 II DM11 BL2 FG GF SR	Glass	Gray
910925866561	BGP501 LED35-4S/740 DX10 FG GF D9 CLO H0	Glass	Gray
910925866565	BGP501 LED18-4S/830 II DM10 PCC TXT GF	Polycarbonate	Gray
910925867299	BGP502 LED75-4S/740 II GF DM32 MSP CLO	Glass	Grey
910925867316	BGP502 LED45-4S/740 II GF DM31 GR MSP CO	Glass	Gray
910925867317	BGP502 LED45-4S/830 II GF DM31 GR MSP CO	Glass	Gray
910925867319	BGP502 LED80-4S/740 II GF DM11 GR CO CLO	Glass	Gray

Order Code	Full Product Name	Optical cover type	Housing Color
910925867321	BGP502 LED130-4S/740 II GF DM11 GR CO CL	Glass	Gray
910925867323	BGP502 LED180-4S/740 II GF DM11 GR CO CL	Glass	Gray
910925866567	BGP502 LED45-4S/740 DM11 FG GF SRTB S05Z	Glass	Gray
910925866569	BGP502 LED110-4S/740 II DW10 FG GF SRTB	Glass	Gray
910925866570	BGP502 LED100-4S/740 DM11 FG GF SRTB SP	Glass	Gray
910925866571	BGP502 LED120-4S/830 DW10 BL1 FG GF SRTB	Glass	Gray
910925866573	BGP502 LED160-4S/740 DX10 FG GF D9 CLO H	Glass	Gray
910925866577	BGP502 LED130-4S/830 II DM10 PCC TXT GF	Polycarbonate	Gray
910925867298	BGP501 LED45-4S/740 II GF DM32 MSP CLO	Glass	Gray
910925867301	BGP501 LED16-4S/740 II GF DM11 GR CO CLO	Glass	Gray
910925867304	BGP501 LED24-4S/740 II GF DM10 GR MSP CO	Glass	Gray
910925867305	BGP501 LED24-4S/830 II GF DM10 GR MSP CO	Glass	Gray

# Iridium gen4

Order Code	Full Product Name	Optical cover type	Housing Color
910925867306	BGP501 LED35-4S/740 II GF DM11 GR CO CLO	Glass	Gray
910925867308	BGP501 LED40-4S/740 II GF DM11 GR CO CLO	Glass	Gray
910925867310	BGP501 LED45-4S/740 II GF DM11 GR CO CLO	Glass	Gray
910925867311	BGP501 LED45-4S/740 II GF DM11 GR CO CLO	Glass	Gray

Order Code	Full Product Name	Optical cover type	Housing Color
910925867312	BGP501 LED55-4S/740 II GF DM11 GR CO CLO	Glass	Gray
910925867313	BGP501 LED50-4S/830 II GF DM11 GR CO CLO	Glass	Gray
910925867314	BGP501 LED65-4S/740 II GF DM11 GR CO CLO	Glass	Gray

## Over Time Performance (IEC Compliant)

Order Code	Full Product Name	Driver failure rate at 5000 h
910925866554	BGP501 LED10-4S/740 DM11 FG GF SRTB SP	0.5 %
910925866555	BGP501 LED20-4S/740 DM11 FG GF SRTB S05Z	0.5 %
910925866556	BGP501 LED27-4S/740 II DW10 FG GF SRTB S	0.5 %
910925866557	BGP501 LED45-4S/740 II DW10 FG GF SRTB S	0.5 %
910925866559	BGP501 LED10-4S/830 DW10 BL1 FG GF SRTB	0.5 %
910925866560	BGP501 LED55-4S/740 II DM11 BL2 FG GF SR	0.5 %
910925866561	BGP501 LED35-4S/740 DX10 FG GF D9 CLO HO	0.5 %
910925866565	BGP501 LED18-4S/830 II DM10 PCC TXT GF	0.5 %
910925867299	BGP502 LED75-4S/740 II GF DM32 MSP CLO	-
910925867316	BGP502 LED45-4S/740 II GF DM31 GR MSP CO	-
910925867317	BGP502 LED45-4S/830 II GF DM31 GR MSP CO	-
910925867319	BGP502 LED80-4S/740 II GF DM11 GR CO CLO	-
910925867321	BGP502 LED130-4S/740 II GF DM11 GR CO CL	-
910925867323	BGP502 LED180-4S/740 II GF DM11 GR CO CL	-
910925866567	BGP502 LED45-4S/740 DM11 FG GF SRTB S05Z	0.5 %
910925866569	BGP502 LED110-4S/740 II DW10 FG GF SRTB	0.5 %

Order Code	Full Product Name	Driver failure rate at 5000 h
910925866570	BGP502 LED100-4S/740 DM11 FG GF SRTB SP	0.5 %
910925866571	BGP502 LED120-4S/830 DW10 BL1 FG GF SRTB	0.5 %
910925866573	BGP502 LED160-4S/740 DX10 FG GF D9 CLO H	0.5 %
910925866577	BGP502 LED130-4S/830 II DM10 PCC TXT GF	0.5 %
910925867298	BGP501 LED45-4S/740 II GF DM32 MSP CLO	-
910925867301	BGP501 LED16-4S/740 II GF DM11 GR CO CLO	-
910925867304	BGP501 LED24-4S/740 II GF DM10 GR MSP CO	-
910925867305	BGP501 LED24-4S/830 II GF DM10 GR MSP CO	-
910925867306	BGP501 LED35-4S/740 II GF DM11 GR CO CLO	-
910925867308	BGP501 LED40-4S/740 II GF DM11 GR CO CLO	-
910925867310	BGP501 LED45-4S/740 II GF DM11 GR CO CLO	-
910925867311	BGP501 LED45-4S/740 II GF DM11 GR CO CLO	-
910925867312	BGP501 LED55-4S/740 II GF DM11 GR CO CLO	-
910925867313	BGP501 LED50-4S/830 II GF DM11 GR CO CLO	-
910925867314	BGP501 LED65-4S/740 II GF DM11 GR CO CLO	-

## Product Data

Order Code	Full Product Name	Product family code
910925866554	BGP501 LED10-4S/740 DM11 FG GF SRTB SP	BGP501
910925866555	BGP501 LED20-4S/740 DM11 FG GF SRTB S05Z	BGP501
910925866556	BGP501 LED27-4S/740 II DW10 FG GF SRTB S	BGP501
910925866557	BGP501 LED45-4S/740 II DW10 FG GF SRTB S	BGP501
910925866559	BGP501 LED10-4S/830 DW10 BL1 FG GF SRTB	BGP501
910925866560	BGP501 LED55-4S/740 II DM11 BL2 FG GF SR	BGP501
910925866561	BGP501 LED35-4S/740 DX10 FG GF D9 CLO HO	BGP501
910925866565	BGP501 LED18-4S/830 II DM10 PCC TXT GF	BGP501
910925867299	BGP502 LED75-4S/740 II GF DM32 MSP CLO	BGP502
910925867316	BGP502 LED45-4S/740 II GF DM31 GR MSP CO	BGP502
910925867317	BGP502 LED45-4S/830 II GF DM31 GR MSP CO	BGP502
910925867319	BGP502 LED80-4S/740 II GF DM11 GR CO CLO	BGP502
910925867321	BGP502 LED130-4S/740 II GF DM11 GR CO CL	BGP502
910925867323	BGP502 LED180-4S/740 II GF DM11 GR CO CL	BGP502
910925866567	BGP502 LED45-4S/740 DM11 FG GF SRTB S05Z	BGP502
910925866569	BGP502 LED110-4S/740 II DW10 FG GF SRTB	BGP502

Order Code	Full Product Name	Product family code
910925866570	BGP502 LED100-4S/740 DM11 FG GF SRTB SP	BGP502
910925866571	BGP502 LED120-4S/830 DW10 BL1 FG GF SRTB	BGP502
910925866573	BGP502 LED160-4S/740 DX10 FG GF D9 CLO H	BGP502
910925866577	BGP502 LED130-4S/830 II DM10 PCC TXT GF	BGP502
910925867298	BGP501 LED45-4S/740 II GF DM32 MSP CLO	BGP501
910925867301	BGP501 LED16-4S/740 II GF DM11 GR CO CLO	BGP501
910925867304	BGP501 LED24-4S/740 II GF DM10 GR MSP CO	BGP501
910925867305	BGP501 LED24-4S/830 II GF DM10 GR MSP CO	BGP501
910925867306	BGP501 LED35-4S/740 II GF DM11 GR CO CLO	BGP501
910925867308	BGP501 LED40-4S/740 II GF DM11 GR CO CLO	BGP501
910925867310	BGP501 LED45-4S/740 II GF DM11 GR CO CLO	BGP501
910925867311	BGP501 LED45-4S/740 II GF DM11 GR CO CLO	BGP501
910925867312	BGP501 LED55-4S/740 II GF DM11 GR CO CLO	BGP501
910925867313	BGP501 LED50-4S/830 II GF DM11 GR CO CLO	BGP501
910925867314	BGP501 LED65-4S/740 II GF DM11 GR CO CLO	BGP501

Polar Wide Diagrams

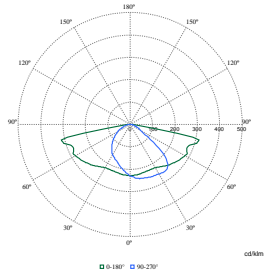

Polar Normal (separate) - BGP5011 - 910925866555

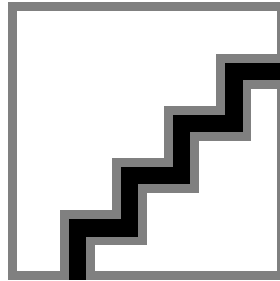

Polar Normal (separate) - BGP5021 - 910925866573

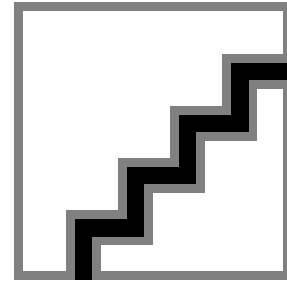

Polar Normal (separate) - BGP5011 - 910925866564

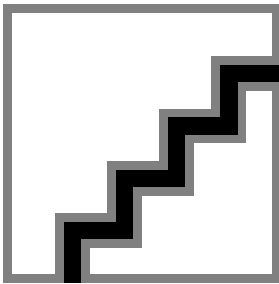

Polar Normal (separate) - BGP5011 - 910925866562

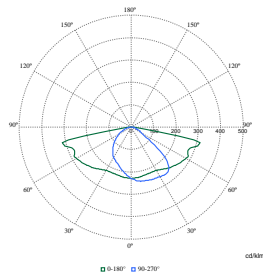

Polar Normal (separate) - BGP5021 - 910925866567

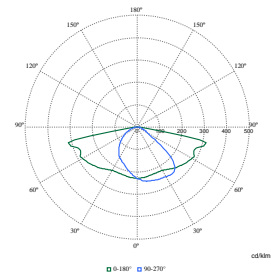

Polar Normal (separate) - BGP5011 - 910925866554

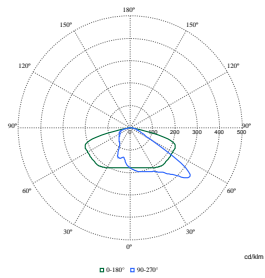

Polar Normal (separate) - BGP5021 - 910925866569

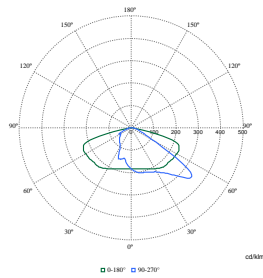

Polar Normal (separate) - BGP5011 - 910925866556

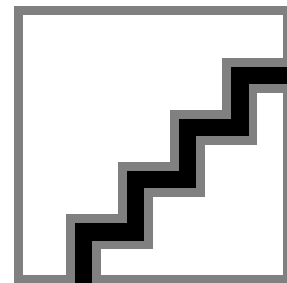

Polar Normal (separate) - BGP5011 - 910925866558

Polar Wide Diagrams

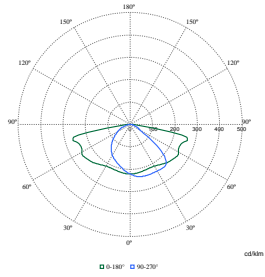

Polar Normal (separate) - BGP5021 - 910925866570

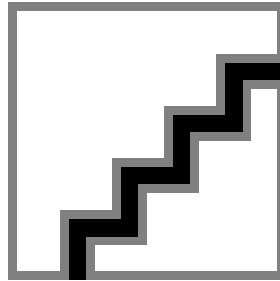

Polar Normal (separate) - BGP5021 - 910925867299

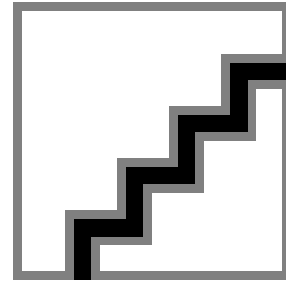

Polar Normal (separate) - BGP5011 - 910925867298

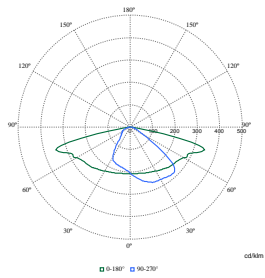

Polar Normal (separate) - BGP5011 - 910925867304

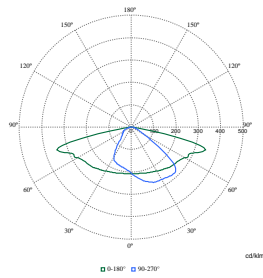

Polar Normal (separate) - BGP5011 - 910925867305

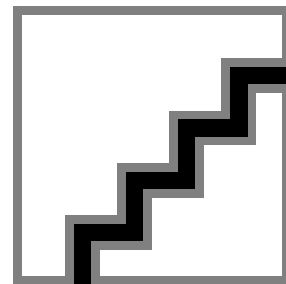

Polar Normal (separate) - BGP5011 - 910925867306

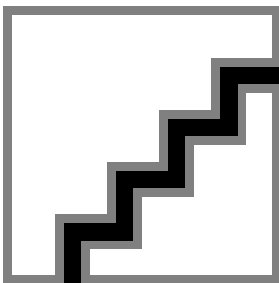

Polar Normal (separate) - BGP5011 - 910925867301

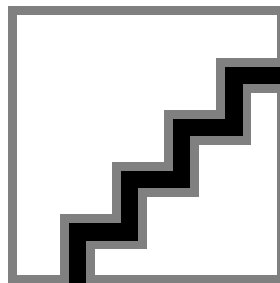

Polar Normal (separate) - BGP5011 - 910925867308

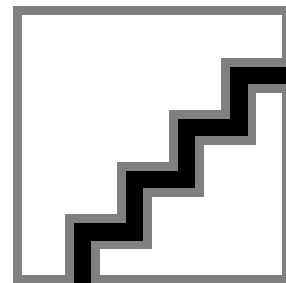

Polar Normal (separate) - BGP5011 - 910925867310

Polar Wide Diagrams

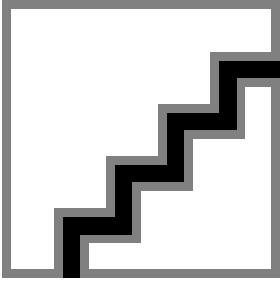

Polar Normal (separate) - BGP501I - 910925867311

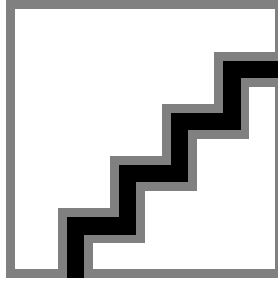

Polar Normal (separate) - BGP501I - 910925867314

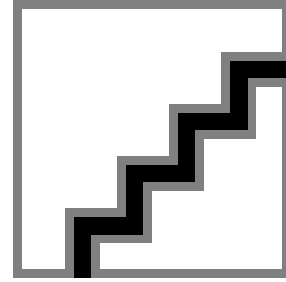

Polar Normal (separate) - BGP501I - 910925867313

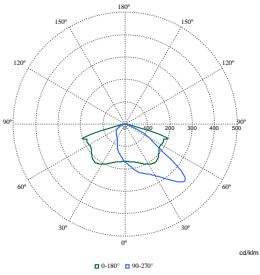

Polar Normal (separate) - BGP502I - 910925867317

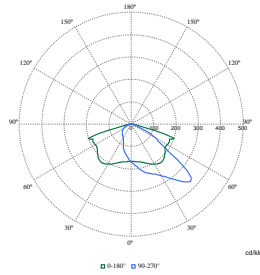

Polar Normal (separate) - BGP502I - 910925867316

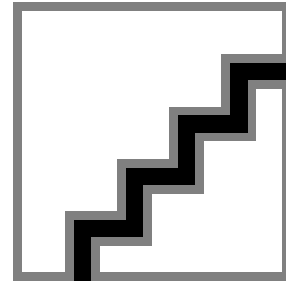

Polar Normal (separate) - BGP502I - 910925867319

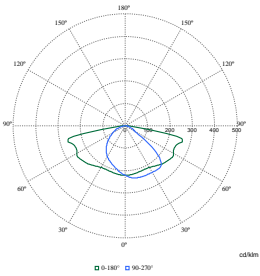

Polar Normal (separate) - BGP502I - 910925867323

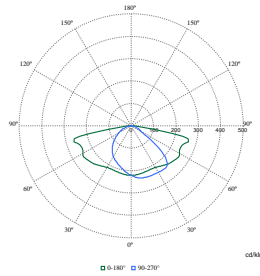

Polar Normal (separate) - BGP502I - 910925867321

