



Éclairage LED rentable et polyvalent

ClearWay Gen2 vous permet de profiter des avantages de la technologie LED pour l'éclairage urbain dès le début. Cette deuxième génération de luminaires s'appuie sur les points forts de son prédécesseur et est conçue pour minimiser davantage votre coût total de possession. ClearWay Gen2 améliore considérablement les aspects les plus importants de l'expérience d'éclairage public par rapport à l'éclairage urbain conventionnel. Idéale pour les nouvelles rues et pour la rénovation d'installations existantes, cette gamme abordable de solutions d'éclairage urbain ClearWay associe un design épuré, une lumière de haute qualité à d'importantes économies d'énergie et de maintenance. En bref, ClearWay gen2 est synonyme de qualité, avec tous les avantages du LED : économies d'énergie et longue durée de vie. Plus d'avantages intégrés dans une conception plus fine et plus légère, ce qui la rend d'autant plus facile à installer.

Avantages

- Série d'avantages réunis dans une architecture de luminaire unique
- Facile à installer
- Faible coût initial
- Coût global d'exploitation raisonnable
- Application Signify Service tag (identification par code QR unique) pour accéder aux informations de maintenance, d'installation et sur les pièces de rechange

Applications

- Zones urbaines et routes résidentielles
- Voies piétonnes et pistes cyclables
- Voies secondaires
- Parkings

Fonctions

- Une conception flexible qui offre différentes options en fonction des besoins de l'application
- Comprend une recette lumineuse dédiée qui préserve le ciel nocturne
- Conception compacte et efficace
- Réglage de l'inclinaison sans avoir besoin d'ouvrir le couvercle

Versions



ClearWay gen2 Performer-BGP307

Schéma dimensionnel

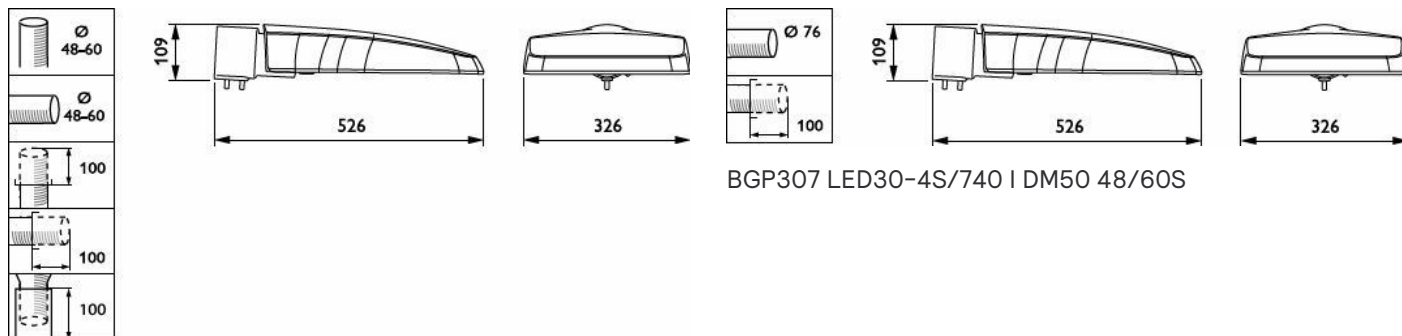

BGP307 LED30-4S/740 I DM50 48/60S

BGP307 LED18-4S/830 II DM11 CLO-DDF1 D18

Informations générales

Source lumineuse remplaçable	Oui
Nombre d'appareillages	1 unité
Ballast/pilote inclus	Oui
Service Tag	Oui

Données techniques de l'éclairage

rendement du flux lumineux vers le haut	0
---	---

Fonctionnement et électricité

Protection contre les surtensions (communes/différentielles)	Niveau de protection contre les surtensions jusqu'à 6 kV en mode différentiel et 8 kV en mode commun
--	--

Mécanique et boîtier

Couleur du boîtier	Gris
Code d'indice de protection	IP66 [Protection contre la pénétration de poussière, protection contre les jets d'eau]
Code de protection contre les chocs méca.	IK09 [10 J]
Angle d'inclinaison standard pour montage au sommet du mât	0°
Fixation latérale pour un angle d'inclinaison standard	0°
Type de cache optique/de lentille	Verre plat

Approbation et application

Essai au fil incandescent	-
Marquage CE	Oui

Performances au fil du temps (conformité à la norme IEC)

Taux de défaillance du driver à 5 000 h 0,5 %

Données du produit

Code de la famille de produits	BGP307 [CLEARWAY GEN2]
--------------------------------	------------------------

Informations générales

Order Code	Full Product Name	Code famille lampe
910925864583	BGP307 LED18-4S/740 I DM50 48/60S	LED18
910925864584	BGP307 LED25-4S/740 I DM50 48/60S	LED25
910925864585	BGP307 LED30-4S/740 I DM50 48/60S	LED30
910925864586	BGP307 LED35-4S/740 I DM50 48/60S	LED35
910925864587	BGP307 LED40-4S/740 I DM50 48/60S	LED40
910925864588	BGP307 LED45-4S/740 I DM50 48/60S	LED45
910925864589	BGP307 LED54-4S/740 I DM50 48/60S	LED54
910925864590	BGP307 LED69-4S/740 I DM50 48/60S	LED69
910925864591	BGP307 LED84-4S/740 I DM50 48/60S	LED84

Order Code	Full Product Name	Code famille lampe
910925864592	BGP307 LED99-4S/740 I DM50 48/60S	LED99
910925864593	BGP307 LED109-4S/740 I DM50 48/60S	LED109
910925864594	BGP307 LED120-4S/740 I DM50 48/60S	LED120
910925864595	BGP307 LED18-4S/740 II DM50 48/60S	LED18
910925864596	BGP307 LED25-4S/740 II DM50 48/60S	LED25
910925864597	BGP307 LED30-4S/740 II DM50 48/60S	LED30
910925864598	BGP307 LED35-4S/740 II DM50 48/60S	LED35
910925864599	BGP307 LED40-4S/740 II DM50 48/60S	LED40
910925864601	BGP307 LED45-4S/740 II DM50 48/60A	LED45
910925864602	BGP307 LED54-4S/740 II DM50 48/60S	LED54
910925864603	BGP307 LED69-4S/740 II DM50 48/60S	LED69
910925864604	BGP307 LED84-4S/740 II DM50 48/60S	LED84
910925864605	BGP307 LED99-4S/740 II DM50 48/60S	LED99
910925864606	BGP307 LED109-4S/740 II DM50 48/60S	LED109
910925864607	BGP307 LED120-4S/740 II DM50 48/60S	LED120
910925865129	BGP307 LED18-4S/740 I DM50 DDF27 D18 48/	LED18
910925865130	BGP307 LED30-4S/740 I DM50 DDF27 D18 48/	LED30
910925865131	BGP307 LED35-4S/740 I DM50 DDF27 D18 48/	LED35
910925865132	BGP307 LED54-4S/740 I DM50 DDF27 D18 48/	LED54
910925865133	BGP307 LED69-4S/740 I DM50 DDF27 D18 48/	LED69
910925865134	BGP307 LED120-4S/740 I DM50 DDF27 D18 48	LED120
910925865210	BGP307 LED18-4S/830 II DM11 CLO 48/60S	LED18
910925865211	BGP307 LED25-4S/830 II DM11 CLO 48/60S	LED25
910925865212	BGP307 LED35-4S/830 II DM11 CLO 48/60S	LED35
910925865213	BGP307 LED45-4S/830 II DM11 CLO 48/60S	LED45
910925865214	BGP307 LED54-4S/830 II DM11 CLO 48/60S	LED54
910925865215	BGP307 LED18-4S/830 II DM11 CLO-DDF1 D18	LED18
910925865216	BGP307 LED25-4S/830 II DM11 CLO-DDF1 D18	LED25
910925865217	BGP307 LED35-4S/830 II DM11 CLO-DDF1 D18	LED35
910925865218	BGP307 LED45-4S/830 II DM11 CLO-DDF1 D18	LED45
910925865219	BGP307 LED54-4S/830 II DM11 CLO-DDF1 D18	LED54
910925865220	BGP307 LED18-4S/830 II DM11 CLO-DDF2 D18	LED18
910925865221	BGP307 LED25-4S/830 II DM11 CLO-DDF2 D18	LED25
910925865222	BGP307 LED35-4S/830 II DM11 CLO-DDF2 D18	LED35
910925865223	BGP307 LED45-4S/830 II DM11 CLO-DDF2 D18	LED45
910925865224	BGP307 LED54-4S/830 II DM11 CLO-DDF2 D18	LED54
910925865225	BGP307 LED18-4S/740 II DM11 CLO 48/60S	LED18
910925865226	BGP307 LED25-4S/740 II DM11 CLO 48/60S	LED25
910925865227	BGP307 LED35-4S/740 II DM11 CLO 48/60S	LED35
910925865228	BGP307 LED45-4S/740 II DM11 CLO 48/60S	LED45

Order Code	Full Product Name	Code famille lampe
910925865229	BGP307 LED54-4S/740 II DM11 CLO 48/60S	LED54
910925865230	BGP307 LED18-4S/740 II DM11 CLO-DDF1 D18	LED18
910925865231	BGP307 LED25-4S/740 II DM11 CLO-DDF1 D18	LED25
910925865232	BGP307 LED35-4S/740 II DM11 CLO-DDF1 D18	LED35
910925865233	BGP307 LED45-4S/740 II DM11 CLO-DDF1 D18	LED45
910925865234	BGP307 LED54-4S/740 II DM11 CLO-DDF1 D18	LED54
910925865235	BGP307 LED18-4S/740 II DM11 CLO-DDF2 D18	LED18
910925865236	BGP307 LED25-4S/740 II DM11 CLO-DDF2 D18	LED25
910925865237	BGP307 LED35-4S/740 II DM11 CLO-DDF2 D18	LED35
910925865238	BGP307 LED45-4S/740 II DM11 CLO-DDF2 D18	LED45
910925865239	BGP307 LED54-4S/740 II DM11 CLO-DDF2 D18	LED54
910925865240	BGP307 LED69-4S/740 II DM11 CLO 48/60S	LED69
910925865241	BGP307 LED84-4S/740 II DM11 CLO 48/60S	LED84
910925865242	BGP307 LED99-4S/740 II DM11 CLO 48/60S	LED99
910925865243	BGP307 LED109-4S/740 II DM11 CLO 48/60S	LED109
910925865244	BGP307 LED120-4S/740 II DM11 CLO 48/60S	LED120
910925865245	BGP307 LED69-4S/740 II DM11 CLO-DDF1 D18	LED69
910925865246	BGP307 LED84-4S/740 II DM11 CLO-DDF1 D18	LED84
910925865247	BGP307 LED99-4S/740 II DM11 CLO-DDF1 D18	LED99
910925865248	BGP307 LED109-4S/740 II DM11 CLO-DDF1 D1	LED109
910925865249	BGP307 LED120-4S/740 II DM11 CLO-DDF1 D1	LED120
910925865250	BGP307 LED69-4S/740 II DM11 CLO-DDF2 D18	LED69
910925865251	BGP307 LED84-4S/740 II DM11 CLO-DDF2 D18	LED84
910925865252	BGP307 LED99-4S/740 II DM11 CLO-DDF2 D18	LED99
910925865253	BGP307 LED109-4S/740 II DM11 CLO-DDF2 D1	LED109
910925865254	BGP307 LED120-4S/740 II DM11 CLO-DDF2 D1	LED120
910925865522	BGP307 LED120-4S/740 II DM11 CLO-DDF2 D1	LED120

Données techniques de l'éclairage

Order Code	Full Product Name	Flux lumineux	Température de couleur corréélée (nom.)	Indice de rendu de couleur (IRC)	Température de couleur	Diffusion du faisceau de lumière du luminaire	Type d'optique extérieur
910925864583	BGP307 LED18-4S/740 I DM50 48/60S	1 584 lm	4000 K	70	740 blanc neutre	154° - 31° x 54°	Distribution semi-intensive 50
910925864584	BGP307 LED25-4S/740 I DM50 48/60S	2 175 lm	4000 K	70	740 blanc neutre	154° - 31° x 54°	Distribution semi-intensive 50
910925864585	BGP307 LED30-4S/740 I DM50 48/60S	2 610 lm	4000 K	70	740 blanc neutre	154° - 31° x 54°	Distribution semi-intensive 50

Order Code	Full Product Name	Flux lumineux	Température de couleur corrélée (nom.)	Indice de rendu de couleur (IRC)	Température de couleur	Diffusion du faisceau de lumière du luminaire	Type d'optique extérieur
910925864586	BGP307 LED35-4S/740 I DM50 48/60S	3 080 lm	4000 K	70	740 blanc neutre	154° - 31° x 54°	Distribution semi-intensive 50
910925864587	BGP307 LED40-4S/740 I DM50 48/60S	3 520 lm	4000 K	70	740 blanc neutre	154° - 31° x 54°	Distribution semi-intensive 50
910925864588	BGP307 LED45-4S/740 I DM50 48/60S	3 960 lm	4000 K	70	740 blanc neutre	154° - 31° x 54°	Distribution semi-intensive 50
910925864589	BGP307 LED54-4S/740 I DM50 48/60S	4 698 lm	4000 K	70	740 blanc neutre	154° - 31° x 54°	Distribution semi-intensive 50
910925864590	BGP307 LED69-4S/740 I DM50 48/60S	6 160 lm	4000 K	70	740 blanc neutre	154° - 31° x 54°	Distribution semi-intensive 50
910925864591	BGP307 LED84-4S/740 I DM50 48/60S	7 308 lm	4000 K	70	740 blanc neutre	154° - 31° x 54°	Distribution semi-intensive 50
910925864592	BGP307 LED99-4S/740 I DM50 48/60S	8 600 lm	4000 K	70	740 blanc neutre	154° - 31° x 54°	Distribution semi-intensive 50
910925864593	BGP307 LED109-4S/740 I DM50 48/60S	9 460 lm	4000 K	70	740 blanc neutre	154° - 31° x 54°	Distribution semi-intensive 50
910925864594	BGP307 LED120-4S/740 I DM50 48/60S	10 200 lm	4000 K	70	740 blanc neutre	154° - 31° x 54°	Distribution semi-intensive 50
910925864595	BGP307 LED18-4S/740 II DM50 48/60S	1 584 lm	4000 K	70	740 blanc neutre	154° - 31° x 54°	Distribution semi-intensive 50
910925864596	BGP307 LED25-4S/740 II DM50 48/60S	2 175 lm	4000 K	70	740 blanc neutre	154° - 31° x 54°	Distribution semi-intensive 50
910925864597	BGP307 LED30-4S/740 II DM50 48/60S	2 610 lm	4000 K	70	740 blanc neutre	154° - 31° x 54°	Distribution semi-intensive 50
910925864598	BGP307 LED35-4S/740 II DM50 48/60S	3 080 lm	4000 K	70	740 blanc neutre	154° - 31° x 54°	Distribution semi-intensive 50
910925864599	BGP307 LED40-4S/740 II DM50 48/60S	3 520 lm	4000 K	70	740 blanc neutre	154° - 31° x 54°	Distribution semi-intensive 50
910925864601	BGP307 LED45-4S/740 II DM50 48/60A	3 960 lm	4000 K	70	740 blanc neutre	154° - 31° x 54°	Distribution semi-intensive 50
910925864602	BGP307 LED54-4S/740 II DM50 48/60S	4 698 lm	4000 K	70	740 blanc neutre	154° - 31° x 54°	Distribution semi-intensive 50
910925864603	BGP307 LED69-4S/740 II DM50 48/60S	6 160 lm	4000 K	70	740 blanc neutre	154° - 31° x 54°	Distribution semi-intensive 50
910925864604	BGP307 LED84-4S/740 II DM50 48/60S	7 308 lm	4000 K	70	740 blanc neutre	154° - 31° x 54°	Distribution semi-intensive 50
910925864605	BGP307 LED99-4S/740 II DM50 48/60S	8 600 lm	4000 K	70	740 blanc neutre	154° - 31° x 54°	Distribution semi-intensive 50
910925864606	BGP307 LED109-4S/740 II DM50 48/60S	9 460 lm	4000 K	70	740 blanc neutre	154° - 31° x 54°	Distribution semi-intensive 50
910925864607	BGP307 LED120-4S/740 II DM50 48/60S	10 200 lm	4000 K	70	740 blanc neutre	154° - 31° x 54°	Distribution semi-intensive 50
910925865129	BGP307 LED18-4S/740 I DM50 DDF27 D18 48/	1 584 lm	4000 K	70	740 blanc neutre	154° - 31° x 54°	Distribution semi-intensive 50

Order Code	Full Product Name	Flux lumineux	Température de couleur corrélée (nom.)	Indice de rendu de couleur (IRC)	Température de couleur	Diffusion du faisceau de lumière du luminaire	Type d'optique extérieur
910925865130	BGP307 LED30-4S/740 I DM50 DDF27 D18 48/	2 610 lm	4000 K	70	740 blanc neutre	154° - 31° x 54°	Distribution semi-intensive 50
910925865131	BGP307 LED35-4S/740 I DM50 DDF27 D18 48/	3 080 lm	4000 K	70	740 blanc neutre	154° - 31° x 54°	Distribution semi-intensive 50
910925865132	BGP307 LED54-4S/740 I DM50 DDF27 D18 48/	4 698 lm	4000 K	70	740 blanc neutre	154° - 31° x 54°	Distribution semi-intensive 50
910925865133	BGP307 LED69-4S/740 I DM50 DDF27 D18 48/	6 160 lm	4000 K	70	740 blanc neutre	154° - 31° x 54°	Distribution semi-intensive 50
910925865134	BGP307 LED120-4S/740 I DM50 DDF27 D18 48	10 200 lm	4000 K	70	740 blanc neutre	154° - 31° x 54°	Distribution semi-intensive 50
910925865210	BGP307 LED18-4S/830 II DM11 CLO 48/60S	1 522,5 lm	3000 K	80	830 blanc chaud	160° - 42° x 54°	Distribution semi-intensive 11
910925865211	BGP307 LED25-4S/830 II DM11 CLO 48/60S	2 088 lm	3000 K	80	830 blanc chaud	160° - 42° x 54°	Distribution semi-intensive 11
910925865212	BGP307 LED35-4S/830 II DM11 CLO 48/60S	2 958 lm	3000 K	80	830 blanc chaud	160° - 42° x 54°	Distribution semi-intensive 11
910925865213	BGP307 LED45-4S/830 II DM11 CLO 48/60S	3 741 lm	3000 K	80	830 blanc chaud	160° - 42° x 54°	Distribution semi-intensive 11
910925865214	BGP307 LED54-4S/830 II DM11 CLO 48/60S	4 524 lm	3000 K	80	830 blanc chaud	160° - 42° x 54°	Distribution semi-intensive 11
910925865215	BGP307 LED18-4S/830 II DM11 CLO-DDF1 D18	1 522,5 lm	3000 K	80	830 blanc chaud	160° - 42° x 54°	Distribution semi-intensive 11
910925865216	BGP307 LED25-4S/830 II DM11 CLO-DDF1 D18	2 088 lm	3000 K	80	830 blanc chaud	160° - 42° x 54°	Distribution semi-intensive 11
910925865217	BGP307 LED35-4S/830 II DM11 CLO-DDF1 D18	2 958 lm	3000 K	80	830 blanc chaud	160° - 42° x 54°	Distribution semi-intensive 11
910925865218	BGP307 LED45-4S/830 II DM11 CLO-DDF1 D18	3 741 lm	3000 K	80	830 blanc chaud	160° - 42° x 54°	Distribution semi-intensive 11
910925865219	BGP307 LED54-4S/830 II DM11 CLO-DDF1 D18	4 524 lm	3000 K	80	830 blanc chaud	160° - 42° x 54°	Distribution semi-intensive 11
910925865220	BGP307 LED18-4S/830 II DM11 CLO-DDF2 D18	1 522,5 lm	3000 K	80	830 blanc chaud	160° - 42° x 54°	Distribution semi-intensive 11
910925865221	BGP307 LED25-4S/830 II DM11 CLO-DDF2 D18	2 088 lm	3000 K	80	830 blanc chaud	160° - 42° x 54°	Distribution semi-intensive 11
910925865222	BGP307 LED35-4S/830 II DM11 CLO-DDF2 D18	2 958 lm	3000 K	80	830 blanc chaud	160° - 42° x 54°	Distribution semi-intensive 11
910925865223	BGP307 LED45-4S/830 II DM11 CLO-DDF2 D18	3 741 lm	3000 K	80	830 blanc chaud	160° - 42° x 54°	Distribution semi-intensive 11
910925865224	BGP307 LED54-4S/830 II DM11 CLO-DDF2 D18	4 524 lm	3000 K	80	830 blanc chaud	160° - 42° x 54°	Distribution semi-intensive 11
910925865225	BGP307 LED18-4S/740 II DM11 CLO 48/60S	1 522,5 lm	4000 K	70	740 blanc neutre	160° - 42° x 54°	Distribution semi-intensive 11
910925865226	BGP307 LED25-4S/740 II DM11 CLO 48/60S	2 088 lm	4000 K	70	740 blanc neutre	160° - 42° x 54°	Distribution semi-intensive 11

Order Code	Full Product Name	Flux lumineux	Température de couleur corrélée (nom.)	Indice de rendu de couleur (IRC)	Température de couleur	Diffusion du faisceau de lumière du luminaire	Type d'optique extérieur
910925865227	BGP307 LED35-4S/740 II DM11 CLO 48/60S	2 958 lm	4000 K	70	740 blanc neutre	160° - 42° x 54°	Distribution semi-intensive 11
910925865228	BGP307 LED45-4S/740 II DM11 CLO 48/60S	3 828 lm	4000 K	70	740 blanc neutre	160° - 42° x 54°	Distribution semi-intensive 11
910925865229	BGP307 LED54-4S/740 II DM11 CLO 48/60S	4 524 lm	4000 K	70	740 blanc neutre	160° - 42° x 54°	Distribution semi-intensive 11
910925865230	BGP307 LED18-4S/740 II DM11 CLO-DDF1 D18	1 522,5 lm	4000 K	70	740 blanc neutre	160° - 42° x 54°	Distribution semi-intensive 11
910925865231	BGP307 LED25-4S/740 II DM11 CLO-DDF1 D18	2 088 lm	4000 K	70	740 blanc neutre	160° - 42° x 54°	Distribution semi-intensive 11
910925865232	BGP307 LED35-4S/740 II DM11 CLO-DDF1 D18	2 958 lm	4000 K	70	740 blanc neutre	160° - 42° x 54°	Distribution semi-intensive 11
910925865233	BGP307 LED45-4S/740 II DM11 CLO-DDF1 D18	3 828 lm	4000 K	70	740 blanc neutre	160° - 42° x 54°	Distribution semi-intensive 11
910925865234	BGP307 LED54-4S/740 II DM11 CLO-DDF1 D18	4 524 lm	4000 K	70	740 blanc neutre	160° - 42° x 54°	Distribution semi-intensive 11
910925865235	BGP307 LED18-4S/740 II DM11 CLO-DDF2 D18	1 522,5 lm	4000 K	70	740 blanc neutre	160° - 42° x 54°	Distribution semi-intensive 11
910925865236	BGP307 LED25-4S/740 II DM11 CLO-DDF2 D18	2 088 lm	4000 K	70	740 blanc neutre	160° - 42° x 54°	Distribution semi-intensive 11
910925865237	BGP307 LED35-4S/740 II DM11 CLO-DDF2 D18	2 958 lm	4000 K	70	740 blanc neutre	160° - 42° x 54°	Distribution semi-intensive 11
910925865238	BGP307 LED45-4S/740 II DM11 CLO-DDF2 D18	3 828 lm	4000 K	70	740 blanc neutre	160° - 42° x 54°	Distribution semi-intensive 11
910925865239	BGP307 LED54-4S/740 II DM11 CLO-DDF2 D18	4 524 lm	4000 K	70	740 blanc neutre	160° - 42° x 54°	Distribution semi-intensive 11
910925865240	BGP307 LED69-4S/740 II DM11 CLO 48/60S	5 916 lm	4000 K	70	740 blanc neutre	160° - 42° x 54°	Distribution semi-intensive 11
910925865241	BGP307 LED84-4S/740 II DM11 CLO 48/60S	7 134 lm	4000 K	70	740 blanc neutre	160° - 42° x 54°	Distribution semi-intensive 11
910925865242	BGP307 LED99-4S/740 II DM11 CLO 48/60S	8 256 lm	4000 K	70	740 blanc neutre	160° - 42° x 54°	Distribution semi-intensive 11
910925865243	BGP307 LED109-4S/740 II DM11 CLO 48/60S	9 030 lm	4000 K	70	740 blanc neutre	160° - 42° x 54°	Distribution semi-intensive 11
910925865244	BGP307 LED120-4S/740 II DM11 CLO 48/60S	9 775 lm	4000 K	70	740 blanc neutre	160° - 42° x 54°	Distribution semi-intensive 11
910925865245	BGP307 LED69-4S/740 II DM11 CLO-DDF1 D18	5 916 lm	4000 K	70	740 blanc neutre	160° - 42° x 54°	Distribution semi-intensive 11
910925865246	BGP307 LED84-4S/740 II DM11 CLO-DDF1 D18	7 134 lm	4000 K	70	740 blanc neutre	160° - 42° x 54°	Distribution semi-intensive 11
910925865247	BGP307 LED99-4S/740 II DM11 CLO-DDF1 D18	8 256 lm	4000 K	70	740 blanc neutre	160° - 42° x 54°	Distribution semi-intensive 11
910925865248	BGP307 LED109-4S/740 II DM11 CLO-DDF1 D1	9 030 lm	4000 K	70	740 blanc neutre	160° - 42° x 54°	Distribution semi-intensive 11

Order Code	Full Product Name	Flux lumineux	Température de couleur corrélée (nom.)	Indice de rendu de couleur (IRC)	Température de couleur	Diffusion du faisceau de lumière du luminaire	Type d'optique extérieur
910925865249	BGP307 LED120-4S/740 II DM11 CLO-DDF1 D1	9 775 lm	4000 K	70	740 blanc neutre	160° - 42° x 54°	Distribution semi-intensive 11
910925865250	BGP307 LED69-4S/740 II DM11 CLO-DDF2 D18	5 916 lm	4000 K	70	740 blanc neutre	160° - 42° x 54°	Distribution semi-intensive 11
910925865251	BGP307 LED84-4S/740 II DM11 CLO-DDF2 D18	7 134 lm	4000 K	70	740 blanc neutre	160° - 42° x 54°	Distribution semi-intensive 11
910925865252	BGP307 LED99-4S/740 II DM11 CLO-DDF2 D18	8 256 lm	4000 K	70	740 blanc neutre	160° - 42° x 54°	Distribution semi-intensive 11
910925865253	BGP307 LED109-4S/740 II DM11 CLO-DDF2 D1	9 030 lm	4000 K	70	740 blanc neutre	160° - 42° x 54°	Distribution semi-intensive 11
910925865254	BGP307 LED120-4S/740 II DM11 CLO-DDF2 D1	9 775 lm	4000 K	70	740 blanc neutre	160° - 42° x 54°	Distribution semi-intensive 11
910925865522	BGP307 LED120-4S/740 II DM11 CLO-DDF2 D1	9 775 lm	4000 K	70	740 blanc neutre	160° - 42° x 54°	Distribution semi-intensive 11

Fonctionnement et électricité

Order Code	Full Product Name	Consommation électrique
910925864583	BGP307 LED18-4S/740 I DM50 48/60S	11,6 W
910925864584	BGP307 LED25-4S/740 I DM50 48/60S	16,2 W
910925864585	BGP307 LED30-4S/740 I DM50 48/60S	19,6 W
910925864586	BGP307 LED35-4S/740 I DM50 48/60S	21,5 W
910925864587	BGP307 LED40-4S/740 I DM50 48/60S	24,5 W
910925864588	BGP307 LED45-4S/740 I DM50 48/60S	27,5 W
910925864589	BGP307 LED54-4S/740 I DM50 48/60S	33,5 W
910925864590	BGP307 LED69-4S/740 I DM50 48/60S	40,5 W
910925864591	BGP307 LED84-4S/740 I DM50 48/60S	49,5 W
910925864592	BGP307 LED99-4S/740 I DM50 48/60S	59 W
910925864593	BGP307 LED109-4S/740 I DM50 48/60S	65 W
910925864594	BGP307 LED120-4S/740 I DM50 48/60S	72 W
910925864595	BGP307 LED18-4S/740 II DM50 48/60S	11,6 W
910925864596	BGP307 LED25-4S/740 II DM50 48/60S	16,2 W
910925864597	BGP307 LED30-4S/740 II DM50 48/60S	19,6 W
910925864598	BGP307 LED35-4S/740 II DM50 48/60S	21,5 W
910925864599	BGP307 LED40-4S/740 II DM50 48/60S	24,5 W
910925864601	BGP307 LED45-4S/740 II DM50 48/60A	27,5 W
910925864602	BGP307 LED54-4S/740 II DM50 48/60S	33,5 W
910925864603	BGP307 LED69-4S/740 II DM50 48/60S	40,5 W
910925864604	BGP307 LED84-4S/740 II DM50 48/60S	49,5 W

Order Code	Full Product Name	Consommation électrique
910925864605	BGP307 LED99-4S/740 II DM50 48/60S	59 W
910925864606	BGP307 LED109-4S/740 II DM50 48/60S	65 W
910925864607	BGP307 LED120-4S/740 II DM50 48/60S	72 W
910925865129	BGP307 LED18-4S/740 I DM50 DDF27 D18 48/	11,6 W
910925865130	BGP307 LED30-4S/740 I DM50 DDF27 D18 48/	19,6 W
910925865131	BGP307 LED35-4S/740 I DM50 DDF27 D18 48/	21,5 W
910925865132	BGP307 LED54-4S/740 I DM50 DDF27 D18 48/	33,5 W
910925865133	BGP307 LED69-4S/740 I DM50 DDF27 D18 48/	40,5 W
910925865134	BGP307 LED120-4S/740 I DM50 DDF27 D18 48	72 W
910925865210	BGP307 LED18-4S/830 II DM11 CLO 48/60S	14,4 W
910925865211	BGP307 LED25-4S/830 II DM11 CLO 48/60S	20 W
910925865212	BGP307 LED35-4S/830 II DM11 CLO 48/60S	26,5 W
910925865213	BGP307 LED45-4S/830 II DM11 CLO 48/60S	34,5 W
910925865214	BGP307 LED54-4S/830 II DM11 CLO 48/60S	39 W
910925865215	BGP307 LED18-4S/830 II DM11 CLO-DDF1 D18	14,4 W
910925865216	BGP307 LED25-4S/830 II DM11 CLO-DDF1 D18	20 W
910925865217	BGP307 LED35-4S/830 II DM11 CLO-DDF1 D18	26,5 W
910925865218	BGP307 LED45-4S/830 II DM11 CLO-DDF1 D18	34,5 W
910925865219	BGP307 LED54-4S/830 II DM11 CLO-DDF1 D18	39 W
910925865220	BGP307 LED18-4S/830 II DM11 CLO-DDF2 D18	14,4 W
910925865221	BGP307 LED25-4S/830 II DM11 CLO-DDF2 D18	20 W
910925865222	BGP307 LED35-4S/830 II DM11 CLO-DDF2 D18	26,5 W
910925865223	BGP307 LED45-4S/830 II DM11 CLO-DDF2 D18	34,5 W
910925865224	BGP307 LED54-4S/830 II DM11 CLO-DDF2 D18	39 W
910925865225	BGP307 LED18-4S/740 II DM11 CLO 48/60S	11,4 W
910925865226	BGP307 LED25-4S/740 II DM11 CLO 48/60S	15,6 W
910925865227	BGP307 LED35-4S/740 II DM11 CLO 48/60S	21 W
910925865228	BGP307 LED45-4S/740 II DM11 CLO 48/60S	27 W
910925865229	BGP307 LED54-4S/740 II DM11 CLO 48/60S	32 W
910925865230	BGP307 LED18-4S/740 II DM11 CLO-DDF1 D18	11,4 W
910925865231	BGP307 LED25-4S/740 II DM11 CLO-DDF1 D18	15,6 W
910925865232	BGP307 LED35-4S/740 II DM11 CLO-DDF1 D18	21 W
910925865233	BGP307 LED45-4S/740 II DM11 CLO-DDF1 D18	27 W
910925865234	BGP307 LED54-4S/740 II DM11 CLO-DDF1 D18	32 W
910925865235	BGP307 LED18-4S/740 II DM11 CLO-DDF2 D18	11,4 W
910925865236	BGP307 LED25-4S/740 II DM11 CLO-DDF2 D18	15,6 W
910925865237	BGP307 LED35-4S/740 II DM11 CLO-DDF2 D18	21 W
910925865238	BGP307 LED45-4S/740 II DM11 CLO-DDF2 D18	27 W
910925865239	BGP307 LED54-4S/740 II DM11 CLO-DDF2 D18	32 W
910925865240	BGP307 LED69-4S/740 II DM11 CLO 48/60S	39,5 W

Order Code	Full Product Name	Consommation électrique
910925865241	BGP307 LED84-4S/740 II DM11 CLO 48/60S	48 W
910925865242	BGP307 LED99-4S/740 II DM11 CLO 48/60S	56 W
910925865243	BGP307 LED109-4S/740 II DM11 CLO 48/60S	62 W
910925865244	BGP307 LED120-4S/740 II DM11 CLO 48/60S	69 W
910925865245	BGP307 LED69-4S/740 II DM11 CLO-DDF1 D18	39,5 W
910925865246	BGP307 LED84-4S/740 II DM11 CLO-DDF1 D18	48 W
910925865247	BGP307 LED99-4S/740 II DM11 CLO-DDF1 D18	56 W
910925865248	BGP307 LED109-4S/740 II DM11 CLO-DDF1 D1	62 W
910925865249	BGP307 LED120-4S/740 II DM11 CLO-DDF1 D1	69 W
910925865250	BGP307 LED69-4S/740 II DM11 CLO-DDF2 D18	39,5 W
910925865251	BGP307 LED84-4S/740 II DM11 CLO-DDF2 D18	48 W
910925865252	BGP307 LED99-4S/740 II DM11 CLO-DDF2 D18	56 W
910925865253	BGP307 LED109-4S/740 II DM11 CLO-DDF2 D1	62 W
910925865254	BGP307 LED120-4S/740 II DM11 CLO-DDF2 D1	69 W
910925865522	BGP307 LED120-4S/740 II DM11 CLO-DDF2 D1	69 W

Commandes et gradation

Order Code	Full Product Name	Variation de l'intensité lumineuse	Niveau de gradation maximal
910925864583	BGP307 LED18-4S/740 I DM50 48/60S	Non	Non applicable
910925864584	BGP307 LED25-4S/740 I DM50 48/60S	Non	Non applicable
910925864585	BGP307 LED30-4S/740 I DM50 48/60S	Non	Non applicable
910925864586	BGP307 LED35-4S/740 I DM50 48/60S	Non	Non applicable
910925864587	BGP307 LED40-4S/740 I DM50 48/60S	Non	Non applicable
910925864588	BGP307 LED45-4S/740 I DM50 48/60S	Non	Non applicable
910925864589	BGP307 LED54-4S/740 I DM50 48/60S	Non	Non applicable
910925864590	BGP307 LED69-4S/740 I DM50 48/60S	Non	Non applicable
910925864591	BGP307 LED84-4S/740 I DM50 48/60S	Non	Non applicable
910925864592	BGP307 LED99-4S/740 I DM50 48/60S	Non	Non applicable
910925864593	BGP307 LED109-4S/740 I DM50 48/60S	Non	Non applicable
910925864594	BGP307 LED120-4S/740 I DM50 48/60S	Non	Non applicable
910925864595	BGP307 LED18-4S/740 II DM50 48/60S	Non	Non applicable
910925864596	BGP307 LED25-4S/740 II DM50 48/60S	Non	Non applicable
910925864597	BGP307 LED30-4S/740 II DM50 48/60S	Non	Non applicable
910925864598	BGP307 LED35-4S/740 II DM50 48/60S	Non	Non applicable
910925864599	BGP307 LED40-4S/740 II DM50 48/60S	Non	Non applicable
910925864601	BGP307 LED45-4S/740 II DM50 48/60A	Non	Non applicable
910925864602	BGP307 LED54-4S/740 II DM50 48/60S	Non	Non applicable
910925864603	BGP307 LED69-4S/740 II DM50 48/60S	Non	Non applicable
910925864604	BGP307 LED84-4S/740 II DM50 48/60S	Non	Non applicable

Order Code	Full Product Name	Variation de l'intensité lumineuse	Niveau de gradation maximal
910925864605	BGP307 LED99-4S/740 II DM50 48/60S	Non	Non applicable
910925864606	BGP307 LED109-4S/740 II DM50 48/60S	Non	Non applicable
910925864607	BGP307 LED120-4S/740 II DM50 48/60S	Non	Non applicable
910925865129	BGP307 LED18-4S/740 I DM50 DDF27 D18 48/	Oui	0 % (numérique)
910925865130	BGP307 LED30-4S/740 I DM50 DDF27 D18 48/	Oui	0 % (numérique)
910925865131	BGP307 LED35-4S/740 I DM50 DDF27 D18 48/	Oui	0 % (numérique)
910925865132	BGP307 LED54-4S/740 I DM50 DDF27 D18 48/	Oui	0 % (numérique)
910925865133	BGP307 LED69-4S/740 I DM50 DDF27 D18 48/	Oui	0 % (numérique)
910925865134	BGP307 LED120-4S/740 I DM50 DDF27 D18 48	Oui	0 % (numérique)
910925865210	BGP307 LED18-4S/830 II DM11 CLO 48/60S	Non	0 % (numérique)
910925865211	BGP307 LED25-4S/830 II DM11 CLO 48/60S	Non	0 % (numérique)
910925865212	BGP307 LED35-4S/830 II DM11 CLO 48/60S	Non	0 % (numérique)
910925865213	BGP307 LED45-4S/830 II DM11 CLO 48/60S	Non	0 % (numérique)
910925865214	BGP307 LED54-4S/830 II DM11 CLO 48/60S	Non	0 % (numérique)
910925865215	BGP307 LED18-4S/830 II DM11 CLO-DDF1 D18	Oui	0 % (numérique)
910925865216	BGP307 LED25-4S/830 II DM11 CLO-DDF1 D18	Oui	0 % (numérique)
910925865217	BGP307 LED35-4S/830 II DM11 CLO-DDF1 D18	Oui	0 % (numérique)
910925865218	BGP307 LED45-4S/830 II DM11 CLO-DDF1 D18	Oui	0 % (numérique)
910925865219	BGP307 LED54-4S/830 II DM11 CLO-DDF1 D18	Oui	0 % (numérique)
910925865220	BGP307 LED18-4S/830 II DM11 CLO-DDF2 D18	Oui	0 % (numérique)
910925865221	BGP307 LED25-4S/830 II DM11 CLO-DDF2 D18	Oui	0 % (numérique)
910925865222	BGP307 LED35-4S/830 II DM11 CLO-DDF2 D18	Oui	0 % (numérique)
910925865223	BGP307 LED45-4S/830 II DM11 CLO-DDF2 D18	Oui	0 % (numérique)
910925865224	BGP307 LED54-4S/830 II DM11 CLO-DDF2 D18	Oui	0 % (numérique)
910925865225	BGP307 LED18-4S/740 II DM11 CLO 48/60S	Non	0 % (numérique)
910925865226	BGP307 LED25-4S/740 II DM11 CLO 48/60S	Non	0 % (numérique)
910925865227	BGP307 LED35-4S/740 II DM11 CLO 48/60S	Non	0 % (numérique)
910925865228	BGP307 LED45-4S/740 II DM11 CLO 48/60S	Non	0 % (numérique)
910925865229	BGP307 LED54-4S/740 II DM11 CLO 48/60S	Non	0 % (numérique)
910925865230	BGP307 LED18-4S/740 II DM11 CLO-DDF1 D18	Oui	0 % (numérique)
910925865231	BGP307 LED25-4S/740 II DM11 CLO-DDF1 D18	Oui	0 % (numérique)
910925865232	BGP307 LED35-4S/740 II DM11 CLO-DDF1 D18	Oui	0 % (numérique)
910925865233	BGP307 LED45-4S/740 II DM11 CLO-DDF1 D18	Oui	0 % (numérique)
910925865234	BGP307 LED54-4S/740 II DM11 CLO-DDF1 D18	Oui	0 % (numérique)
910925865235	BGP307 LED18-4S/740 II DM11 CLO-DDF2 D18	Oui	0 % (numérique)
910925865236	BGP307 LED25-4S/740 II DM11 CLO-DDF2 D18	Oui	0 % (numérique)
910925865237	BGP307 LED35-4S/740 II DM11 CLO-DDF2 D18	Oui	0 % (numérique)
910925865238	BGP307 LED45-4S/740 II DM11 CLO-DDF2 D18	Oui	0 % (numérique)
910925865239	BGP307 LED54-4S/740 II DM11 CLO-DDF2 D18	Oui	0 % (numérique)
910925865240	BGP307 LED69-4S/740 II DM11 CLO 48/60S	Non	0 % (numérique)

Order Code	Full Product Name	Variation de l'intensité lumineuse	Niveau de gradation maximal
910925865241	BGP307 LED84-4S/740 II DM11 CLO 48/60S	Non	0 % (numérique)
910925865242	BGP307 LED99-4S/740 II DM11 CLO 48/60S	Non	0 % (numérique)
910925865243	BGP307 LED109-4S/740 II DM11 CLO 48/60S	Non	0 % (numérique)
910925865244	BGP307 LED120-4S/740 II DM11 CLO 48/60S	Non	0 % (numérique)
910925865245	BGP307 LED69-4S/740 II DM11 CLO-DDF1 D18	Oui	0 % (numérique)
910925865246	BGP307 LED84-4S/740 II DM11 CLO-DDF1 D18	Oui	0 % (numérique)
910925865247	BGP307 LED99-4S/740 II DM11 CLO-DDF1 D18	Oui	0 % (numérique)
910925865248	BGP307 LED109-4S/740 II DM11 CLO-DDF1 D1	Oui	0 % (numérique)
910925865249	BGP307 LED120-4S/740 II DM11 CLO-DDF1 D1	Oui	0 % (numérique)
910925865250	BGP307 LED69-4S/740 II DM11 CLO-DDF2 D18	Oui	0 % (numérique)
910925865251	BGP307 LED84-4S/740 II DM11 CLO-DDF2 D18	Oui	0 % (numérique)
910925865252	BGP307 LED99-4S/740 II DM11 CLO-DDF2 D18	Oui	0 % (numérique)
910925865253	BGP307 LED109-4S/740 II DM11 CLO-DDF2 D1	Oui	0 % (numérique)
910925865254	BGP307 LED120-4S/740 II DM11 CLO-DDF2 D1	Oui	0 % (numérique)
910925865522	BGP307 LED120-4S/740 II DM11 CLO-DDF2 D1	Oui	0 % (numérique)

Diagramme photométrique polaire

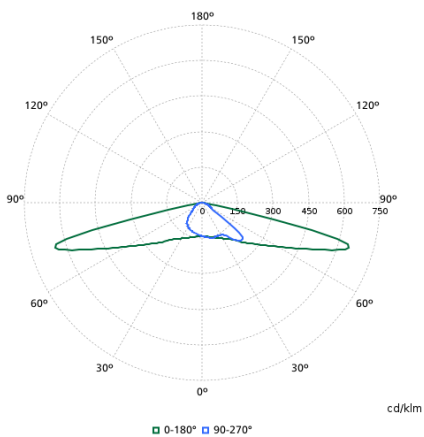

BGP307I - 910925864604

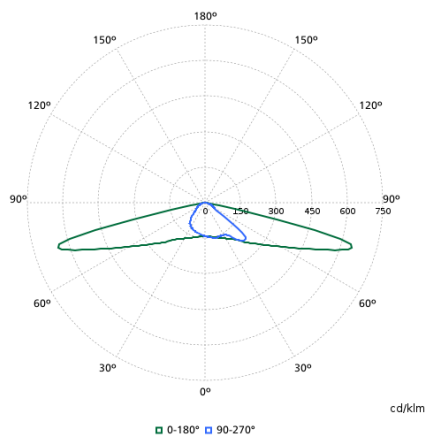

BGP307I - 910925864592

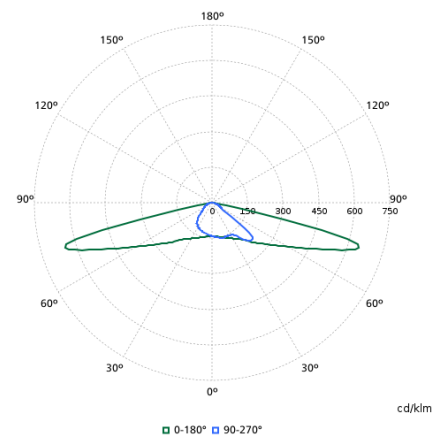

BGP307I - 910925864597

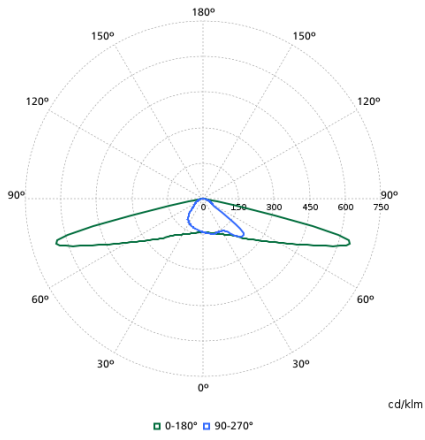

BGP307I - 910925864587

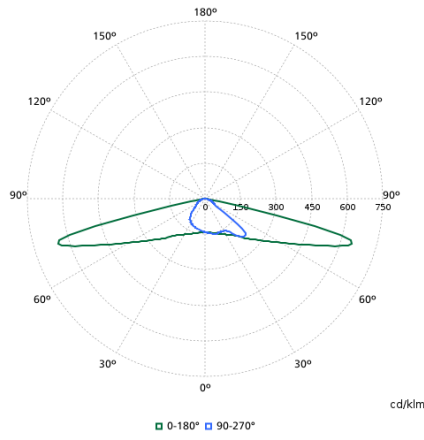

BGP307I - 910925864586

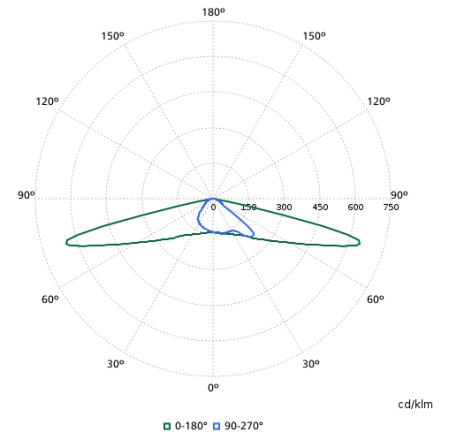

BGP307I - 910925864590

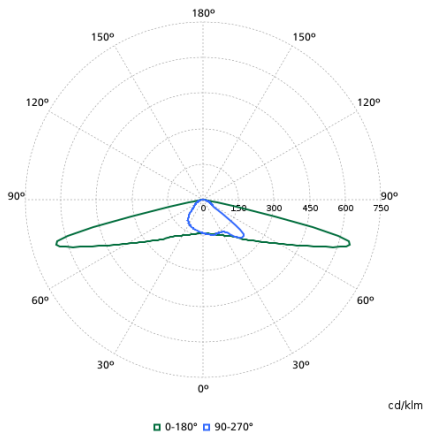

BGP307I - 910925865134

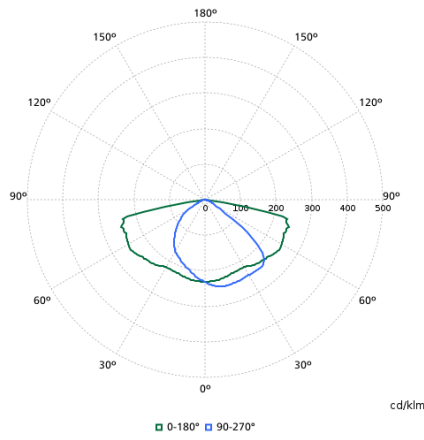

BGP307I - 910925865226

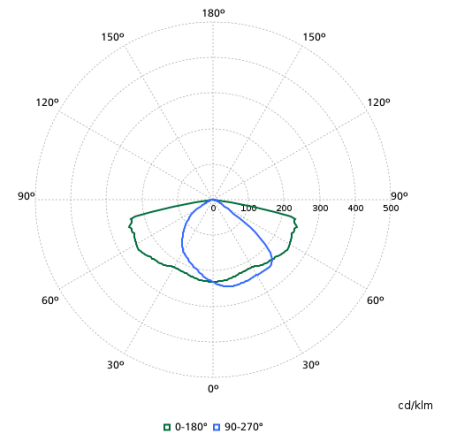

BGP307I - 910925865248

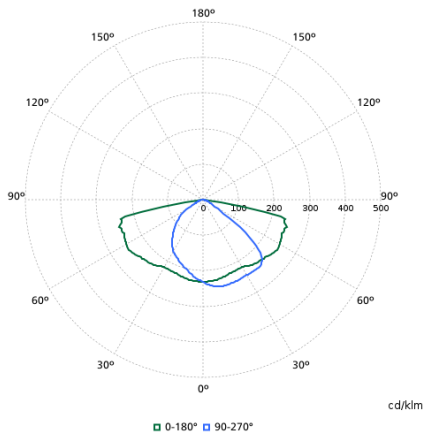

BGP307I - 910925865213

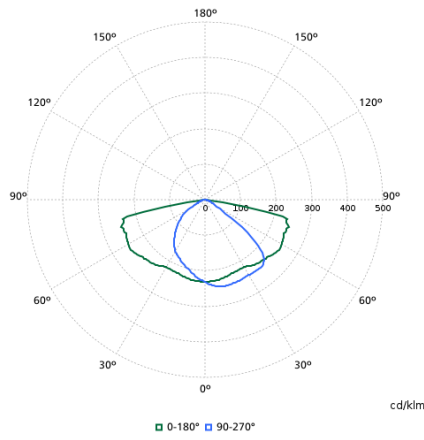

BGP307I - 910925865215

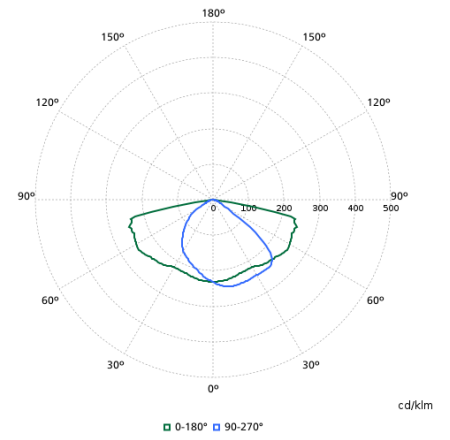

BGP307I - 910925865151

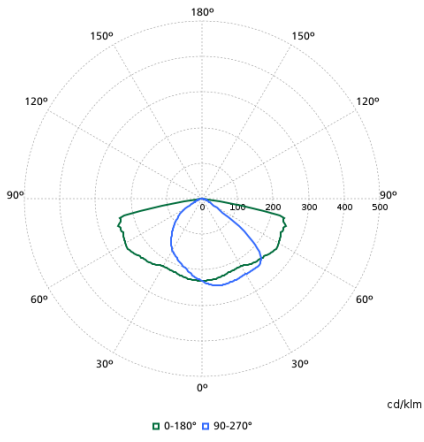

BGP307I - 910925865235

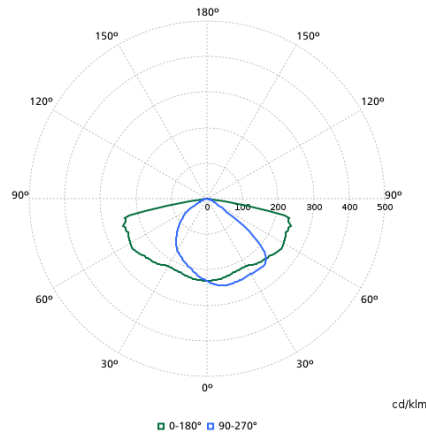

BGP307I - 910925865211

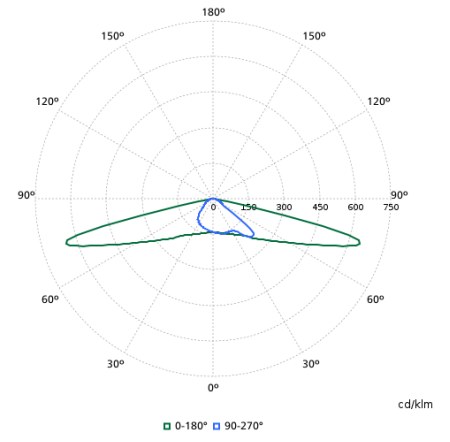

BGP307I - 910925864593

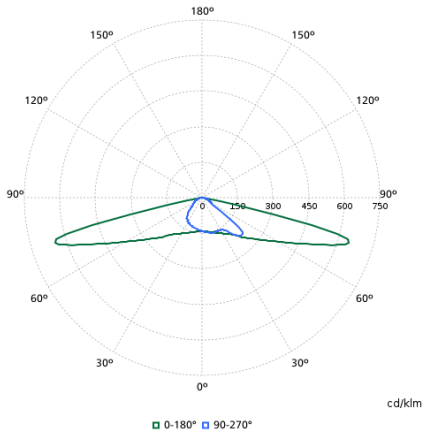

BGP307I - 910925864595

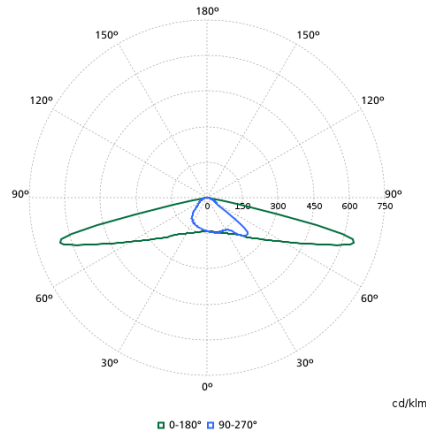

BGP307I - 910925864584

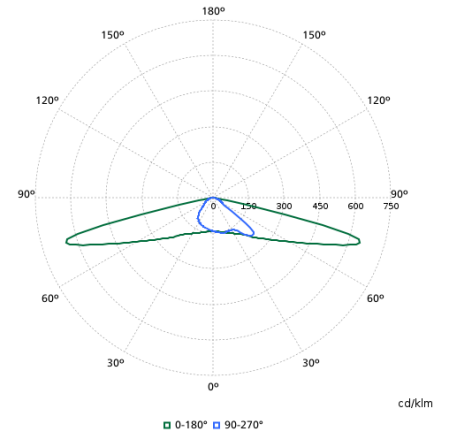

BGP307I - 910925864588

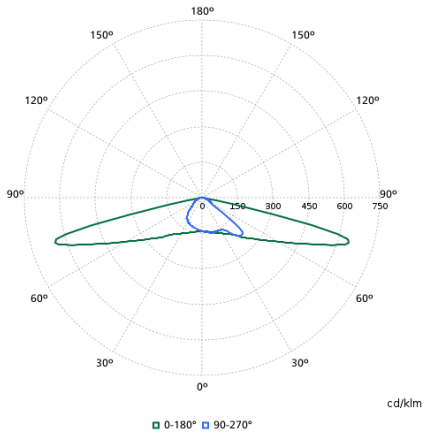

BGP307I - 910925864589

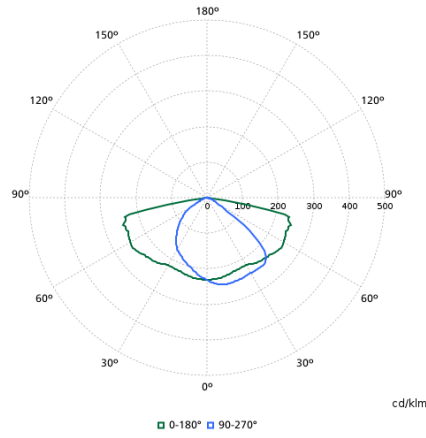

BGP307I - 910925865153

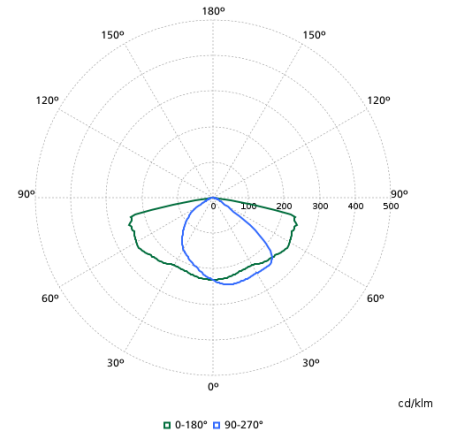

BGP307I - 910925865214

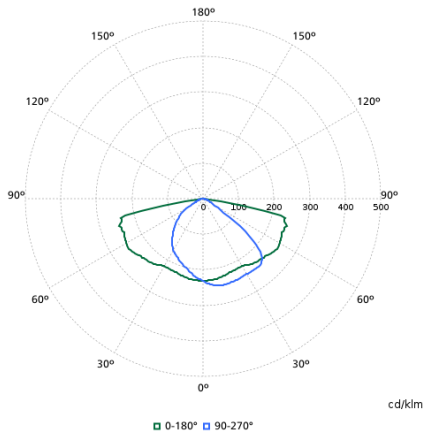

BGP307I - 910925865222

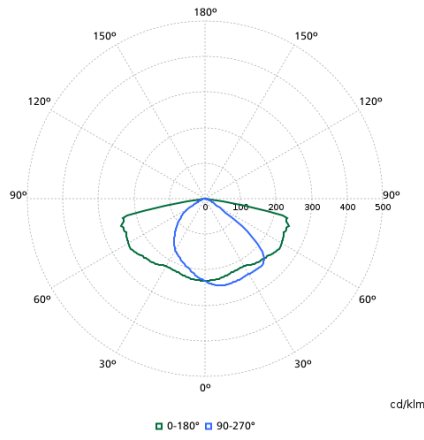

BGP307I - 910925865234

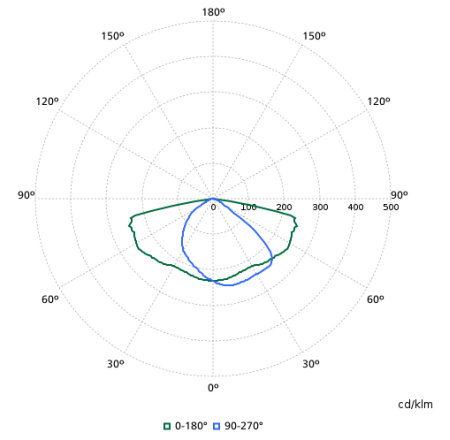

BGP307I - 910925865238

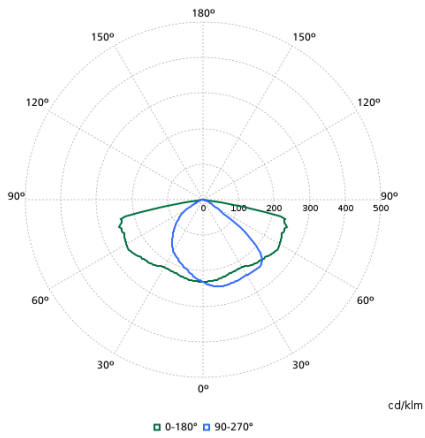

BGP307I - 910925865251

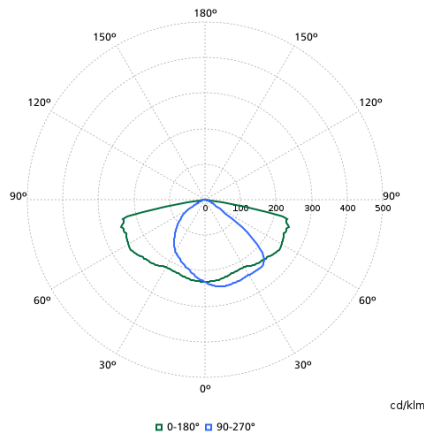

BGP307I - 910925865245

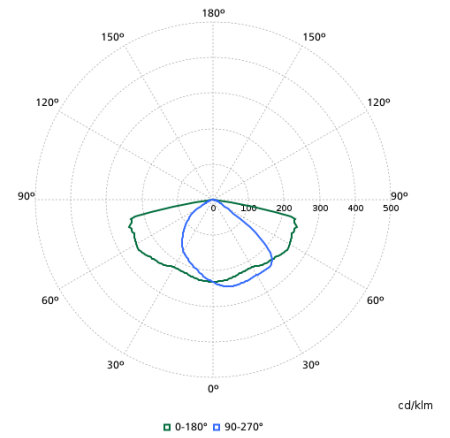

BGP307I - 910925865242