



# Time to upgrade your conventional lighting to LumiStreet gen2

## LumiStreet gen2

Designed for ledification projects, the LumiStreet gen2 is the ideal 1:1 luminaire replacement for municipalities. Thanks to its high efficiency and low initial cost, the LumiStreet gen2 luminaire enables a fast payback and significant savings in terms of energy consumption within a short period of time. The ease of installation and maintenance is enabled by the Philips Service tag and the Philips SR (System Ready) Zhaga socket(s) makes it future-ready, and you can pair this luminaire with lighting control or sensors and software applications such as Interact City. Available with a significant number of different optics and lumen packages that can even be tuned further to fit exact project requirements, LumiStreet gen2 is a true point-to-point replacement solution for conventional or generation 1 LED light sources. The compact luminaire, using high-quality materials is also easy to dismantle and recycle at the end of its lifetime.

### Benefits

- Economical LED alternative to conventional street lights
- Offers high efficiency and energy savings
- Made of high-quality materials for longer lifetime and minimized maintenance

### Features

- Good application coverage thanks to wide range of optics, tunable flux and tiltable spigot
- Easy luminaire identification due to the Service tag
- Future-ready thanks to the SR (System Ready) socket
- High system efficiency with good application coverage
- Luminaire is also equipped with dedicated light recipes that help with: 1) maintaining an optimal ecosystems for bats or 2) preserving a dark night sky and reduce light pollution

# LumiStreet gen2

## Application

- Roads and streets
- Residential streets

## Versions



UniStreet LumiStreet gen2 Nano

LumiStreet/UniStreet gen2 Medium

UniStreet gen2 Medium Solar

LumiStreet/UniStreet gen2 Large

## Dimensional drawing

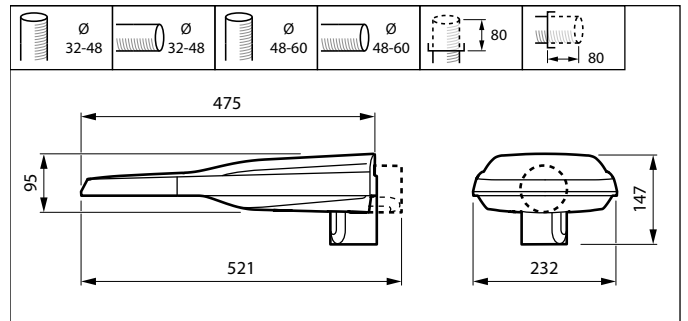
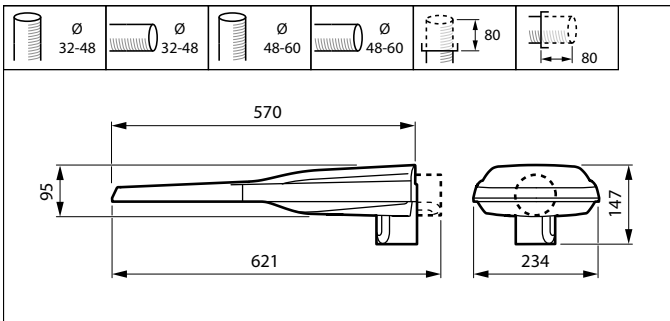
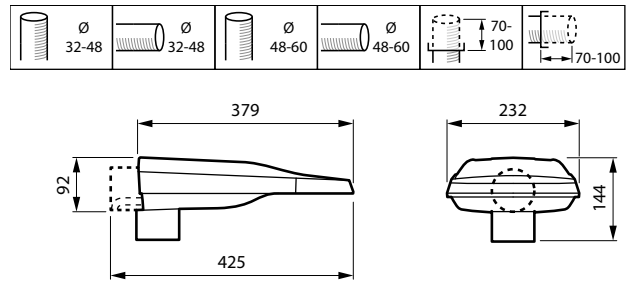
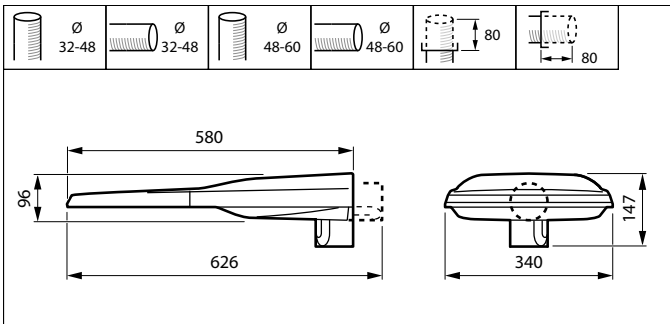

# LumiStreet gen2

## Dimensional drawing

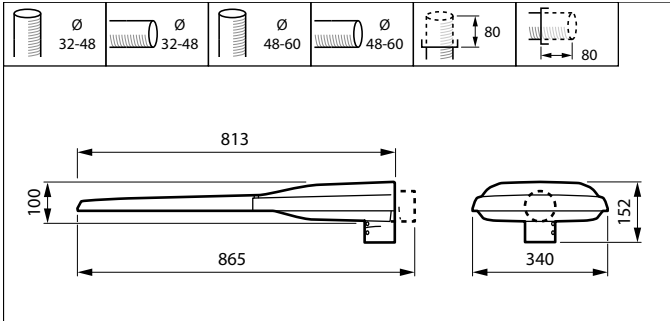

## Product details

UniStreet LumiStreet gen2 Nano  
top side view with Zhaga sockets



UniStreet\_LumiStreet\_gen2



UniStreet LumiStreet gen2 Nano  
profile view

UniStreet gen2 spigot regulation



UniStreet\_LumiStreet\_gen2

UniStreet\_LumiStreet\_gen2



# LumiStreet gen2

## Product details

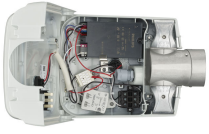

UniStreet LumiStreet gen2 Nano  
gear compartment

UniStreet\_LumiStreet\_gen2



UniStreet\_LumiStreet\_gen2

UniStreet\_LumiStreet\_gen2



UniStreet LumiStreet gen2 Nano  
spigot view

Bottom view for spigot regulation  
and screw



UniStreet LumiStreet gen2 Nano  
spigot view

UniStreet LumiStreet gen2 Nano  
profile view with Zhaga sockets



# LumiStreet gen2

## Product details

UniStreet\_LumiStreet\_gen2



UniStreet LumiStreet gen2 Nano  
top view



UniStreet LumiStreet gen2 Nano  
bottom view



UniStreet LumiStreet gen2 Nano  
bottom view with louvre



UniStreet LumiStreet gen2 Nano  
gear compartment



UniStreet LumiStreet gen2 Nano  
gear compartment



UniStreet\_LumiStreet\_gen2



UniStreet\_LumiStreet\_gen2



## General Information

Driver included Yes

## Light Technical

Color rendering index (CRI) 70

Upward light output ratio 0

## Mechanical and Housing

Optical cover type Flat glass

Ingress protection code IP66

Standard tilt angle side entry 0°

Standard tilt angle posttop 0°

## Approval and Application

CE mark Yes

Flammability mark For mounting on normally flammable surfaces

## General Information

Order Code	Full Product Name	Lamp family code	Light source replaceable	Number of gear units	Service tag
910925868722	BGP390 LED50-1F/740 I DM10 48/60S	LED50	Yes	1 unit	Yes
910925868725	BGP390 LED50-1F/740 II DM10 48/60S	LED50	Yes	1 unit	Yes
910925869154	BGP290 LED50-1F/730 II DM50 D9 48/60S	LED50	Yes	1 unit	Yes
910925866577	BGP292 LED99-4S/740 I DX10 7024 D9 48/60	LED99	Yes	1 unit	Yes
910925866617	BGP292 LED80-4S/740 II DM50 D9 48/60S	LED80	Yes	1 unit	Yes
910925866628	BGP292 LED120-4S/740 II DM50 D9 48/60S	LED120	Yes	1 unit	Yes
910925866639	BGP292 LED120-4S/740 II DM11 48/60S	LED120	Yes	1 unit	Yes
910925866640	BGP292 LED85-4S/740 II DM11 48/60S	LED85	Yes	1 unit	Yes
910925866697	BGP292 LED75-4S/740 I DX10 7024 D9 48/60	LED75	Yes	1 unit	Yes
910925866698	BGP292 LED49-4S/740 I DX10 7024 D9 48/60	LED49	Yes	1 unit	Yes
910925866705	BGP292 LED75-4S/740 I DX10 7024 D9 76S	LED75	Yes	1 unit	Yes
910925866766	BGP292 LED99-4S/740 I DX10 7024 D9 76S	LED99	Yes	1 unit	Yes
910925867781	BGP292 LED70-4S/740 II DM11 48/76S POLE	LED70	Yes	1 unit	Yes
910925868107	BGP292 LED100-4S/730 II DM50 MSP 48/60S	LED100	Yes	1 unit	Yes
910925868108	BGP292 LED100-4S/730 II DM50 48/60S	LED100	Yes	1 unit	Yes
910925869852	BGP292 LED120-1P/740 UE II DM24P D9 48/6	LED240	-	1 unit	Yes
910925870249	BGP392 LED120-1P/740 II DM65P FS 32/76P	LED120	-	1 unit	-
910925870251	BGP392 LED113-1P/730 II DM65P FS 32/76P	LED113	-	1 unit	-
910925866444	BGP293 LED240-4S/740 I DM11 48/60S	LED240	Yes	1 unit	Yes
910925866632	BGP293 LED180-4S/740 II DM50 D9 48/60S	LED180	Yes	1 unit	Yes
910925866904	BGP293 LED120-4S/740 II DM11 CLO S05Z1Z1	LED120	Yes	1 unit	Yes
910925868935	BGP293 LED240-4S/730 II DM32 MSP SRG10 H	LED240	Yes	1 unit	Yes
910925869853	BGP293 LED240-1P/740 UE II DM24P D9 48/6	LED240	-	1 unit	Yes
910925866667	BGP394 LED340-4S/740 II DM11 D9 48/60S P	LED340	Yes	2 units	Yes
910925869854	BGP294 LED340-1P/740 UE II DM24P D9 48/6	LED240	-	1 unit	Yes

Order Code	Full Product Name	Lamp family code	Light source replaceable	Number of gear units	Service tag
910925868105	BGP291 LED51-4S/730 II DM50 MSP 48/60S	LED51	Yes	1 unit	Yes
910925868106	BGP291 LED51-4S/730 II DM50 48/60S	LED51	Yes	1 unit	Yes
910925869851	BGP291 LED50-1P/740 UE II DM24P D9 48/60	LED240	-	1 unit	Yes
910925870248	BGP391 LED82-1P/740 II DM65P FS 32/76P	LED82	-	1 unit	-
910925870250	BGP391 LED78-1P/730 II DM65P FS 32/76P	LED79	-	1 unit	-

Light Technical (1/2)

Order Code	Full Product Name	Luminaire light beam spread	Light source color	Correlated Color	
				Temperature (Nom)	Luminous Flux
910925868722	BGP390 LED50-1F/740 I DM10 48/60S	157° - 33° x 55°	740 neutral white	4000 K	4,100 lm
910925868725	BGP390 LED50-1F/740 II DM10 48/60S	157° - 33° x 55°	740 neutral white	4000 K	4,100 lm
910925869154	BGP290 LED50-1F/730 II DM50 D9 48/60S	154° - 31° x 54°	730 warm white	3000 K	4,000 lm
910925865677	BGP292 LED99-4S/740 I DX10 7024 D9 48/60	150° - 43° x 67°	740 neutral white	4000 K	8,600 lm
910925866617	BGP292 LED80-4S/740 II DM50 D9 48/60S	154° - 31° x 54°	740 neutral white	4000 K	6,960 lm
910925866628	BGP292 LED120-4S/740 II DM50 D9 48/60S	154° - 31° x 54°	740 neutral white	4000 K	10,200 lm
910925866639	BGP292 LED120-4S/740 II DM11 48/60S	160° - 42° x 54°	740 neutral white	4000 K	10,200 lm
910925866640	BGP292 LED85-4S/740 II DM11 48/60S	160° - 42° x 54°	740 neutral white	4000 K	7,482 lm
910925866697	BGP292 LED75-4S/740 I DX10 7024 D9 48/60	150° - 43° x 67°	740 neutral white	4000 K	6,612 lm
910925866698	BGP292 LED49-4S/740 I DX10 7024 D9 48/60	150° - 43° x 67°	740 neutral white	4000 K	4,263 lm
910925866705	BGP292 LED75-4S/740 I DX10 7024 D9 76S	150° - 43° x 67°	740 neutral white	4000 K	6,612 lm

Order Code	Full Product Name	Luminaire light beam spread	Light source color	Correlated Color	
				Temperature (Nom)	Luminous Flux
910925866766	BGP292 LED99-4S/740 I DX10 7024 D9 76S	150° - 43° x 67°	740 neutral white	4000 K	8,600 lm
910925867781	BGP292 LED70-4S/740 II DM11 48/76S POLE	160° - 42° x 54°	740 neutral white	4000 K	6,090 lm
910925868107	BGP292 LED100-4S/730 II DM50 MSP 48/60S	154° - 31° x 54°	730 warm white	3000 K	8,600 lm
910925868108	BGP292 LED100-4S/730 II DM50 48/60S	154° - 31° x 54°	730 warm white	3000 K	8,600 lm
910925869852	BGP292 LED120-1P/740 O UE II DM24P D9 48/6	160° - 42° x 54°	740 neutral white	4000 K	10,320 lm
910925870249	BGP392 LED120-1P/740 II DM65P FS 32/76P	160° - 42° x 54°	740 neutral white	4000 K	10,560 lm
910925870251	BGP392 LED113-1P/730 II DM65P FS 32/76P	160° - 42° x 54°	730 warm white	3000 K	9,280 lm
910925866444	BGP293 LED240-4S/740 I DM11 48/60S	160° - 42° x 54°	740 neutral white	4000 K	20,160 lm
910925866632	BGP293 LED180-4S/740 II DM50 D9 48/60S	154° - 31° x 54°	740 neutral white	4000 K	15,300 lm
910925866904	BGP293 LED120-4S/740 II DM11 CLO S05Z1Z1	160° - 42° x 54°	740 neutral white	4000 K	10,005 lm
910925868935	BGP293 LED240-4S/730 II DM32 MSP SRG10 H	149° - 10° x 57°	730 warm white	3000 K	20,400 lm

## LumiStreet gen2

Order Code	Full Product Name	Luminaire light beam spread	Light source color	Correlated Color	
				Temperature (Nom)	Luminous Flux
910925869853	BGP293 LED240-1P/74 0 UE II DM24P D9 48/6	160° - 42° x 54°	740 neutral white	4000 K	20,400 lm
910925866667	BGP394 LED340-4S/740 II DM11 D9 48/60S P	160° - 42° x 54°	740 neutral white	4000 K	29,240 lm
910925869854	BGP294 LED340-1P/74 0 UE II DM24P D9 48/6	160° - 42° x 54°	740 neutral white	4000 K	28,560 lm
910925868105	BGP291 LED51-4S/730 II DM50 MSP 48/60S	154° - 31° x 54°	730 warm white	3000 K	4,524 lm

Order Code	Full Product Name	Luminaire light beam spread	Light source color	Correlated Color	
				Temperature (Nom)	Luminous Flux
910925868106	BGP291 LED51-4S/730 II DM50 48/60S	154° - 31° x 54°	730 warm white	3000 K	4,524 lm
910925869851	BGP291 LED50-1P/740 UE II DM24P D9 48/60	160° - 42° x 54°	740 neutral white	4000 K	4,350 lm
910925870248	BGP391 LED82-1P/740 II DM65P FS 32/76P	160° - 42° x 54°	740 neutral white	4000 K	6,710 lm
910925870250	BGP391 LED78-1P/730 II DM65P FS 32/76P	160° - 42° x 54°	730 warm white	3000 K	6,210 lm

### Light Technical (2/2)

Order Code	Full Product Name	Optic type outdoor
910925868722	BGP390 LED50-1F/740 I DM10 48/60S	Distribution medium 10
910925868725	BGP390 LED50-1F/740 II DM10 48/60S	Distribution medium 10
910925869154	BGP290 LED50-1F/730 II DM50 D9 48/60S	Distribution medium 50
910925865677	BGP292 LED99-4S/740 I DX10 7024 D9 48/60	Distribution extra wide 10
910925866617	BGP292 LED80-4S/740 II DM50 D9 48/60S	Distribution medium 50
910925866628	BGP292 LED120-4S/740 II DM50 D9 48/60S	Distribution medium 50
910925866639	BGP292 LED120-4S/740 II DM11 48/60S	Distribution medium 11
910925866640	BGP292 LED85-4S/740 II DM11 48/60S	Distribution medium 11
910925866697	BGP292 LED75-4S/740 I DX10 7024 D9 48/60	Distribution extra wide 10
910925866698	BGP292 LED49-4S/740 I DX10 7024 D9 48/60	Distribution extra wide 10
910925866705	BGP292 LED75-4S/740 I DX10 7024 D9 76S	Distribution extra wide 10
910925866766	BGP292 LED99-4S/740 I DX10 7024 D9 76S	Distribution extra wide 10
910925867781	BGP292 LED70-4S/740 II DM11 48/76S POLE	Distribution medium 11
910925868107	BGP292 LED100-4S/730 II DM50 MSP 48/60S	Distribution medium 50
910925868108	BGP292 LED100-4S/730 II DM50 48/60S	Distribution medium 50
910925869852	BGP292 LED120-1P/740 UE II DM24P D9 48/6	Distribution medium 32
910925870249	BGP392 LED120-1P/740 II DM65P FS 32/76P	Distribution medium version 65 Performance (for 5050)

Order Code	Full Product Name	Optic type outdoor
910925870251	BGP392 LED113-1P/730 II DM65P FS 32/76P	Distribution medium version 65 Performance (for 5050)
910925866444	BGP293 LED240-4S/740 I DM11 48/60S	Distribution medium 11
910925866632	BGP293 LED180-4S/740 II DM50 D9 48/60S	Distribution medium 50
910925866904	BGP293 LED120-4S/740 II DM11 CLO S05Z1Z1	Distribution medium 11
910925868935	BGP293 LED240-4S/730 II DM32 MSP SRG10 H	Distribution medium 32
910925869853	BGP293 LED240-1P/740 UE II DM24P D9 48/6	Distribution medium 32
910925866667	BGP394 LED340-4S/740 II DM11 D9 48/60S P	Distribution medium 11
910925869854	BGP294 LED340-1P/740 UE II DM24P D9 48/6	Distribution medium 32
910925868105	BGP291 LED51-4S/730 II DM50 MSP 48/60S	Distribution medium 50
910925868106	BGP291 LED51-4S/730 II DM50 48/60S	Distribution medium 50
910925869851	BGP291 LED50-1P/740 UE II DM24P D9 48/60	Distribution medium 32
910925870248	BGP391 LED82-1P/740 II DM65P FS 32/76P	Distribution medium version 65 Performance (for 5050)
910925870250	BGP391 LED78-1P/730 II DM65P FS 32/76P	Distribution medium version 65 Performance (for 5050)

### Operating and Electrical

## LumiStreet gen2

Order Code	Full Product Name	Power Consumption	Surge Protection (Common/Differential)
910925868722	BGP390 LED50-1F/740 I DM10 48/60S	31 W	Surge protection level until 6 kV differential mode and 8 kV common mode
910925868725	BGP390 LED50-1F/740 II DM10 48/60S	31 W	Surge protection level until 6 kV differential mode and 8 kV common mode
910925869154	BGP290 LED50-1F/730 II DM50 D9 48/60S	32.5 W	Surge protection level until 6 kV differential mode and 8 kV common mode
910925865677	BGP292 LED99-4S/740 I DX10 7024 D9 48/60	60 W	Surge protection level until 6 kV differential mode and 8 kV common mode
910925866617	BGP292 LED80-4S/740 II DM50 D9 48/60S	47 W	Surge protection level until 6 kV differential mode and 8 kV common mode
910925866628	BGP292 LED120-4S/740 II DM50 D9 48/60S	70 W	Surge protection level until 6 kV differential mode and 8 kV common mode
910925866639	BGP292 LED120-4S/740 II DM11 48/60S	70 W	Surge protection level until 6 kV differential mode and 8 kV common mode
910925866640	BGP292 LED85-4S/740 II DM11 48/60S	50 W	Surge protection level until 6 kV differential mode and 8 kV common mode
910925866697	BGP292 LED75-4S/740 I DX10 7024 D9 48/60	44 W	Surge protection level until 6 kV differential mode and 8 kV common mode
910925866698	BGP292 LED49-4S/740 I DX10 7024 D9 48/60	29 W	Surge protection level until 6 kV differential mode and 8 kV common mode
910925866705	BGP292 LED75-4S/740 I DX10 7024 D9 76S	44 W	Surge protection level until 6 kV differential mode and 8 kV common mode
910925866766	BGP292 LED99-4S/740 I DX10 7024 D9 76S	60 W	Surge protection level until 6 kV differential mode and 8 kV common mode
910925867781	BGP292 LED70-4S/740 II DM11 48/76S POLE	40.5 W	Surge protection level until 6 kV differential

Order Code	Full Product Name	Power Consumption	Surge Protection (Common/Differential)
910925868107	BGP292 LED100-4S/730 II DM50 MSP 48/60S	61 W	Surge protection level until 6 kV differential mode and 8 kV common mode
910925868108	BGP292 LED100-4S/730 II DM50 48/60S	61 W	Surge protection level until 6 kV differential mode and 8 kV common mode
910925869852	BGP292 LED120-1P/740 UE II DM24P D9 48/6	60 W	Surge protection level until 6 kV differential mode and 8 kV common mode
910925870249	BGP392 LED120-1P/740 II DM65P FS 32/76P	61 W	Surge protection level until 6 kV differential mode and 8 kV common mode
910925870251	BGP392 LED113-1P/730 II DM65P FS 32/76P	56 W	Surge protection level until 6 kV differential mode and 8 kV common mode
910925866444	BGP293 LED240-4S/740 I DM11 48/60S	138 W	Surge protection level until 6 kV differential mode and 8 kV common mode
910925866632	BGP293 LED180-4S/740 II DM50 D9 48/60S	104 W	Surge protection level until 6 kV differential mode and 8 kV common mode
910925866904	BGP293 LED120-4S/740 II DM11 CLO S05Z1Z1	67 W	Surge protection level until 6 kV differential mode and 8 kV common mode
910925868935	BGP293 LED240-4S/730 II DM32 MSP SRG10 H	154 W	Surge protection level until 10 kV differential mode and 10 kV common mode
910925869853	BGP293 LED240-1P/740 UE II DM24P D9 48/6	118 W	Surge protection level until 6 kV differential mode and 8 kV common mode
910925866667	BGP394 LED340-4S/740 II DM11 D9 48/60S P	186 W	Surge protection level until 6 kV differential mode and 8 kV common mode
910925869854	BGP294 LED340-1P/740 UE II DM24P D9 48/6	168 W	Surge protection level until 6 kV differential mode and 8 kV common mode

## LumiStreet gen2

Order Code	Full Product Name	Power	Surge Protection
		Consumption	(Common/Differential)
910925868105	BGP291 LED51-4S/730 II DM50 MSP 48/60S	32.5 W	Surge protection level until 6 kV differential mode and 8 kV common mode
910925868106	BGP291 LED51-4S/730 II DM50 48/60S	32.5 W	Surge protection level until 6 kV differential mode and 8 kV common mode
910925869851	BGP291 LED50-1P/740 UE II DM24P D9 48/60	26 W	Surge protection level until 6 kV differential

Order Code	Full Product Name	Power	Surge Protection
		Consumption	(Common/Differential)
910925870248	BGP391 LED82-1P/740 II DM65P FS 32/76P	40 W	Surge protection level until 6 kV differential mode and 8 kV common mode
910925870250	BGP391 LED78-1P/730 II DM65P FS 32/76P	40 W	Surge protection level until 6 kV differential mode and 8 kV common mode

### Controls and Dimming

Order Code	Full Product Name	Dimmable	Maximum dim
			level
910925868722	BGP390 LED50-1F/740 I DM10 48/60S	Yes	0% (digital)
910925868725	BGP390 LED50-1F/740 II DM10 48/60S	Yes	0% (digital)
910925869154	BGP290 LED50-1F/730 II DM50 D9 48/60S	Yes	0% (digital)
910925865677	BGP292 LED99-4S/740 I DX10 7024 D9 48/60	Yes	0% (digital)
910925866617	BGP292 LED80-4S/740 II DM50 D9 48/60S	No	0% (digital)
910925866628	BGP292 LED120-4S/740 II DM50 D9 48/60S	No	0% (digital)
910925866639	BGP292 LED120-4S/740 II DM11 48/60S	No	0% (digital)
910925866640	BGP292 LED85-4S/740 II DM11 48/60S	No	0% (digital)
910925866697	BGP292 LED75-4S/740 I DX10 7024 D9 48/60	Yes	0% (digital)
910925866698	BGP292 LED49-4S/740 I DX10 7024 D9 48/60	Yes	0% (digital)
910925866705	BGP292 LED75-4S/740 I DX10 7024 D9 76S	Yes	0% (digital)
910925866766	BGP292 LED99-4S/740 I DX10 7024 D9 76S	Yes	0% (digital)
910925867781	BGP292 LED70-4S/740 II DM11 48/76S POLE	No	0% (digital)
910925868107	BGP292 LED100-4S/730 II DM50 MSP 48/60S	No	Programmable
910925868108	BGP292 LED100-4S/730 II DM50 48/60S	No	Programmable

Order Code	Full Product Name	Dimmable	Maximum dim
			level
910925869852	BGP292 LED120-1P/740 UE II DM24P D9 48/6	Yes	0% (digital)
910925870249	BGP392 LED120-1P/740 II DM65P FS 32/76P	Yes	0% (digital)
910925870251	BGP392 LED113-1P/730 II DM65P FS 32/76P	Yes	0% (digital)
910925866444	BGP293 LED240-4S/740 I DM11 48/60S	No	0% (digital)
910925866632	BGP293 LED180-4S/740 II DM50 D9 48/60S	Yes	0% (digital)
910925866904	BGP293 LED120-4S/740 II DM11 CLO S05Z1Z1	No	0% (digital)
910925868935	BGP293 LED240-4S/730 II DM32 MSP SRG10 H	No	0% (digital)
910925869853	BGP293 LED240-1P/740 UE II DM24P D9 48/6	Yes	0% (digital)
910925866667	BGP394 LED340-4S/740 II DM11 D9 48/60S P	No	0% (digital)
910925869854	BGP294 LED340-1P/740 UE II DM24P D9 48/6	Yes	0% (digital)
910925868105	BGP291 LED51-4S/730 II DM50 MSP 48/60S	No	Programmable
910925868106	BGP291 LED51-4S/730 II DM50 48/60S	No	Programmable
910925869851	BGP291 LED50-1P/740 UE II DM24P D9 48/60	Yes	0% (digital)
910925870248	BGP391 LED82-1P/740 II DM65P FS 32/76P	Yes	0% (digital)
910925870250	BGP391 LED78-1P/730 II DM65P FS 32/76P	Yes	0% (digital)

### Mechanical and Housing

Order Code	Full Product Name	Housing Color	Mech. impact protection code
910925868722	BGP390 LED50-1F/740 I DM10 48/60S	Gray	IK08
910925868725	BGP390 LED50-1F/740 II DM10 48/60S	Gray	IK08
910925869154	BGP290 LED50-1F/730 II DM50 D9 48/60S	Gray	IK08
910925865677	BGP292 LED99-4S/740 I DX10 7024 D9 48/60	Gray	IK09
910925866617	BGP292 LED80-4S/740 II DM50 D9 48/60S	Gray	IK09
910925866628	BGP292 LED120-4S/740 II DM50 D9 48/60S	Gray	IK09
910925866639	BGP292 LED120-4S/740 II DM11 48/60S	Gray	IK09
910925866640	BGP292 LED85-4S/740 II DM11 48/60S	Gray	IK09
910925866697	BGP292 LED75-4S/740 I DX10 7024 D9 48/60	Gray	IK09
910925866698	BGP292 LED49-4S/740 I DX10 7024 D9 48/60	Gray	IK09
910925866705	BGP292 LED75-4S/740 I DX10 7024 D9 76S	Gray	IK09
910925866766	BGP292 LED99-4S/740 I DX10 7024 D9 76S	Gray	IK09
910925867781	BGP292 LED70-4S/740 II DM11 48/76S POLE	Gray	IK09
910925868107	BGP292 LED100-4S/730 II DM50 MSP 48/60S	Gray	IK09
910925868108	BGP292 LED100-4S/730 II DM50 48/60S	Gray	IK09
910925869852	BGP292 LED120-1P/740 UE II DM24P D9 48/6	Grey	IK08

Order Code	Full Product Name	Housing Color	Mech. impact protection code
910925870249	BGP392 LED120-1P/740 II DM65P FS 32/76P	Grey	IK09
910925870251	BGP392 LED113-1P/730 II DM65P FS 32/76P	Grey	IK09
910925866444	BGP293 LED240-4S/740 I DM11 48/60S	Gray	IK09
910925866632	BGP293 LED180-4S/740 II DM50 D9 48/60S	Gray	IK09
910925866904	BGP293 LED120-4S/740 II DM11 CLO S05Z1Z1	Gray	IK09
910925868935	BGP293 LED240-4S/730 II DM32 MSP SRG10 H	Grey	IK09
910925869853	BGP293 LED240-1P/740 UE II DM24P D9 48/6	Grey	IK08
910925866667	BGP394 LED340-4S/740 II DM11 D9 48/60S P	Gray	IK09
910925869854	BGP294 LED340-1P/740 UE II DM24P D9 48/6	Grey	IK08
910925868105	BGP291 LED51-4S/730 II DM50 MSP 48/60S	Gray	IK09
910925868106	BGP291 LED51-4S/730 II DM50 48/60S	Gray	IK09
910925869851	BGP291 LED50-1P/740 UE II DM24P D9 48/60	Grey	IK08
910925870248	BGP391 LED82-1P/740 II DM65P FS 32/76P	Grey	IK09
910925870250	BGP391 LED78-1P/730 II DM65P FS 32/76P	Grey	IK09

## Over Time Performance (IEC Compliant)

Order Code	Full Product Name	Driver failure rate at 5000 h
910925868722	BGP390 LED50-1F/740 I DM10 48/60S	-
910925868725	BGP390 LED50-1F/740 II DM10 48/60S	-
910925869154	BGP290 LED50-1F/730 II DM50 D9 48/60S	-
910925865677	BGP292 LED99-4S/740 I DX10 7024 D9 48/60	0.5 %
910925866617	BGP292 LED80-4S/740 II DM50 D9 48/60S	0.5 %
910925866628	BGP292 LED120-4S/740 II DM50 D9 48/60S	0.5 %
910925866639	BGP292 LED120-4S/740 II DM11 48/60S	0.5 %
910925866640	BGP292 LED85-4S/740 II DM11 48/60S	0.5 %
910925866697	BGP292 LED75-4S/740 I DX10 7024 D9 48/60	0.5 %
910925866698	BGP292 LED49-4S/740 I DX10 7024 D9 48/60	0.5 %
910925866705	BGP292 LED75-4S/740 I DX10 7024 D9 76S	0.5 %
910925866766	BGP292 LED99-4S/740 I DX10 7024 D9 76S	0.5 %
910925867781	BGP292 LED70-4S/740 II DM11 48/76S POLE	0.5 %
910925868107	BGP292 LED100-4S/730 II DM50 MSP 48/60S	-
910925868108	BGP292 LED100-4S/730 II DM50 48/60S	-

Order Code	Full Product Name	Driver failure rate at 5000 h
910925869852	BGP292 LED120-1P/740 UE II DM24P D9 48/6	-
910925870249	BGP392 LED120-1P/740 II DM65P FS 32/76P	-
910925870251	BGP392 LED113-1P/730 II DM65P FS 32/76P	-
910925866444	BGP293 LED240-4S/740 I DM11 48/60S	0.5 %
910925866632	BGP293 LED180-4S/740 II DM50 D9 48/60S	0.5 %
910925866904	BGP293 LED120-4S/740 II DM11 CLO S05Z1Z1	0.5 %
910925868935	BGP293 LED240-4S/730 II DM32 MSP SRG10 H	-
910925869853	BGP293 LED240-1P/740 UE II DM24P D9 48/6	-
910925866667	BGP394 LED340-4S/740 II DM11 D9 48/60S P	-
910925869854	BGP294 LED340-1P/740 UE II DM24P D9 48/6	-
910925868105	BGP291 LED51-4S/730 II DM50 MSP 48/60S	-
910925868106	BGP291 LED51-4S/730 II DM50 48/60S	-
910925869851	BGP291 LED50-1P/740 UE II DM24P D9 48/60	-
910925870248	BGP391 LED82-1P/740 II DM65P FS 32/76P	-
910925870250	BGP391 LED78-1P/730 II DM65P FS 32/76P	-

## Product Data

Order Code	Full Product Name	Product family code
910925868722	BGP390 LED50-1F/740 I DM10 48/60S	BGP390
910925868725	BGP390 LED50-1F/740 II DM10 48/60S	BGP390
910925869154	BGP290 LED50-1F/730 II DM50 D9 48/60S	BGP290
910925865677	BGP292 LED99-4S/740 I DX10 7024 D9 48/60	BGP292
910925866617	BGP292 LED80-4S/740 II DM50 D9 48/60S	BGP292
910925866628	BGP292 LED120-4S/740 II DM50 D9 48/60S	BGP292
910925866639	BGP292 LED120-4S/740 II DM11 48/60S	BGP292
910925866640	BGP292 LED85-4S/740 II DM11 48/60S	BGP292
910925866697	BGP292 LED75-4S/740 I DX10 7024 D9 48/60	BGP292
910925866698	BGP292 LED49-4S/740 I DX10 7024 D9 48/60	BGP292
910925866705	BGP292 LED75-4S/740 I DX10 7024 D9 76S	BGP292
910925866766	BGP292 LED99-4S/740 I DX10 7024 D9 76S	BGP292
910925867781	BGP292 LED70-4S/740 II DM11 48/76S POLE	BGP292
910925868107	BGP292 LED100-4S/730 II DM50 MSP 48/60S	BGP292
910925868108	BGP292 LED100-4S/730 II DM50 48/60S	BGP292

Order Code	Full Product Name	Product family code
910925869852	BGP292 LED120-1P/740 UE II DM24P D9 48/6	BGP292
910925870249	BGP392 LED120-1P/740 II DM65P FS 32/76P	BGP392
910925870251	BGP392 LED113-1P/730 II DM65P FS 32/76P	BGP392
910925866444	BGP293 LED240-4S/740 I DM11 48/60S	BGP293
910925866632	BGP293 LED180-4S/740 II DM50 D9 48/60S	BGP293
910925866904	BGP293 LED120-4S/740 II DM11 CLO S05Z1Z1	BGP293
910925868935	BGP293 LED240-4S/730 II DM32 MSP SRG10 H	BGP293
910925869853	BGP293 LED240-1P/740 UE II DM24P D9 48/6	BGP293
910925866667	BGP394 LED340-4S/740 II DM11 D9 48/60S P	BGP394
910925869854	BGP294 LED340-1P/740 UE II DM24P D9 48/6	BGP294
910925868105	BGP291 LED51-4S/730 II DM50 MSP 48/60S	BGP291
910925868106	BGP291 LED51-4S/730 II DM50 48/60S	BGP291
910925869851	BGP291 LED50-1P/740 UE II DM24P D9 48/60	BGP291
910925870248	BGP391 LED82-1P/740 II DM65P FS 32/76P	BGP391
910925870250	BGP391 LED78-1P/730 II DM65P FS 32/76P	BGP391

## Polar Wide Diagrams

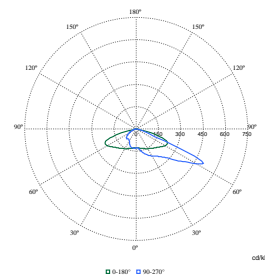
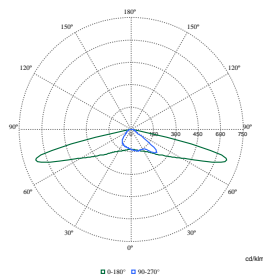
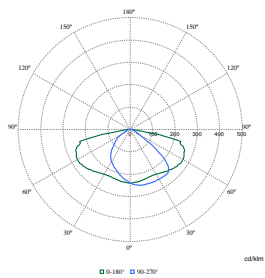

**Polar Normal (separate) - BGP2831 -**  
910925866444

**Polar Normal (separate) - BGP2821 -**  
910925866628

**Polar Normal (separate) - BGP2821 -**  
910925866697

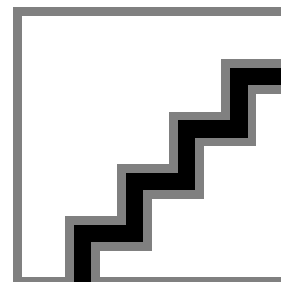
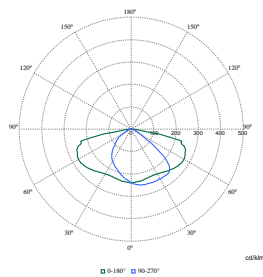
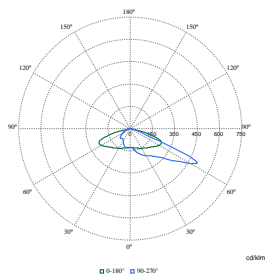

**Polar Normal (separate) - BGP2821 -**  
910925866698

**Polar Normal (separate) - BGP2841 -**  
910925866667

**Polar Normal (separate) - BGP2801 -**  
910925868722

Polar Wide Diagrams

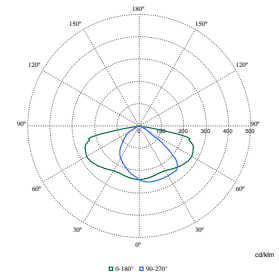
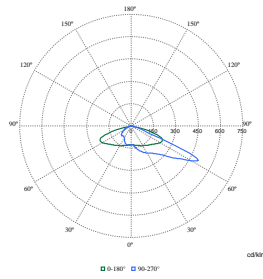
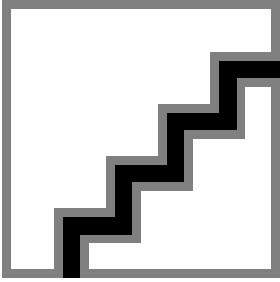

Polar Normal (separate) - BGP2801 - 910925869154

Polar Normal (separate) - BGP2821 - 910925865677

Polar Normal (separate) - BGP2821 - 910925866443

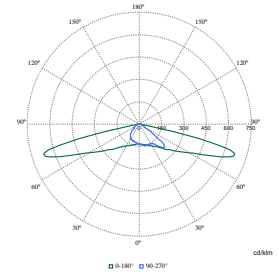
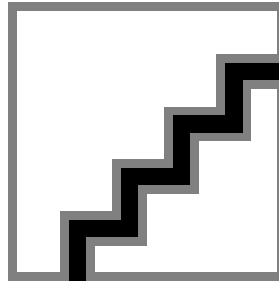
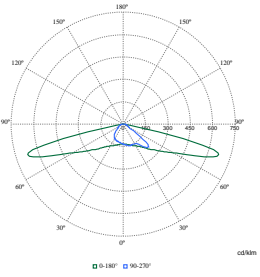

Polar Normal (separate) - BGP2821 - 910925866617

Polar Normal (separate) - BGP2821 - 910925866642

Polar Normal (separate) - BGP2831 - 910925866632

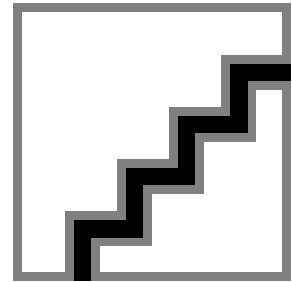
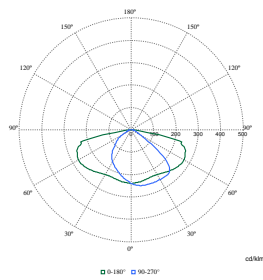
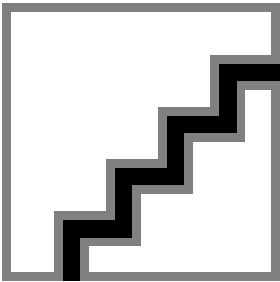

Polar Normal (separate) - BGP2831 - 910925866904

Polar Normal (separate) - BGP2821 - 910925867781

Polar Normal (separate) - BGP2831 - 910925868935

Polar Wide Diagrams

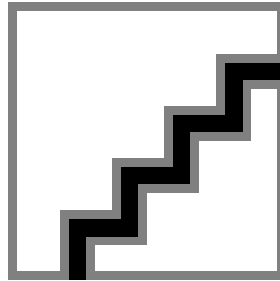
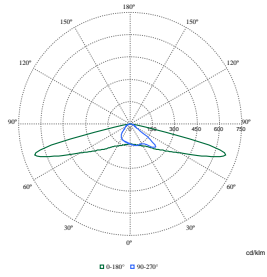

Polar Normal (separate) - BGP2811 - 910925868105

Polar Normal (separate) - BGP2821 - 910925868107

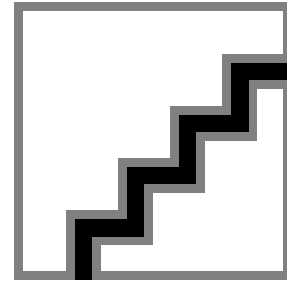

Polar Normal (separate) - BGP2831 - 910925869853

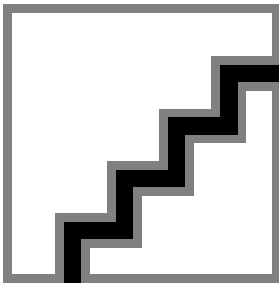

Polar Normal (separate) - BGP2841 - 910925869854

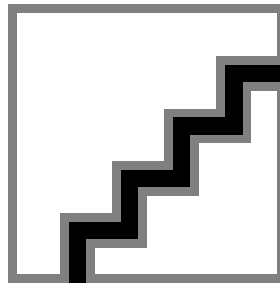

Polar Normal (separate) - BGP2821 - 910925869852

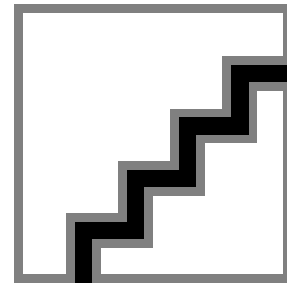

Polar Normal (separate) - BGP2811 - 910925869851

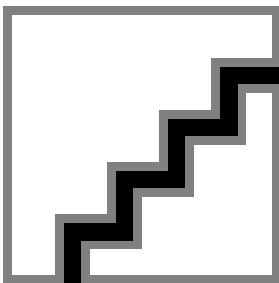

Polar Normal (separate) - null - 910925870248

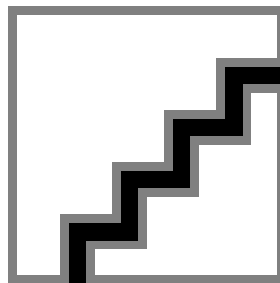

Polar Normal (separate) - null - 910925870251

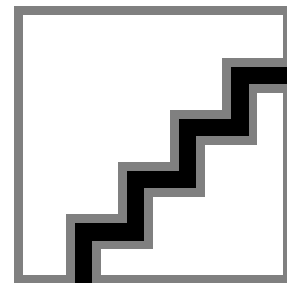

Polar Normal (separate) - null - 910925870250

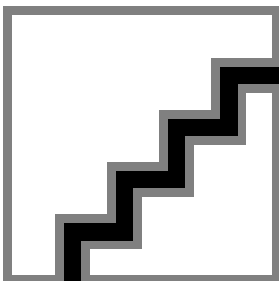

Polar Normal (separate) - null - 910925870249

