



TownGuide Performer

BDP100













TownGuide Performer – flexible, modern designs for every application need

The TownGuide Performer family consists of six recognizable, yet modern shapes: Flat Cone, Bowl, Classic Cone, Classic T, T and Tzero. Each luminaire has the option of a clear (PCC), translucent (PCTR) or frosted (PCF) bowl (except Tzero, which is only available with a clear bowl). With an extensive range of lumen packages, neutral white or warm white LED lights sources, and a range of dedicated optics for lower mounting heights, it's easy to select the version that best suits the specific requirements of your project. All this combined with a long life expectancy of 100,000 operating hours. In addition, TownGuide Performer has a variety of control system options that can make this luminaire an integral part of smart energy-reduction programs. This includes LumiStep, DynaDimmer, and LineSwitch stand-alone dim control, and Coded Mains

group control, right up to seamless remote connectivity with Interact lighting management software. Installation is easy. Thanks to the bayonet whistle connector with integrated gland located in the spigot, there's no need to open the luminaire for installation. The Signify Service tag app offers direct access to all relevant data, ensuring maintenance is easy too. We have made every effort to make the Total Cost of Ownership (TCO) of the luminaire as attractive as possible. And as TownGuide Performer is a dedicated LED luminaire, compatible with a variety of control systems, there are significant energy and maintenance cost savings compared with conventional lighting.

Benefits

- Choice of LED light sources, light colors (2700K, 3000K, 4000K) and optics
- Significant energy and carbon savings compared to HPL mercury, SON-T and PL-L compact fluorescent lamps (up to 80% with CLO and/or dimming options)
- Minimum Total Cost of Ownership
- Long lifetime: 100,000 hours from L80 up to L98 (depending on configuration and light color)
- Easy installation: no need to open luminaire with bayonet whistle connector

Applications

- Residential areas: residential streets, cycle paths and footpaths, roundabouts, squares, parks and playgrounds, parking areas
- City centers: side streets, squares, parks and playgrounds, cycle paths and footpaths, parking areas, roundabouts, shopping and pedestrian areas

Versions

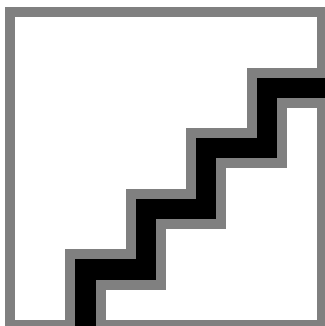

TownGuide

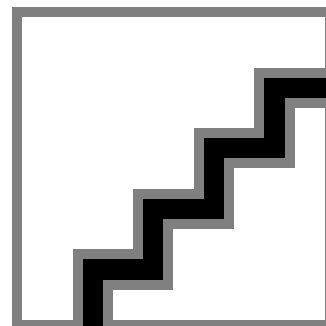

TownGuide

- Area and Transportation: industrial areas, parking areas, petrol stations, airports, harbors, public transport areas
- Sports: parking areas, connecting footpaths

Features

- Six designs that blend in with, and enhance, their surroundings
- New installations or one-to-one replacements
- Dedicated lumen packages (1,200 to 12,000 lm)
- 3 bowl finishes: clear (highest performance), frosted (smooth atmosphere), translucent (enhanced visual comfort)
- 5-year standard warranty, extended warranties or lifecycle services available
- Service tag for easy installation and maintenance.

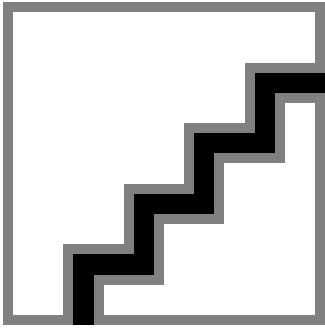

TownGuide

OPPR BDP100i 0001



OPPR BDP100i 0003

BDP101 TownGuide Performer Bowl, frosted



OPPR BDP100i 0005

BDP102 TownGuide Performer Classic cone, clear



OPPR BDP100i 0011

OPPR BDP100i 0015



BDP104 TownGuide Performer T, clear

TownGuide

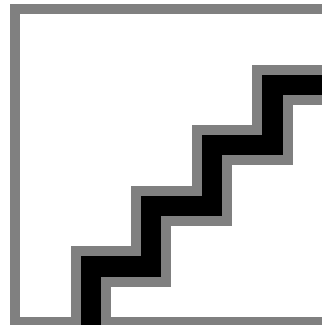

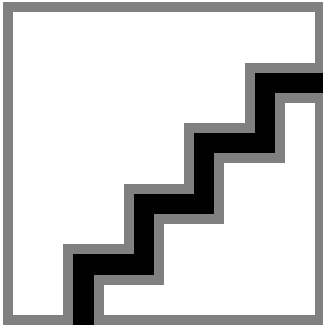

TownGuide

Dimensional drawing

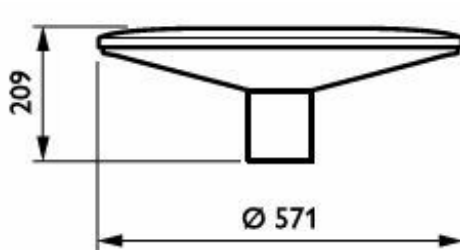
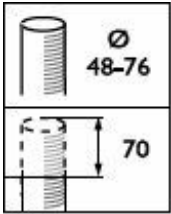

TOWNGUIDE PERF FLAT CONE - LED module 4000 lm

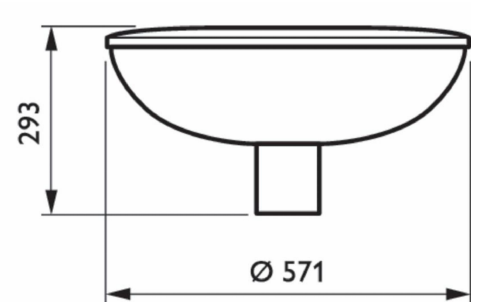
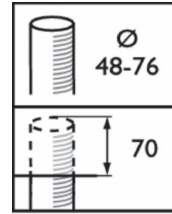

TOWNGUIDE PERF BOWL - LED module 4000 lm - 840 neutral white - Safety class II - Distribution symmetrical - Polycarbonate bowl/cover clear - Gray - Post-top for diameter 62 mm

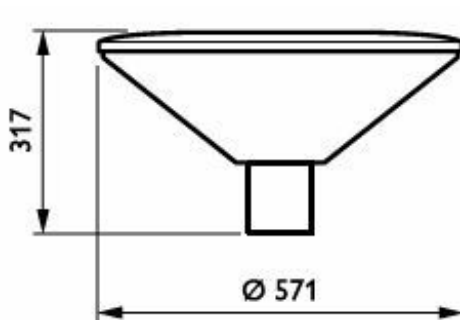
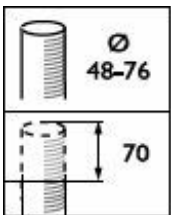

TOWNGUIDE PERF CLASSIC CONE - LED module 4000 lm - Distribution wide - Polycarbonate bowl/cover clear - LumiStep dimming 6 hours - Post-top for diameter 62 mm

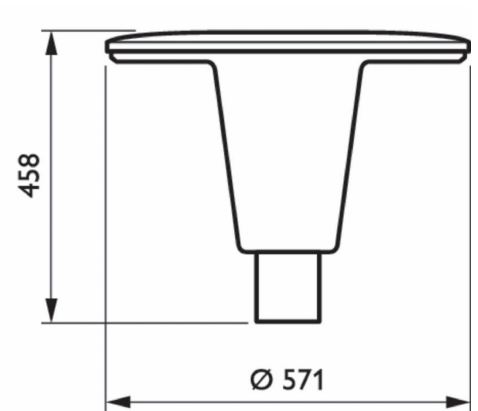
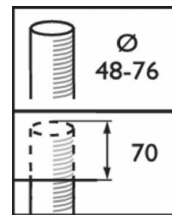

TOWNGUIDE PERF CLASSIC T - LED module 7000 lm - 740 neutral white - Safety class II - Distribution symmetrical - Polycarbonate bowl/cover clear - Black - Post-top for diameter 76 mm

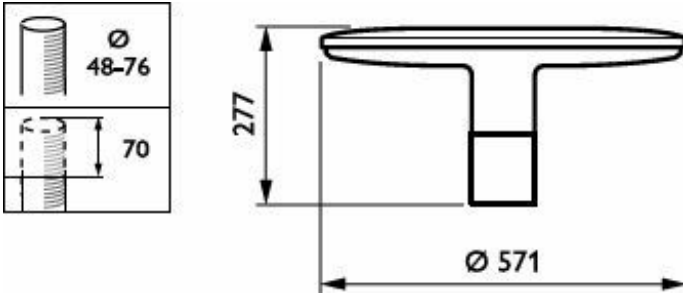

TOWNGUIDE PERFORMER Tzero - LED module 7000 lm

Product details



OPDP_BDP100i_0011-
Detail photo



OPDP_BDP100i_0001-
Detail photo



OPDP_BDP100i_0003-
Detail photo



OPDP_BDP100i_0007-
Detail photo



OPDP_BDP100i_0009-
Detail photo



TownGuide_Performer-
BDP100_105-DPP.TIF

General Information

Light source replaceable	Yes
Number of gear units	1 unit
Driver included	Yes
Service tag	Yes

Mechanical and Housing

Ingress protection code	IP66 [Dust penetration-protected, jet-proof]
Mech. impact protection code	IK10 [20 J vandal-resistant]
Standard tilt angle posttop	0°
Standard tilt angle side entry	-

Approval and Application

Glow-wire test	Temperature 650 °C, duration 5 s
Flammability mark	-
CE mark	Yes

Over Time Performance (IEC Compliant)

Driver failure rate at 5000 h	0.5 %
-------------------------------	-------

General Information

Order Code	Full Product Name	Lamp family code
910500991230	BDP101 LED40/830 II DM PCF SI 6 62P	LED40
910500991231	BDP101 LED40/740 II DM PCF SI 6 62P	LED40
910925866274	BDP101 LED40/830 II DW PCC GR 62P	LED40
910925866304	BDP101 LED40/740 II DS PCC GR MSP 62P	LED40
910500991147	BDP104 LED50/830 DW PCF SI CLO 62P	LED50
910925863302	BDP104 LED70/740 DRW PCC GR D9 62P	LED70
910925866625	BDP105 LED50/830 II DW PCC GR 62P	LED50
910925866627	BDP105 LED70/830 II DS PCC GR 62P	LED70
910500991138	BDP103 LED35/830 DW PCF SI CLO 62P	LED35
910500991142	BDP103 LED120/830 DW PCF SI CLO 62P	LED120
910925866471	BDP103 LED15/740 II DRW PCC GR 62P	LED15
910925866472	BDP103 LED15/740 II DRW PCC GR 76P	LED15
910925866473	BDP103 LED25/740 II DRW PCC GR 62P	LED25
910925866474	BDP103 LED25/740 II DRW PCC GR 76P	LED25
910925866624	BDP103 LED70/830 II DW PCC GR 62P	LED70
910925868807	BDP103 LED30/740 II DS PCC BK CLO 76P	LED30
910925868808	BDP103 LED50/740 II DS PCC BK CLO 76P	LED50
910925868809	BDP103 LED60/740 II DS PCC BK CLO 76P	LED60
910925868810	BDP103 LED70/740 II DS PCC BK CLO 76P	LED70
910500991010	BDP100 LED40/830 II DM PCC SI CLO-LS-6 6	LED40
910500991064	BDP100 LED60/740 II DS PCC SI LS-6 62P	LED60

Order Code	Full Product Name	Lamp family code
910500991112	BDP100 LED20/830 DW PCF SI CLO 62P	LED20
910500991015	BDP101 LED60/830 II DS PCF SI CLO-DDF2 6	LED60
910500991014	BDP101 LED60/830 II DM PCC SI CLO-DDF2 6	LED60
910500991021	BDP102 LED40/830 II DW PCC SI CLO-DDF1 6	LED40
910500991082	BDP102 LED60/740 II DW PCC SI LS-6 62P	LED60
910500991104	BDP102 LED60/830 II DS PCF SI LS-6 62P	LED60
910500991136	BDP103 LED20/830 DW PCF SI CLO 62P	LED20
910500991139	BDP103 LED50/830 DW PCF SI CLO 62P	LED50
910500991024	BDP104 LED30/740 II DM PCC SI CLO-LS-8 6	LED30
910500991009	BDP100 LED30/740 DN PCC SI CLO-LS-6 76P	LED30
910500991067	BDP100 LED60/740 II DS PCF SI LS-6 62P	LED60
910500991115	BDP100 LED50/830 DW PCF SI CLO 62P	LED50
910500991117	BDP100 LED100/830 DW PCF SI CLO 62P	LED100
910925452181	BDP100 LED40/740 DS PCC GR DDF27 62P	LED40
910925863295	BDP100 LED70/740 DS PCC GR D9 62P	LED70
910925866272	BDP100 LED40/830 II DW PCC GR 62P	LED40
910925866276	BDP100 LED40/740 II DW PCC GR 62P	LED40
910925866277	BDP100 LED50/740 II DW PCC GR 62P	LED50
910925866278	BDP100 LED70/740 II DW PCC GR 62P	LED70
910925866281	BDP100 LED70/740 II DW PCF GR 62P	LED70
910925866282	BDP100 LED30/740 II DS PCC GR 62P	LED30
910925866288	BDP100 LED50/830 II DW PCC GR 62P	LED50
910925866289	BDP100 LED70/830 II DW PCC GR 62P	LED70
910925866294	BDP100 LED50/830 II DS PCC GR 62P	LED50
910925866297	BDP100 LED70/830 II DS PCF GR 62P	LED70
910925866302	BDP100 LED40/740 II DS PCC GR 62P	LED40
910925868060	BDP100 LED50/730 II DS PCC GR 62P	LED50
910925868063	BDP100 LED50/730 II DW PCC GR 62P	LED50
910925868067	BDP100 LED70/730 II DW PCC GR 62P	LED70
910925868095	BDP100 LED40/830 DS PCC ALU 76P	LED40
910500991023	BDP102 LED50/830 II DS PCF SI CLO-DDF1 6	LED50
910500991088	BDP102 LED60/740 II DS PCC SI LS-6 62P	LED60
910500991091	BDP102 LED60/740 II DS PCF SI LS-6 62P	LED60
910500991092	BDP102 LED40/830 II DW PCC SI LS-6 62P	LED40
910500991098	BDP102 LED40/830 II DS PCC SI LS-6 62P	LED40
910500991101	BDP102 LED60/830 II DS PCC SI LS-6 62P	LED60
910500991128	BDP102 LED20/830 DW PCF SI CLO 62P	LED20
910500991129	BDP102 LED30/830 DW PCF SI CLO 62P	LED30
910500991130	BDP102 LED35/830 DW PCF SI CLO 62P	LED35
910500991131	BDP102 LED50/830 DW PCF SI CLO 62P	LED50

Order Code	Full Product Name	Lamp family code
910500991132	BDP102 LED70/830 DW PCF SI CLO 62P	LED70
910500991211	BDP102 LED50/830 DM PCC GR MSP 62P	LED50
910500991222	BDP102 LED35/830 II DW PCF SI LS-8 62P	LED35
910500991224	BDP102 LED60/830 II DW PCF SI LS-8 62P	LED60
910500991232	BDP102 LED40/830 II DM PCF SI 6 62P	LED40
910500991233	BDP102 LED40/740 II DM PCF SI 6 62P	LED40
910925863297	BDP102 LED70/740 DRW PCC GR D9 62P	LED70

Light Technical

Order Code	Full Product Name	Upward light output ratio	Luminous Flux	Correlated Color Temperature (Nom)	Color rendering index (CRI)	Number of light sources	Light source color	Luminaire light beam spread	Optic type outdoor
910500991230	BDP101 LED40/830 II DM PCF SI 6 62P	15	2,320 lm	3000 K	80	4	830 warm white	53° x 71°	Distribution medium
910500991231	BDP101 LED40/740 II DM PCF SI 6 62P	15	2,320 lm	4000 K	70	4	740 neutral white	53° x 71°	Distribution medium
910925866274	BDP101 LED40/830 II DW PCC GR 62P	3	3,200 lm	3000 K	80	-	830 warm white	50° x 70°	Distribution wide
910925866304	BDP101 LED40/740 II DS PCC GR MSP 62P	3	3,320 lm	4000 K	70	-	740 neutral white	75°	Distribution symmetrical
910500991147	BDP104 LED50/830 DW PCF SI CLO 62P	3	2,208 lm	3000 K	80	6	830 warm white	50° x 70°	Distribution wide
910925863302	BDP104 LED70/740 DRW PCC GR D9 62P	3	4,620 lm	4000 K	70	8	740 neutral white	39° x 96°	Distribution residential wide
910925866625	BDP105 LED50/830 II DW PCC GR 62P	0	3,400 lm	3000 K	80	-	830 warm white	50° x 70°	Distribution wide
910925866627	BDP105 LED70/830 II DS PCC GR 62P	0	4,830 lm	3000 K	80	-	830 warm white	75°	Distribution wide
910500991138	BDP103 LED35/830 DW PCF SI CLO 62P	4	1,716 lm	3000 K	80	4	830 warm white	50° x 70°	Distribution wide
910500991142	BDP103 LED120/830 DW PCF SI CLO 62P	4	4,800 lm	3000 K	80	8	830 warm white	50° x 70°	Distribution wide
910925866471	BDP103 LED15/740 II DRW PCC GR 62P	3	1,110 lm	4000 K	70	-	740 neutral white	39° x 96°	Distribution residential wide
910925866472	BDP103 LED15/740 II DRW PCC GR 76P	3	1,110 lm	4000 K	70	-	740 neutral white	39° x 96°	Distribution residential wide
910925866473	BDP103 LED25/740 II DRW PCC GR 62P	3	1,625 lm	4000 K	70	-	740 neutral white	39° x 96°	Distribution residential wide

Order Code	Full Product Name	Upward light output ratio	Luminous Flux	Correlated Color Temperature (Nom)	Color rendering index (CRI)	Number of light sources	Light source color	Luminaire light beam spread	Optic type outdoor
910925866474	BDP103 LED25/740 II DRW PCC GR 76P	3	1,625 lm	4000 K	70	-	740 neutral white	39° x 96°	Distribution residential wide
910925866624	BDP103 LED70/830 II DW PCC GR 62P	4	5,180 lm	3000 K	80	-	830 warm white	50° x 70°	Distribution symmetrical
910925868807	BDP103 LED30/740 II DS PCC BK CLO 76P	3	2,204 lm	4000 K	70	-	740 neutral white	75°	Distribution symmetrical
910925868808	BDP103 LED50/740 II DS PCC BK CLO 76P	3	3,800 lm	4000 K	70	-	740 neutral white	75°	Distribution symmetrical
910925868809	BDP103 LED60/740 II DS PCC BK CLO 76P	3	4,500 lm	4000 K	70	-	740 neutral white	75°	Distribution symmetrical
910925868810	BDP103 LED70/740 II DS PCC BK CLO 76P	3	5,250 lm	4000 K	70	-	740 neutral white	75°	Distribution symmetrical
910500991010	BDP100 LED40/830 II DM PCC SI CLO-LS-6 6	3	2,888 lm	3000 K	80	4	830 warm white	53° x 71°	Distribution medium
910500991064	BDP100 LED60/740 II DS PCC SI LS-6 62P	3	4,500 lm	4000 K	70	4	740 neutral white	75°	Distribution symmetrical
910500991112	BDP100 LED20/830 DW PCF SI CLO 62P	3	1,160 lm	3000 K	80	4	830 warm white	50° x 70°	Distribution wide
910500991015	BDP101 LED60/830 II DS PCF SI CLO-DDF2 6	15	2,300 lm	3000 K	80	8	830 warm white	75°	Distribution symmetrical
910500991014	BDP101 LED60/830 II DM PCC SI CLO-DDF2 6	3	4,424 lm	3000 K	80	8	830 warm white	53° x 71°	Distribution medium
910500991021	BDP102 LED40/830 II DW PCC SI CLO-DDF1 6	3	3,116 lm	3000 K	80	4	830 warm white	50° x 70°	Distribution wide
910500991082	BDP102 LED60/740 II DW PCC SI LS-6 62P	3	4,680 lm	4000 K	70	4	740 neutral white	50° x 70°	Distribution wide
910500991104	BDP102 LED60/830 II DS PCF SI LS-6 62P	10	3,360 lm	3000 K	80	4	830 warm white	75°	Distribution symmetrical
910500991136	BDP103 LED20/830 DW PCF SI CLO 62P	4	1,060 lm	3000 K	80	4	830 warm white	50° x 70°	Distribution wide
910500991139	BDP103 LED50/830 DW PCF SI CLO 62P	4	2,346 lm	3000 K	80	6	830 warm white	50° x 70°	Distribution wide

Order Code	Full Product Name	Upward light output ratio	Luminous Flux	Correlated Color Temperature (Nom)	Color rendering index (CRI)	Number of light sources	Light source color	Luminaire light beam spread	Optic type outdoor
910500991024	BDP104 LED30/740 II DM PCC SI CLO-LS-86	3	2,204 lm	4000 K	70	4	740 neutral white	53° x 71°	Distribution medium
910500991009	BDP100 LED30/740 DN PCC SI CLO-LS-676P	3	2,291 lm	4000 K	70	4	740 neutral white	32° x 29°	Distribution narrow
910500991067	BDP100 LED60/740 II DS PCF SI LS-6 62P	3	3,240 lm	4000 K	70	4	840 neutral white	75°	Distribution symmetrical
910500991115	BDP100 LED50/830 DW PCF SI CLO 62P	3	2,576 lm	3000 K	80	6	830 warm white	50° x 70°	Distribution wide
910500991117	BDP100 LED100/830 DW PCF SI CLO 62P	3	4,240 lm	3000 K	80	6	830 warm white	50° x 70°	Distribution wide
910925452181	BDP100 LED40/740 DS PCC GR DDF27 62P	3	3,080 lm	4000 K	70	-	740 neutral white	75°	Distribution symmetrical
910925863295	BDP100 LED70/740 DS PCC GR D9 62P	3	5,250 lm	4000 K	70	8	740 neutral white	75°	Distribution symmetrical
910925866272	BDP100 LED40/830 II DW PCC GR 62P	3	3,040 lm	3000 K	80	-	830 warm white	50° x 70°	Distribution wide
910925866276	BDP100 LED40/740 II DW PCC GR 62P	3	3,040 lm	4000 K	70	-	740 neutral white	50° x 70°	Distribution wide
910925866277	BDP100 LED50/740 II DW PCC GR 62P	3	3,750 lm	4000 K	70	-	740 neutral white	50° x 70°	Distribution wide
910925866278	BDP100 LED70/740 II DW PCC GR 62P	3	5,250 lm	4000 K	70	-	740 neutral white	50° x 70°	Distribution wide
910925866281	BDP100 LED70/740 II DW PCF GR 62P	3	3,780 lm	4000 K	70	-	740 neutral white	50° x 70°	Distribution wide
910925866282	BDP100 LED30/740 II DS PCC GR 62P	3	2,340 lm	4000 K	70	-	740 neutral white	75°	Distribution symmetrical
910925866288	BDP100 LED50/830 II DW PCC GR 62P	3	3,700 lm	3000 K	80	-	830 warm white	50° x 70°	Distribution wide
910925866289	BDP100 LED70/830 II DW PCC GR 62P	3	5,250 lm	3000 K	80	-	830 warm white	50° x 70°	Distribution wide
910925866294	BDP100 LED50/830 II DS PCC GR 62P	3	3,800 lm	3000 K	80	-	830 warm white	75°	Distribution symmetrical
910925866297	BDP100 LED70/830 II DS PCF GR 62P	3	3,780 lm	3000 K	80	-	830 warm white	75°	Distribution symmetrical
910925866302	BDP100 LED40/740 II DS PCC GR 62P	3	3,080 lm	4000 K	70	-	740 neutral white	75°	Distribution symmetrical

Order Code	Full Product Name	Upward light output ratio	Luminous Flux	Correlated Color Temperature (Nom)	Color rendering index (CRI)	Number of light sources	Light source color	Luminaire light beam spread	Optic type outdoor
910925868060	BDP100 LED50/730 II DS PCC GR 62P	3	3,700 lm	3000 K	70	-	730 warm white	50° x 70°	Distribution symmetrical
910925868063	BDP100 LED50/730 II DW PCC GR 62P	3	3,700 lm	3000 K	70	-	730 warm white	50° x 70°	Distribution wide
910925868067	BDP100 LED70/730 II DW PCC GR 62P	3	5,250 lm	3000 K	70	-	730 warm white	50° x 70°	Distribution wide
910925868095	BDP100 LED40/830 DS PCC ALU 76P	3	3,080 lm	3000 K	80	-	830 warm white	75°	Distribution symmetrical
910500991023	BDP102 LED50/830 II DS PCF SI CLO-DDF1 6	10	1,900 lm	3000 K	80	4	830 warm white	75°	Distribution symmetrical
910500991088	BDP102 LED60/740 II DS PCC SI LS-6 62P	3	4,740 lm	4000 K	70	4	740 neutral white	75°	Distribution symmetrical
910500991091	BDP102 LED60/740 II DS PCF SI LS-6 62P	10	3,360 lm	4000 K	70	4	740 neutral white	75°	Distribution symmetrical
910500991092	BDP102 LED40/830 II DW PCC SI LS-6 62P	3	3,160 lm	3000 K	80	3	830 warm white	50° x 70°	Distribution wide
910500991098	BDP102 LED40/830 II DS PCC SI LS-6 62P	3	3,280 lm	3000 K	80	3	830 warm white	75°	Distribution symmetrical
910500991101	BDP102 LED60/830 II DS PCC SI LS-6 62P	3	4,740 lm	3000 K	80	4	830 warm white	75°	Distribution symmetrical
910500991128	BDP102 LED20/830 DW PCF SI CLO 62P	10	1,200 lm	3000 K	80	4	830 warm white	50° x 70°	Distribution wide
910500991129	BDP102 LED30/830 DW PCF SI CLO 62P	10	1,740 lm	3000 K	80	4	830 warm white	50° x 70°	Distribution wide
910500991130	BDP102 LED35/830 DW PCF SI CLO 62P	10	1,947 lm	3000 K	80	4	830 warm white	50° x 70°	Distribution wide
910500991131	BDP102 LED50/830 DW PCF SI CLO 62P	10	2,714 lm	3000 K	80	6	830 warm white	50° x 70°	Distribution wide
910500991132	BDP102 LED70/830 DW PCF SI CLO 62P	10	3,584 lm	3000 K	80	8	830 warm white	50° x 70°	Distribution wide
910500991211	BDP102 LED50/830 DM PCC GR MSP 62P	3	3,900 lm	3000 K	80	6	830 warm white	53° x 71°	Distribution medium
910500991222	BDP102 LED35/830 II DW PCF SI LS-8 62P	10	1,995 lm	3000 K	80	4	830 warm white	50° x 70°	Distribution wide
910500991224	BDP102 LED60/830 II DW PCF SI LS-8 62P	10	3,300 lm	3000 K	80	8	830 warm white	50° x 70°	Distribution wide
910500991232	BDP102 LED40/830 II DM PCF SI 6 62P	10	2,240 lm	3000 K	80	4	830 warm white	53° x 71°	Distribution medium
910500991233	BDP102 LED40/740 II DM PCF SI 6 62P	10	2,240 lm	4000 K	70	4	740 neutral white	53° x 71°	Distribution medium
910925863297	BDP102 LED70/740 DRW PCC GR D9 62P	3	4,900 lm	4000 K	70	8	740 neutral white	39° x 96°	Distribution residential wide

Operating and Electrical

Order Code	Full Product Name	Power Consumption	Surge Protection (Common/Differential)
910500991230	BDP101 LED40/830 II DM PCF SI 6 62P	32.5 W	Surge protection level until 6 kV differential mode and 6 kV common mode
910500991231	BDP101 LED40/740 II DM PCF SI 6 62P	27.5 W	Surge protection level until 6 kV differential mode and 6 kV common mode
910925866274	BDP101 LED40/830 II DW PCC GR 62P	32.5 W	Surge protection level until 6 kV differential mode and 6 kV common mode
910925866304	BDP101 LED40/740 II DS PCC GR MSP 62P	27.5 W	Surge protection level until 6 kV differential mode and 6 kV common mode
910500991147	BDP104 LED50/830 DW PCF SI CLO 62P	40 W	Surge protection level until 6 kV differential mode and 6 kV common mode
910925863302	BDP104 LED70/740 DRW PCC GR D9 62P	45.5 W	Surge protection level until 6 kV differential mode and 6 kV common mode
910925866625	BDP105 LED50/830 II DW PCC GR 62P	41 W	Surge protection level until 6 kV differential mode and 6 kV common mode
910925866627	BDP105 LED70/830 II DS PCC GR 62P	56 W	Surge protection level until 6 kV differential mode and 6 kV common mode
910500991138	BDP103 LED35/830 DW PCF SI CLO 62P	27 W	Surge protection level until 6 kV differential mode and 6 kV common mode
910500991142	BDP103 LED120/830 DW PCF SI CLO 62P	92 W	Surge protection level until 6 kV differential mode and 6 kV common mode
910925866471	BDP103 LED15/740 II DRW PCC GR 62P	11 W	Surge protection level until 6 kV differential mode and 6 kV common mode
910925866472	BDP103 LED15/740 II DRW PCC GR 76P	11 W	Surge protection level until 6 kV differential mode and 6 kV common mode
910925866473	BDP103 LED25/740 II DRW PCC GR 62P	16.6 W	Surge protection level until 6 kV differential mode and 6 kV common mode
910925866474	BDP103 LED25/740 II DRW PCC GR 76P	16.6 W	Surge protection level until 6 kV differential mode and 6 kV common mode
910925866624	BDP103 LED70/830 II DW PCC GR 62P	56 W	Surge protection level until 6 kV differential mode and 6 kV common mode
910925868807	BDP103 LED30/740 II DS PCC BK CLO 76P	19.6 W	Surge protection level until 6 kV differential mode and 6 kV common mode
910925868808	BDP103 LED50/740 II DS PCC BK CLO 76P	35 W	Surge protection level until 6 kV differential mode and 6 kV common mode
910925868809	BDP103 LED60/740 II DS PCC BK CLO 76P	39 W	Surge protection level until 6 kV differential mode and 6 kV common mode
910925868810	BDP103 LED70/740 II DS PCC BK CLO 76P	49.5 W	Surge protection level until 6 kV differential mode and 6 kV common mode
910500991010	BDP100 LED40/830 II DM PCC SI CLO-LS-6 6	32.5 W	Surge protection level until 6 kV differential mode and 6 kV common mode
910500991064	BDP100 LED60/740 II DS PCC SI LS-6 62P	39 W	Surge protection level until 6 kV differential mode and 6 kV common mode
910500991112	BDP100 LED20/830 DW PCF SI CLO 62P	15.8 W	Surge protection level until 4 kV differential mode and 4 kV common mode
910500991015	BDP101 LED60/830 II DS PCF SI CLO-DDF2 6	40 W	Surge protection level until 6 kV differential mode and 6 kV common mode

Order Code	Full Product Name	Power Consumption	Surge Protection (Common/Differential)
910500991014	BDP101 LED60/830 II DM PCC SI CLO-DDF2 6	46.5 W	Surge protection level until 6 kV differential mode and 6 kV common mode
910500991021	BDP102 LED40/830 II DW PCC SI CLO-DDF1 6	32.5 W	Surge protection level until 6 kV differential mode and 6 kV common mode
910500991082	BDP102 LED60/740 II DW PCC SI LS-6 62P	39 W	Surge protection level until 6 kV differential mode and 6 kV common mode
910500991104	BDP102 LED60/830 II DS PCF SI LS-6 62P	47 W	Surge protection level until 6 kV differential mode and 6 kV common mode
910500991136	BDP103 LED20/830 DW PCF SI CLO 62P	15.8 W	Surge protection level until 6 kV differential mode and 6 kV common mode
910500991139	BDP103 LED50/830 DW PCF SI CLO 62P	40 W	Surge protection level until 6 kV differential mode and 6 kV common mode
910500991024	BDP104 LED30/740 II DM PCC SI CLO-LS-8 6	19.6 W	Surge protection level until 6 kV differential mode and 6 kV common mode
910500991009	BDP100 LED30/740 DN PCC SI CLO-LS-6 76P	19.6 W	Surge protection level until 6 kV differential mode and 6 kV common mode
910500991067	BDP100 LED60/740 II DS PCF SI LS-6 62P	39 W	Surge protection level until 6 kV differential mode and 6 kV common mode
910500991115	BDP100 LED50/830 DW PCF SI CLO 62P	40 W	Surge protection level until 6 kV differential mode and 6 kV common mode
910500991117	BDP100 LED100/830 DW PCF SI CLO 62P	74 W	Surge protection level until 6 kV differential mode and 6 kV common mode
910925452181	BDP100 LED40/740 DS PCC GR DDF27 62P	27.5 W	Surge protection level until 6 kV differential mode and 6 kV common mode
910925863295	BDP100 LED70/740 DS PCC GR D9 62P	45.5 W	Surge protection level until 6 kV differential mode and 6 kV common mode
910925866272	BDP100 LED40/830 II DW PCC GR 62P	32.5 W	Surge protection level until 6 kV differential mode and 6 kV common mode
910925866276	BDP100 LED40/740 II DW PCC GR 62P	27.5 W	Surge protection level until 6 kV differential mode and 6 kV common mode
910925866277	BDP100 LED50/740 II DW PCC GR 62P	34 W	Surge protection level until 6 kV differential mode and 6 kV common mode
910925866278	BDP100 LED70/740 II DW PCC GR 62P	45.5 W	Surge protection level until 6 kV differential mode and 6 kV common mode
910925866281	BDP100 LED70/740 II DW PCF GR 62P	45.5 W	Surge protection level until 6 kV differential mode and 6 kV common mode
910925866282	BDP100 LED30/740 II DS PCC GR 62P	19.6 W	Surge protection level until 6 kV differential mode and 6 kV common mode
910925866288	BDP100 LED50/830 II DW PCC GR 62P	41 W	Surge protection level until 6 kV differential mode and 6 kV common mode
910925866289	BDP100 LED70/830 II DW PCC GR 62P	56 W	Surge protection level until 6 kV differential mode and 6 kV common mode
910925866294	BDP100 LED50/830 II DS PCC GR 62P	41 W	Surge protection level until 6 kV differential mode and 6 kV common mode
910925866297	BDP100 LED70/830 II DS PCF GR 62P	56 W	Surge protection level until 6 kV differential mode and 6 kV common mode
910925866302	BDP100 LED40/740 II DS PCC GR 62P	27.5 W	Surge protection level until 6 kV differential mode and 6 kV common mode

Order Code	Full Product Name	Power Consumption	Surge Protection (Common/Differential)
910925868060	BDP100 LED50/730 II DS PCC GR 62P	36.5 W	Surge protection level until 6 kV differential mode and 6 kV common mode
910925868063	BDP100 LED50/730 II DW PCC GR 62P	36.5 W	Surge protection level until 6 kV differential mode and 6 kV common mode
910925868067	BDP100 LED70/730 II DW PCC GR 62P	49.5 W	Surge protection level until 6 kV differential mode and 6 kV common mode
910925868095	BDP100 LED40/830 DS PCC ALU 76P	32.5 W	Surge protection level until 6 kV differential mode and 6 kV common mode
910500991023	BDP102 LED50/830 II DS PCF SI CLO- DDF1 6	32.5 W	Surge protection level until 6 kV differential mode and 6 kV common mode
910500991088	BDP102 LED60/740 II DS PCC SI LS-6 62P	39 W	Surge protection level until 6 kV differential mode and 6 kV common mode
910500991091	BDP102 LED60/740 II DS PCF SI LS-6 62P	39 W	Surge protection level until 6 kV differential mode and 6 kV common mode
910500991092	BDP102 LED40/830 II DW PCC SI LS-6 62P	32.5 W	Surge protection level until 6 kV differential mode and 6 kV common mode
910500991098	BDP102 LED40/830 II DS PCC SI LS-6 62P	32.5 W	Surge protection level until 6 kV differential mode and 6 kV common mode
910500991101	BDP102 LED60/830 II DS PCC SI LS-6 62P	47 W	Surge protection level until 6 kV differential mode and 6 kV common mode
910500991128	BDP102 LED20/830 DW PCF SI CLO 62P	15.8 W	Surge protection level until 6 kV differential mode and 6 kV common mode
910500991129	BDP102 LED30/830 DW PCF SI CLO 62P	23.5 W	Surge protection level until 6 kV differential mode and 6 kV common mode
910500991130	BDP102 LED35/830 DW PCF SI CLO 62P	27 W	Surge protection level until 6 kV differential mode and 6 kV common mode
910500991131	BDP102 LED50/830 DW PCF SI CLO 62P	40 W	Surge protection level until 6 kV differential mode and 6 kV common mode
910500991132	BDP102 LED70/830 DW PCF SI CLO 62P	54 W	Surge protection level until 6 kV differential mode and 6 kV common mode
910500991211	BDP102 LED50/830 DM PCC GR MSP 62P	41 W	Surge protection level until 6 kV differential mode and 6 kV common mode
910500991222	BDP102 LED35/830 II DW PCF SI LS-8 62P	27.5 W	Surge protection level until 6 kV differential mode and 6 kV common mode
910500991224	BDP102 LED60/830 II DW PCF SI LS-8 62P	47 W	Surge protection level until 6 kV differential mode and 6 kV common mode
910500991232	BDP102 LED40/830 II DM PCF SI 6 62P	32.5 W	Surge protection level until 6 kV differential mode and 6 kV common mode
910500991233	BDP102 LED40/740 II DM PCF SI 6 62P	27.5 W	Surge protection level until 6 kV differential mode and 6 kV common mode
910925863297	BDP102 LED70/740 DRW PCC GR D9 62P	45.5 W	Surge protection level until 6 kV differential mode and 6 kV common mode

Controls and Dimming

Order Code	Full Product Name	Dimmable	Maximum dim level
910500991230	BDP101 LED40/830 II DM PCF SI 6 62P	No	Not applicable

Order Code	Full Product Name	Dimmable	Maximum dim level
910500991231	BDP101 LED40/740 II DM PCF SI 6 62P	No	Not applicable
910925866274	BDP101 LED40/830 II DW PCC GR 62P	No	Not applicable
910925866304	BDP101 LED40/740 II DS PCC GR MSP 62P	No	Not applicable
910500991147	BDP104 LED50/830 DW PCF SI CLO 62P	No	Not applicable
910925863302	BDP104 LED70/740 DRW PCC GR D9 62P	Yes	0% (digital)
910925866625	BDP105 LED50/830 II DW PCC GR 62P	No	Not applicable
910925866627	BDP105 LED70/830 II DS PCC GR 62P	No	Not applicable
910500991138	BDP103 LED35/830 DW PCF SI CLO 62P	No	Not applicable
910500991142	BDP103 LED120/830 DW PCF SI CLO 62P	No	Not applicable
910925866471	BDP103 LED15/740 II DRW PCC GR 62P	No	Not applicable
910925866472	BDP103 LED15/740 II DRW PCC GR 76P	No	Not applicable
910925866473	BDP103 LED25/740 II DRW PCC GR 62P	No	Not applicable
910925866474	BDP103 LED25/740 II DRW PCC GR 76P	No	Not applicable
910925866624	BDP103 LED70/830 II DW PCC GR 62P	No	Not applicable
910925868807	BDP103 LED30/740 II DS PCC BK CLO 76P	No	Not applicable
910925868808	BDP103 LED50/740 II DS PCC BK CLO 76P	No	Not applicable
910925868809	BDP103 LED60/740 II DS PCC BK CLO 76P	No	Not applicable
910925868810	BDP103 LED70/740 II DS PCC BK CLO 76P	No	Not applicable
910500991010	BDP100 LED40/830 II DM PCC SI CLO-LS-6 6	Yes	50%
910500991064	BDP100 LED60/740 II DS PCC SI LS-6 62P	Yes	50%
910500991112	BDP100 LED20/830 DW PCF SI CLO 62P	No	Not applicable
910500991015	BDP101 LED60/830 II DS PCF SI CLO-DDF2 6	Yes	50%
910500991014	BDP101 LED60/830 II DM PCC SI CLO-DDF2 6	Yes	50%
910500991021	BDP102 LED40/830 II DW PCC SI CLO-DDF1 6	Yes	50%
910500991082	BDP102 LED60/740 II DW PCC SI LS-6 62P	Yes	50%
910500991104	BDP102 LED60/830 II DS PCF SI LS-6 62P	Yes	50%
910500991136	BDP103 LED20/830 DW PCF SI CLO 62P	No	Not applicable
910500991139	BDP103 LED50/830 DW PCF SI CLO 62P	No	Not applicable
910500991024	BDP104 LED30/740 II DM PCC SI CLO-LS-8 6	Yes	50%
910500991009	BDP100 LED30/740 DN PCC SI CLO-LS-6 76P	Yes	50%
910500991067	BDP100 LED60/740 II DS PCF SI LS-6 62P	Yes	50%
910500991115	BDP100 LED50/830 DW PCF SI CLO 62P	No	Not applicable
910500991117	BDP100 LED100/830 DW PCF SI CLO 62P	No	Not applicable
910925452181	BDP100 LED40/740 DS PCC GR DDF27 62P	Yes	50%
910925863295	BDP100 LED70/740 DS PCC GR D9 62P	Yes	0% (digital)
910925866272	BDP100 LED40/830 II DW PCC GR 62P	No	Not applicable
910925866276	BDP100 LED40/740 II DW PCC GR 62P	No	Not applicable
910925866277	BDP100 LED50/740 II DW PCC GR 62P	No	Not applicable
910925866278	BDP100 LED70/740 II DW PCC GR 62P	No	Not applicable
910925866281	BDP100 LED70/740 II DW PCF GR 62P	No	Not applicable

Order Code	Full Product Name	Dimmable	Maximum dim level
910925866282	BDP100 LED30/740 II DS PCC GR 62P	No	Not applicable
910925866288	BDP100 LED50/830 II DW PCC GR 62P	No	Not applicable
910925866289	BDP100 LED70/830 II DW PCC GR 62P	No	Not applicable
910925866294	BDP100 LED50/830 II DS PCC GR 62P	No	Not applicable
910925866297	BDP100 LED70/830 II DS PCF GR 62P	No	Not applicable
910925866302	BDP100 LED40/740 II DS PCC GR 62P	No	Not applicable
910925868060	BDP100 LED50/730 II DS PCC GR 62P	No	Not applicable
910925868063	BDP100 LED50/730 II DW PCC GR 62P	No	Not applicable
910925868067	BDP100 LED70/730 II DW PCC GR 62P	No	Not applicable
910925868095	BDP100 LED40/830 DS PCC ALU 76P	No	Not applicable
910500991023	BDP102 LED50/830 II DS PCF SI CLO-DDF1 6	Yes	50%
910500991088	BDP102 LED60/740 II DS PCC SI LS-6 62P	Yes	50%
910500991091	BDP102 LED60/740 II DS PCF SI LS-6 62P	Yes	50%
910500991092	BDP102 LED40/830 II DW PCC SI LS-6 62P	Yes	50%
910500991098	BDP102 LED40/830 II DS PCC SI LS-6 62P	Yes	50%
910500991101	BDP102 LED60/830 II DS PCC SI LS-6 62P	Yes	50%
910500991128	BDP102 LED20/830 DW PCF SI CLO 62P	No	Not applicable
910500991129	BDP102 LED30/830 DW PCF SI CLO 62P	No	Not applicable
910500991130	BDP102 LED35/830 DW PCF SI CLO 62P	No	Not applicable
910500991131	BDP102 LED50/830 DW PCF SI CLO 62P	No	Not applicable
910500991132	BDP102 LED70/830 DW PCF SI CLO 62P	No	Not applicable
910500991211	BDP102 LED50/830 DM PCC GR MSP 62P	No	Not applicable
910500991222	BDP102 LED35/830 II DW PCF SI LS-8 62P	Yes	50%
910500991224	BDP102 LED60/830 II DW PCF SI LS-8 62P	Yes	50%
910500991232	BDP102 LED40/830 II DM PCF SI 6 62P	No	Not applicable
910500991233	BDP102 LED40/740 II DM PCF SI 6 62P	No	Not applicable
910925863297	BDP102 LED70/740 DRW PCC GR D9 62P	Yes	0% (digital)

Mechanical and Housing

Order Code	Full Product Name	Housing Color	Optical cover type
910500991230	BDP101 LED40/830 II DM PCF SI 6 62P	Silver	Polycarbonate bowl/cover frosted
910500991231	BDP101 LED40/740 II DM PCF SI 6 62P	Silver	Polycarbonate bowl/cover frosted
910925866274	BDP101 LED40/830 II DW PCC GR 62P	Gray	Polycarbonate bowl/cover clear
910925866304	BDP101 LED40/740 II DS PCC GR MSP 62P	Gray	Polycarbonate bowl/cover clear
910500991147	BDP104 LED50/830 DW PCF SI CLO 62P	Silver	Polycarbonate bowl/cover frosted
910925863302	BDP104 LED70/740 DRW PCC GR D9 62P	Gray	Polycarbonate bowl/cover clear
910925866625	BDP105 LED50/830 II DW PCC GR 62P	Gray	Polycarbonate bowl/cover clear
910925866627	BDP105 LED70/830 II DS PCC GR 62P	Gray	Polycarbonate bowl/cover clear
910500991138	BDP103 LED35/830 DW PCF SI CLO 62P	Silver	Polycarbonate bowl/cover frosted

Order Code	Full Product Name	Housing Color	Optical cover type
910500991142	BDP103 LED120/830 DW PCF SI CLO 62P	Silver	Polycarbonate bowl/cover frosted
910925866471	BDP103 LED15/740 II DRW PCC GR 62P	Gray	Polycarbonate bowl/cover frosted
910925866472	BDP103 LED15/740 II DRW PCC GR 76P	Gray	Polycarbonate bowl/cover frosted
910925866473	BDP103 LED25/740 II DRW PCC GR 62P	Gray	Polycarbonate bowl/cover frosted
910925866474	BDP103 LED25/740 II DRW PCC GR 76P	Gray	Polycarbonate bowl/cover frosted
910925866624	BDP103 LED70/830 II DW PCC GR 62P	Gray	Polycarbonate bowl/cover clear
910925868807	BDP103 LED30/740 II DS PCC BK CLO 76P	Black	Polycarbonate bowl/cover clear
910925868808	BDP103 LED50/740 II DS PCC BK CLO 76P	Black	Polycarbonate bowl/cover clear
910925868809	BDP103 LED60/740 II DS PCC BK CLO 76P	Black	Polycarbonate bowl/cover clear
910925868810	BDP103 LED70/740 II DS PCC BK CLO 76P	Black	Polycarbonate bowl/cover clear
910500991010	BDP100 LED40/830 II DM PCC SI CLO-LS-6 6	Silver	Polycarbonate bowl/cover clear
910500991064	BDP100 LED60/740 II DS PCC SI LS-6 62P	Silver	Polycarbonate bowl/cover clear
910500991112	BDP100 LED20/830 DW PCF SI CLO 62P	Silver	Polycarbonate bowl/cover frosted
910500991015	BDP101 LED60/830 II DS PCF SI CLO-DDF2 6	Silver	Polycarbonate bowl/cover frosted
910500991014	BDP101 LED60/830 II DM PCC SI CLO-DDF2 6	Silver	Polycarbonate bowl/cover clear
910500991021	BDP102 LED40/830 II DW PCC SI CLO-DDF1 6	Silver	Polycarbonate bowl/cover clear
910500991082	BDP102 LED60/740 II DW PCC SI LS-6 62P	Silver	Polycarbonate bowl/cover clear
910500991104	BDP102 LED60/830 II DS PCF SI LS-6 62P	Silver	Polycarbonate bowl/cover frosted
910500991136	BDP103 LED20/830 DW PCF SI CLO 62P	Silver	Polycarbonate bowl/cover frosted
910500991139	BDP103 LED50/830 DW PCF SI CLO 62P	Silver	Polycarbonate bowl/cover frosted
910500991024	BDP104 LED30/740 II DM PCC SI CLO-LS-8 6	Silver	Polycarbonate bowl/cover clear
910500991009	BDP100 LED30/740 DN PCC SI CLO-LS-6 76P	Silver	Polycarbonate bowl/cover clear
910500991067	BDP100 LED60/740 II DS PCF SI LS-6 62P	Silver	Polycarbonate bowl/cover frosted
910500991115	BDP100 LED50/830 DW PCF SI CLO 62P	Silver	Polycarbonate bowl/cover frosted
910500991117	BDP100 LED100/830 DW PCF SI CLO 62P	Silver	Polycarbonate bowl/cover frosted
910925452181	BDP100 LED40/740 DS PCC GR DDF27 62P	Gray	Polycarbonate bowl/cover clear
910925863295	BDP100 LED70/740 DS PCC GR D9 62P	Gray	Polycarbonate bowl/cover clear
910925866272	BDP100 LED40/830 II DW PCC GR 62P	Gray	Polycarbonate bowl/cover clear
910925866276	BDP100 LED40/740 II DW PCC GR 62P	Gray	Polycarbonate bowl/cover clear
910925866277	BDP100 LED50/740 II DW PCC GR 62P	Gray	Polycarbonate bowl/cover clear
910925866278	BDP100 LED70/740 II DW PCC GR 62P	Gray	Polycarbonate bowl/cover clear
910925866281	BDP100 LED70/740 II DW PCF GR 62P	Gray	Polycarbonate bowl/cover frosted
910925866282	BDP100 LED30/740 II DS PCC GR 62P	Gray	Polycarbonate bowl/cover clear
910925866288	BDP100 LED50/830 II DW PCC GR 62P	Gray	Polycarbonate bowl/cover clear
910925866289	BDP100 LED70/830 II DW PCC GR 62P	Gray	Polycarbonate bowl/cover clear
910925866294	BDP100 LED50/830 II DS PCC GR 62P	Gray	Polycarbonate bowl/cover clear
910925866297	BDP100 LED70/830 II DS PCF GR 62P	Gray	Polycarbonate bowl/cover frosted
910925866302	BDP100 LED40/740 II DS PCC GR 62P	Gray	Polycarbonate bowl/cover clear
910925868060	BDP100 LED50/730 II DS PCC GR 62P	Gray	Polycarbonate bowl/cover frosted
910925868063	BDP100 LED50/730 II DW PCC GR 62P	Gray	Polycarbonate bowl/cover frosted

Order Code	Full Product Name	Housing Color	Optical cover type
910925868067	BDP100 LED70/730 II DW PCC GR 62P	Gray	Polycarbonate bowl/cover frosted
910925868095	BDP100 LED40/830 DS PCC ALU 76P	Silver	Polycarbonate bowl/cover frosted
910500991023	BDP102 LED50/830 II DS PCF SI CLO-DDF1 6	Silver	Polycarbonate bowl/cover frosted
910500991088	BDP102 LED60/740 II DS PCC SI LS-6 62P	Silver	Polycarbonate bowl/cover clear
910500991091	BDP102 LED60/740 II DS PCF SI LS-6 62P	Silver	Polycarbonate bowl/cover frosted
910500991092	BDP102 LED40/830 II DW PCC SI LS-6 62P	Silver	Polycarbonate bowl/cover clear
910500991098	BDP102 LED40/830 II DS PCC SI LS-6 62P	Silver	Polycarbonate bowl/cover clear
910500991101	BDP102 LED60/830 II DS PCC SI LS-6 62P	Silver	Polycarbonate bowl/cover clear
910500991128	BDP102 LED20/830 DW PCF SI CLO 62P	Silver	Polycarbonate bowl/cover frosted
910500991129	BDP102 LED30/830 DW PCF SI CLO 62P	Silver	Polycarbonate bowl/cover frosted
910500991130	BDP102 LED35/830 DW PCF SI CLO 62P	Silver	Polycarbonate bowl/cover frosted
910500991131	BDP102 LED50/830 DW PCF SI CLO 62P	Silver	Polycarbonate bowl/cover frosted
910500991132	BDP102 LED70/830 DW PCF SI CLO 62P	Silver	Polycarbonate bowl/cover frosted
910500991211	BDP102 LED50/830 DM PCC GR MSP 62P	Gray	Polycarbonate bowl/cover clear
910500991222	BDP102 LED35/830 II DW PCF SI LS-8 62P	Silver	Polycarbonate bowl/cover frosted
910500991224	BDP102 LED60/830 II DW PCF SI LS-8 62P	Silver	Polycarbonate bowl/cover frosted
910500991232	BDP102 LED40/830 II DM PCF SI 6 62P	Silver	Polycarbonate bowl/cover frosted
910500991233	BDP102 LED40/740 II DM PCF SI 6 62P	Silver	Polycarbonate bowl/cover frosted
910925863297	BDP102 LED70/740 DRW PCC GR D9 62P	Gray	Polycarbonate bowl/cover clear

Product Data

Order Code	Full Product Name	Product family code
910500991230	BDP101 LED40/830 II DM PCF SI 6 62P	BDP101
910500991231	BDP101 LED40/740 II DM PCF SI 6 62P	BDP101
910925866274	BDP101 LED40/830 II DW PCC GR 62P	BDP101
910925866304	BDP101 LED40/740 II DS PCC GR MSP 62P	BDP101
910500991147	BDP104 LED50/830 DW PCF SI CLO 62P	BDP104
910925863302	BDP104 LED70/740 DRW PCC GR D9 62P	BDP104
910925866625	BDP105 LED50/830 II DW PCC GR 62P	BDP105
910925866627	BDP105 LED70/830 II DS PCC GR 62P	BDP105
910500991138	BDP103 LED35/830 DW PCF SI CLO 62P	BDP103
910500991142	BDP103 LED120/830 DW PCF SI CLO 62P	BDP103
910925866471	BDP103 LED15/740 II DRW PCC GR 62P	BDP103
910925866472	BDP103 LED15/740 II DRW PCC GR 76P	BDP103
910925866473	BDP103 LED25/740 II DRW PCC GR 62P	BDP103
910925866474	BDP103 LED25/740 II DRW PCC GR 76P	BDP103
910925866624	BDP103 LED70/830 II DW PCC GR 62P	BDP103
910925868807	BDP103 LED30/740 II DS PCC BK CLO 76P	BDP103
910925868808	BDP103 LED50/740 II DS PCC BK CLO 76P	BDP103

Order Code	Full Product Name	Product family code
910925868809	BDP103 LED60/740 II DS PCC BK CLO 76P	BDP103
910925868810	BDP103 LED70/740 II DS PCC BK CLO 76P	BDP103
910500991010	BDP100 LED40/830 II DM PCC SI CLO-LS-6 6	BDP100
910500991064	BDP100 LED60/740 II DS PCC SI LS-6 62P	BDP100
910500991112	BDP100 LED20/830 DW PCF SI CLO 62P	BDP100
910500991015	BDP101 LED60/830 II DS PCF SI CLO-DDF2 6	BDP101
910500991014	BDP101 LED60/830 II DM PCC SI CLO-DDF2 6	BDP101
910500991021	BDP102 LED40/830 II DW PCC SI CLO-DDF1 6	BDP102
910500991082	BDP102 LED60/740 II DW PCC SI LS-6 62P	BDP102
910500991104	BDP102 LED60/830 II DS PCF SI LS-6 62P	BDP102
910500991136	BDP103 LED20/830 DW PCF SI CLO 62P	BDP103
910500991139	BDP103 LED50/830 DW PCF SI CLO 62P	BDP103
910500991024	BDP104 LED30/740 II DM PCC SI CLO-LS-8 6	BDP104
910500991009	BDP100 LED30/740 DN PCC SI CLO-LS-6 76P	BDP100
910500991067	BDP100 LED60/740 II DS PCF SI LS-6 62P	BDP100
910500991115	BDP100 LED50/830 DW PCF SI CLO 62P	BDP100
910500991117	BDP100 LED100/830 DW PCF SI CLO 62P	BDP100
910925452181	BDP100 LED40/740 DS PCC GR DDF27 62P	BDP100
910925863295	BDP100 LED70/740 DS PCC GR D9 62P	BDP100
910925866272	BDP100 LED40/830 II DW PCC GR 62P	BDP100
910925866276	BDP100 LED40/740 II DW PCC GR 62P	BDP100
910925866277	BDP100 LED50/740 II DW PCC GR 62P	BDP100
910925866278	BDP100 LED70/740 II DW PCC GR 62P	BDP100
910925866281	BDP100 LED70/740 II DW PCF GR 62P	BDP100
910925866282	BDP100 LED30/740 II DS PCC GR 62P	BDP100
910925866288	BDP100 LED50/830 II DW PCC GR 62P	BDP100
910925866289	BDP100 LED70/830 II DW PCC GR 62P	BDP100
910925866294	BDP100 LED50/830 II DS PCC GR 62P	BDP100
910925866297	BDP100 LED70/830 II DS PCF GR 62P	BDP100
910925866302	BDP100 LED40/740 II DS PCC GR 62P	BDP100
910925868060	BDP100 LED50/730 II DS PCC GR 62P	BDP100
910925868063	BDP100 LED50/730 II DW PCC GR 62P	BDP100
910925868067	BDP100 LED70/730 II DW PCC GR 62P	BDP100
910925868095	BDP100 LED40/830 DS PCC ALU 76P	BDP100
910500991023	BDP102 LED50/830 II DS PCF SI CLO-DDF1 6	BDP102
910500991088	BDP102 LED60/740 II DS PCC SI LS-6 62P	BDP102
910500991091	BDP102 LED60/740 II DS PCF SI LS-6 62P	BDP102
910500991092	BDP102 LED40/830 II DW PCC SI LS-6 62P	BDP102
910500991098	BDP102 LED40/830 II DS PCC SI LS-6 62P	BDP102
910500991101	BDP102 LED60/830 II DS PCC SI LS-6 62P	BDP102

Order Code	Full Product Name	Product family code
910500991128	BDP102 LED20/830 DW PCF SI CLO 62P	BDP102
910500991129	BDP102 LED30/830 DW PCF SI CLO 62P	BDP102
910500991130	BDP102 LED35/830 DW PCF SI CLO 62P	BDP102
910500991131	BDP102 LED50/830 DW PCF SI CLO 62P	BDP102
910500991132	BDP102 LED70/830 DW PCF SI CLO 62P	BDP102
910500991211	BDP102 LED50/830 DM PCC GR MSP 62P	BDP102
910500991222	BDP102 LED35/830 II DW PCF SI LS-8 62P	BDP102
910500991224	BDP102 LED60/830 II DW PCF SI LS-8 62P	BDP102
910500991232	BDP102 LED40/830 II DM PCF SI 6 62P	BDP102
910500991233	BDP102 LED40/740 II DM PCF SI 6 62P	BDP102
910925863297	BDP102 LED70/740 DRW PCC GR D9 62P	BDP102

Polar normal diagrams

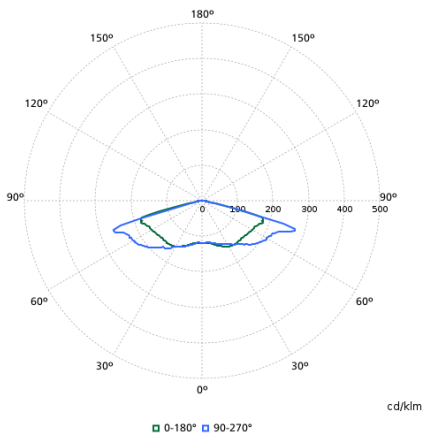

BDP1001 - 910500991064

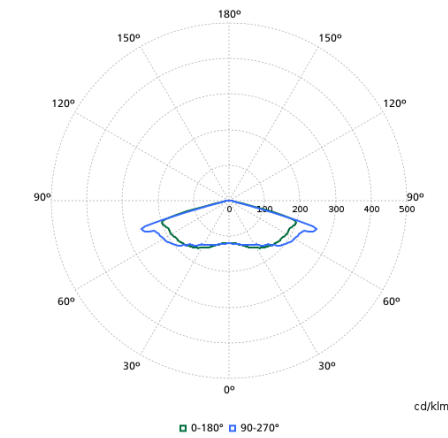

BDP1001 - 910500991074

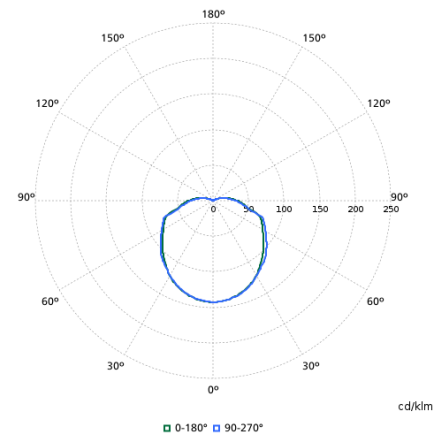

BDP1001 - 910500991104

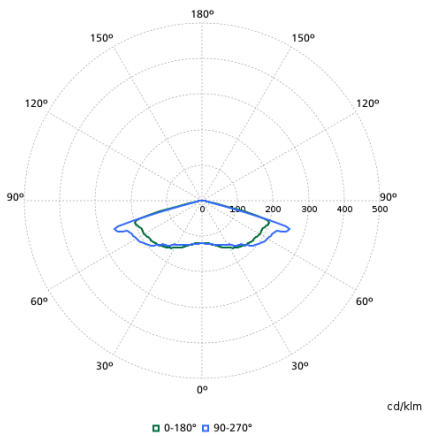

BDP1001 - 910500991062

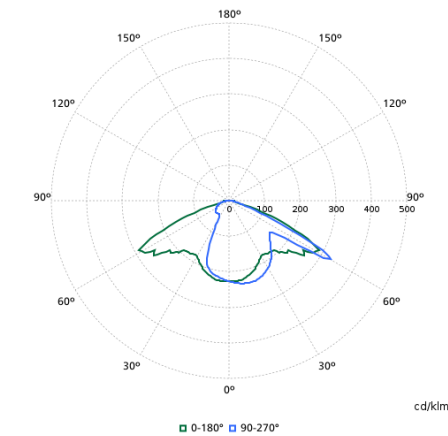

BDP1001 - 910500991082

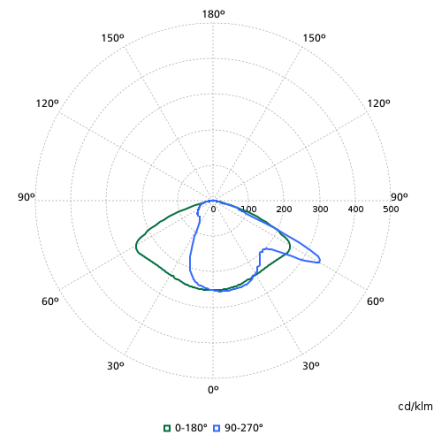

BDP1001 - 910500991069

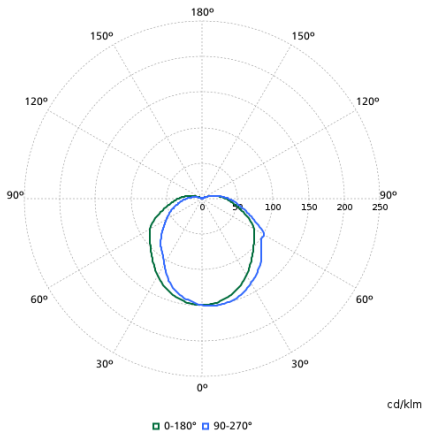

BDP100I - 910500991097

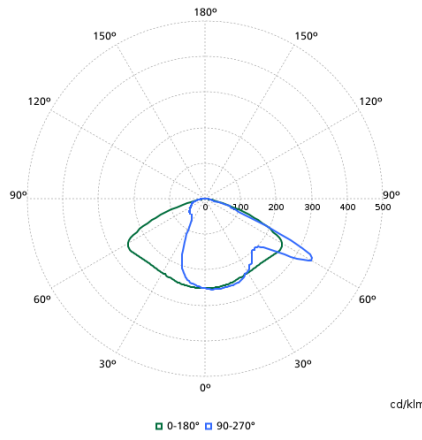

BDP100I - 910500991057

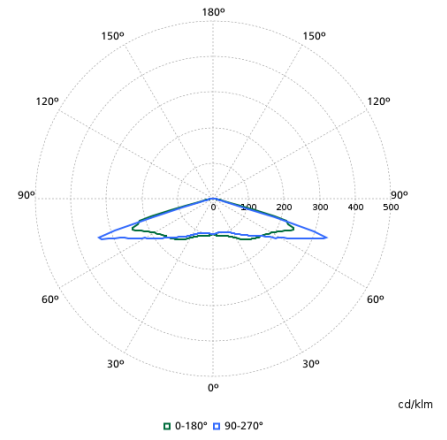

BDP100I - 910500991098

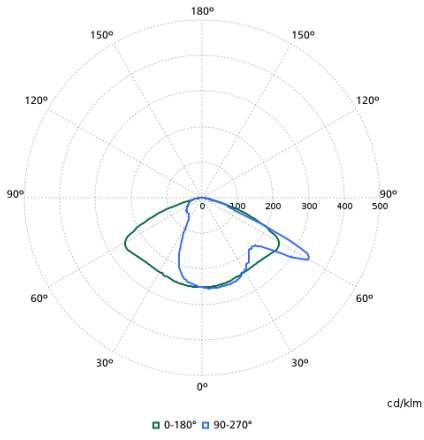

BDP100I - 910500991068

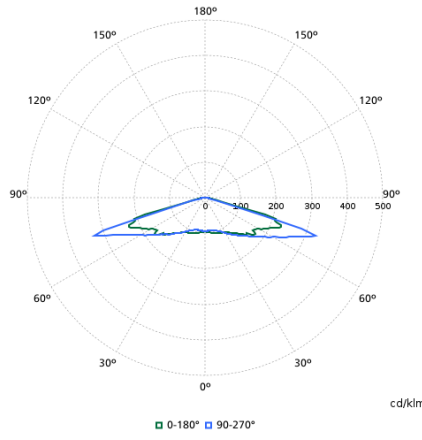

BDP100I - 910500991101

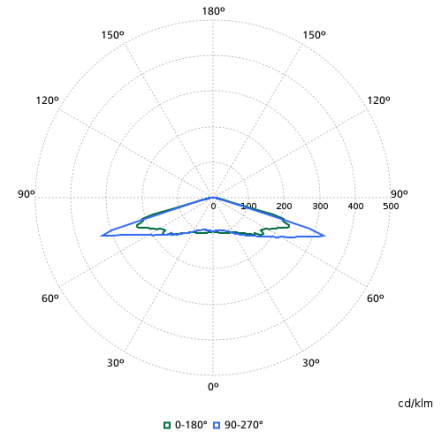

BDP100I - 910500991088

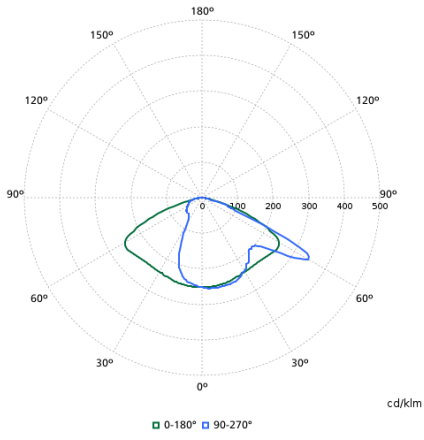

BDP100I - 910500991056

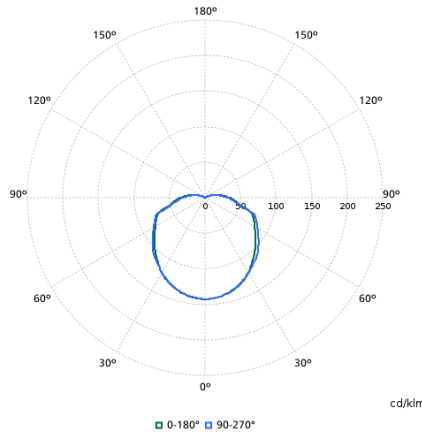

BDP100I - 910500991091

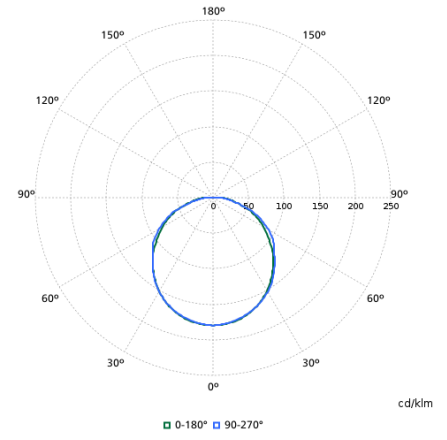

BDP100I - 910500991067

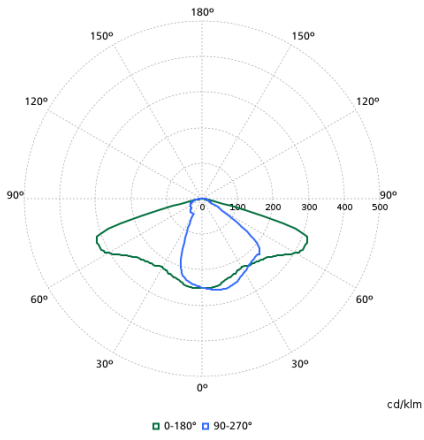

BDP100I - 910500991211

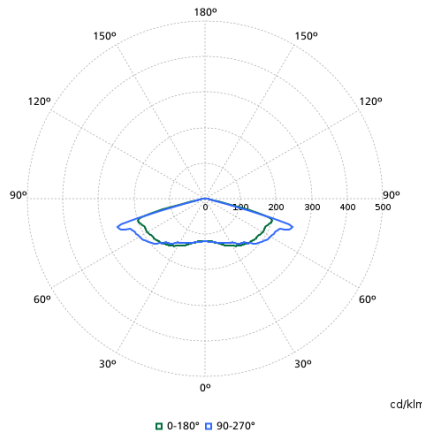

BDP100I - 910500991075

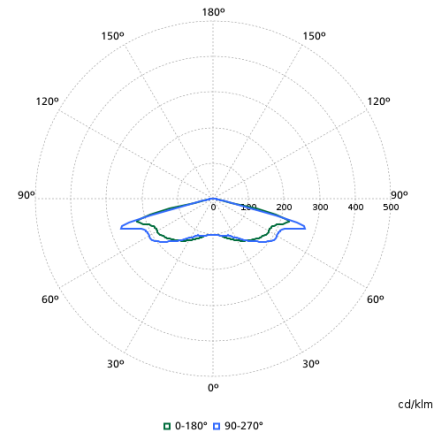

BDP100I - 910925866304

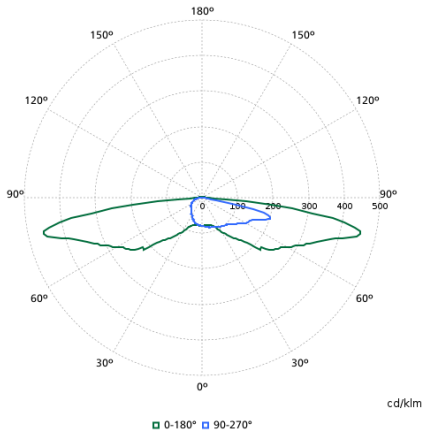

BDP100I - 910925863297

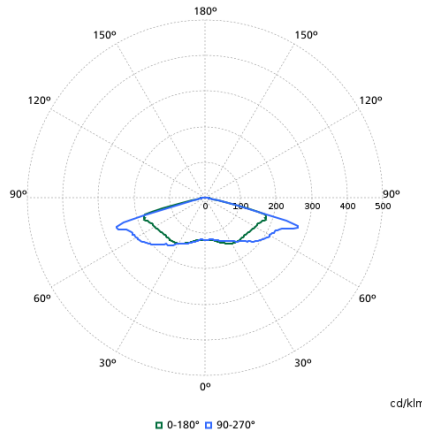

BDP100I - 910925863295

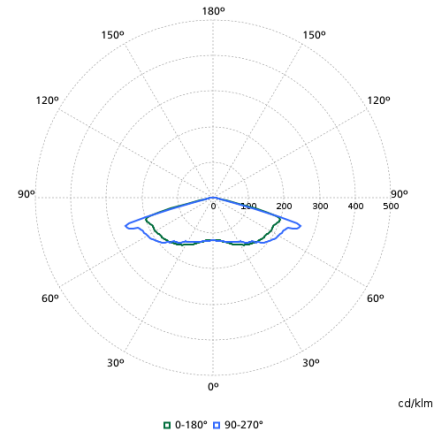

BDP100I - 910925866282

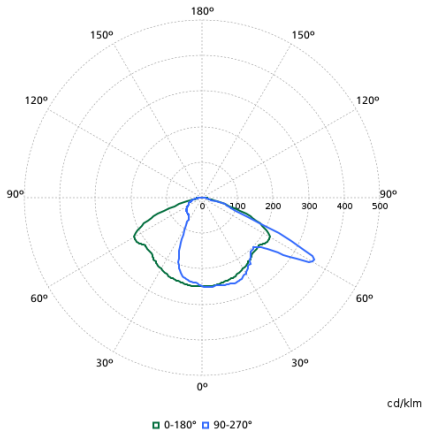

BDP100I - 910925866289

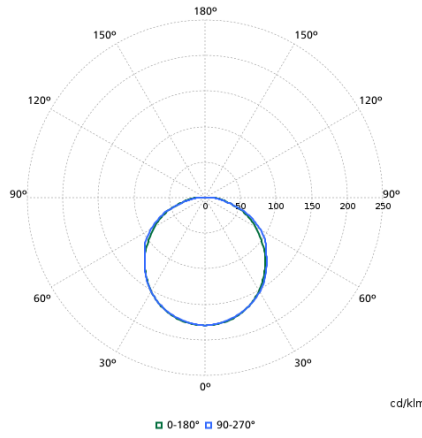

BDP100I - 910925866297

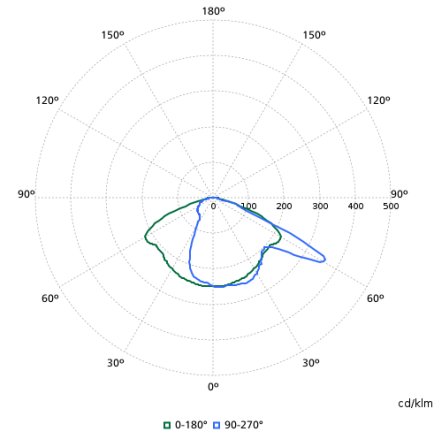

BDP100I - 910925866278

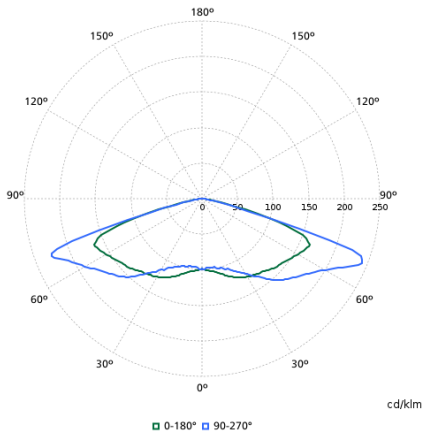

BDP100I - 91092586627

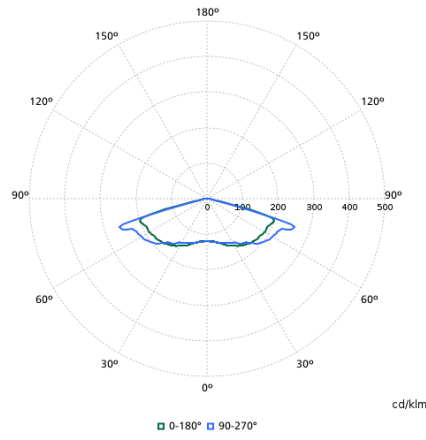

BDP100I - 910925868116

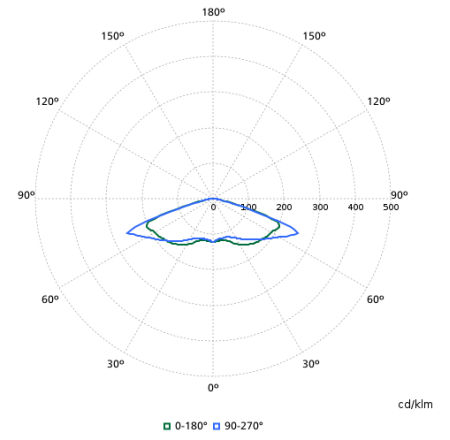

BDP100I - 910925868808

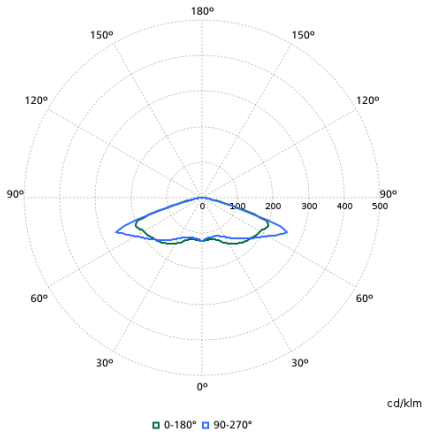

BDP100I - 910925868807

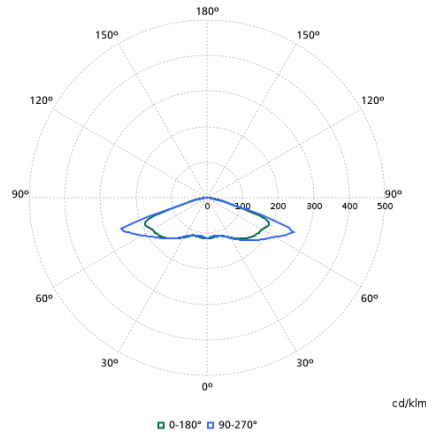

BDP100I - 910925868810

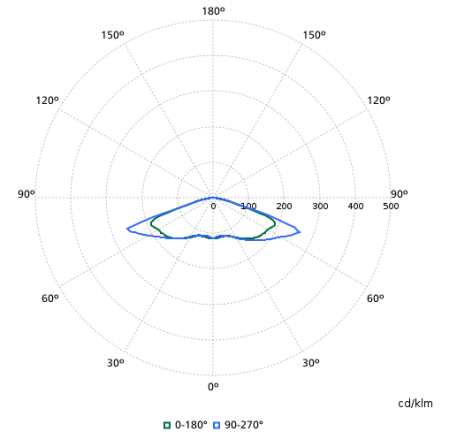

BDP100I - 910925868809

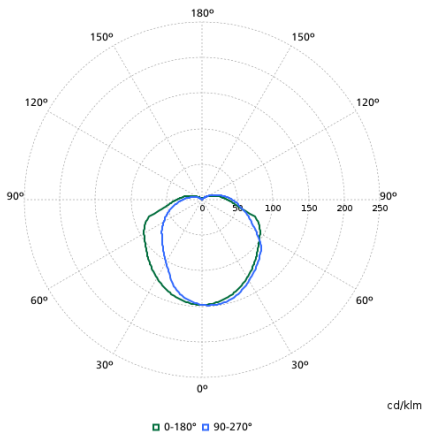

BDP100I - 910500991231

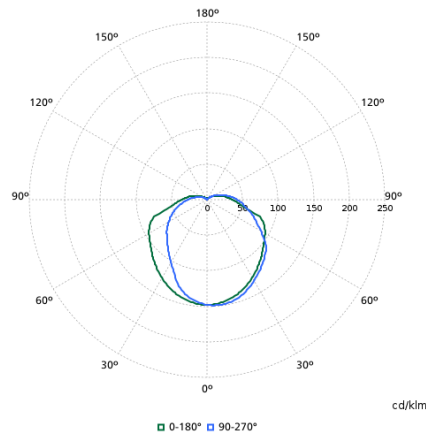

BDP100I - 910500991230

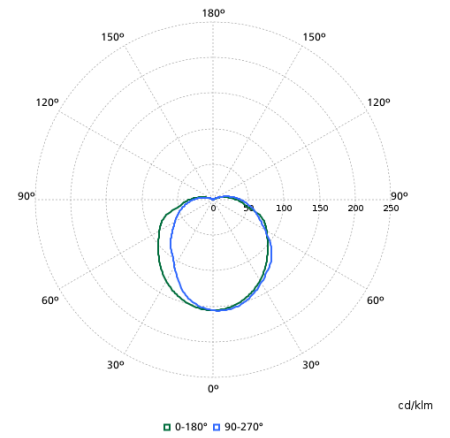

BDP100I - 910500991232

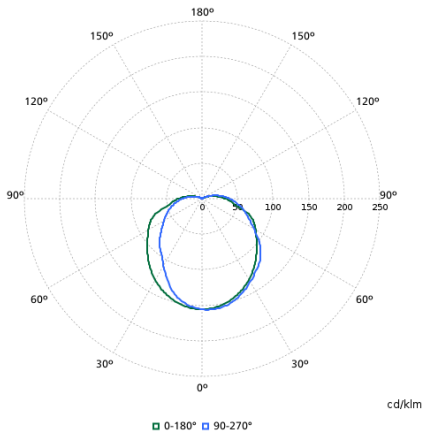

BDP1001 - 910500991233

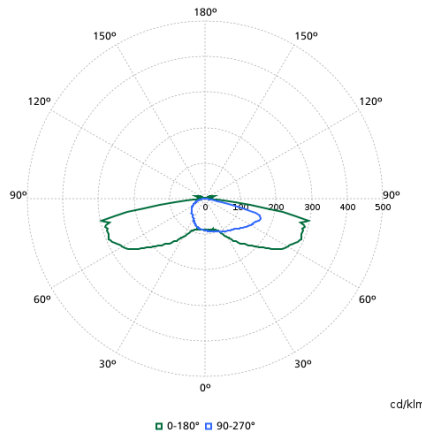

BDP1001 - 910925863302

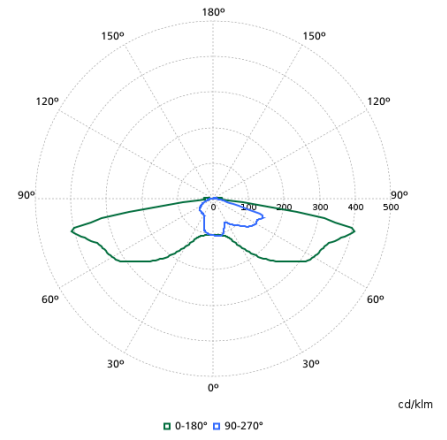

BDP1001 - 910925866472

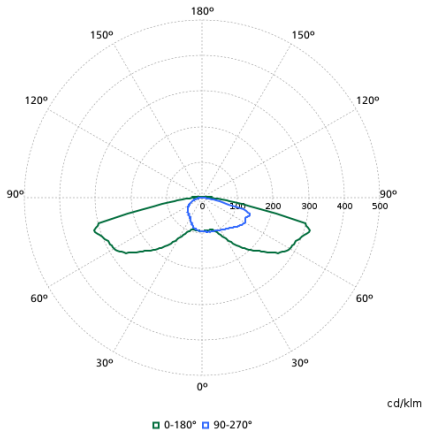

BDP1001 - 910925866473

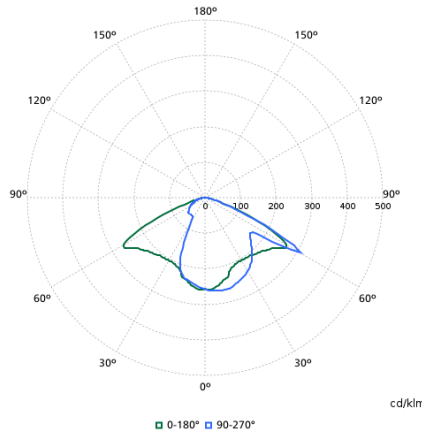

BDP1001 - 910925866624

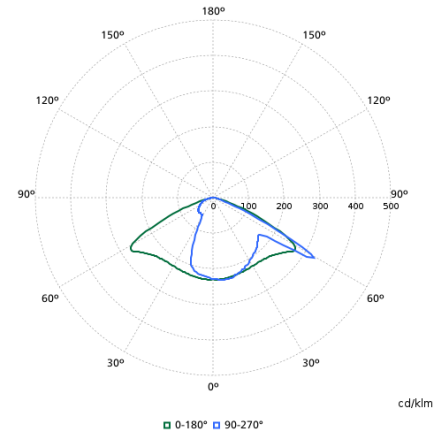

BDP1001 - 910925866625

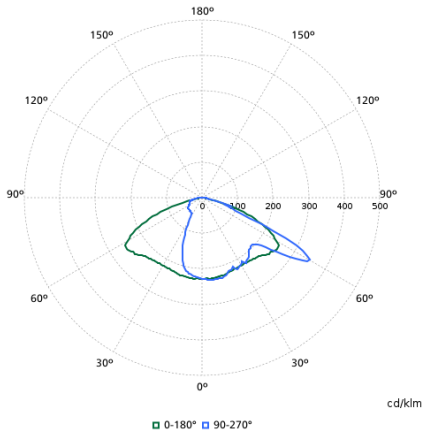

BDP1001 - 910925866274

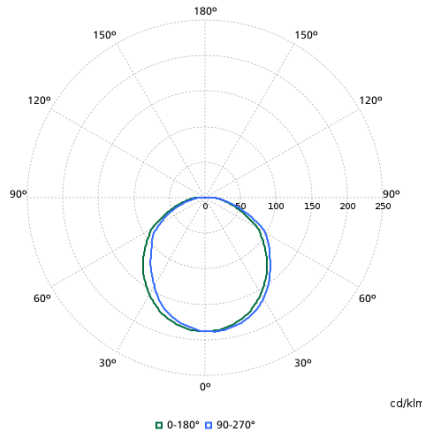

BDP1001 - 910925866281

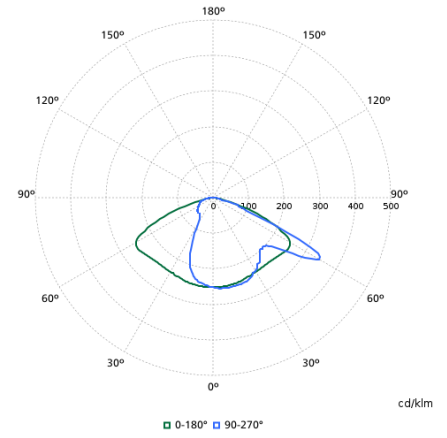

BDP1001 - 910925868063

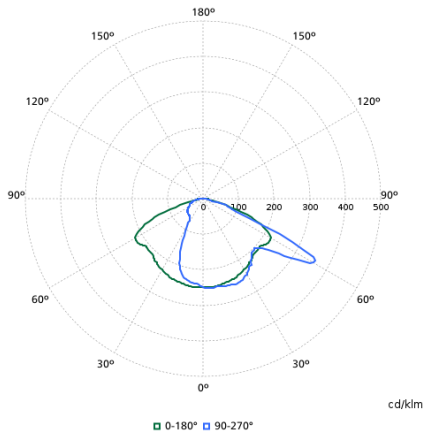

BDP100I - 910925868067

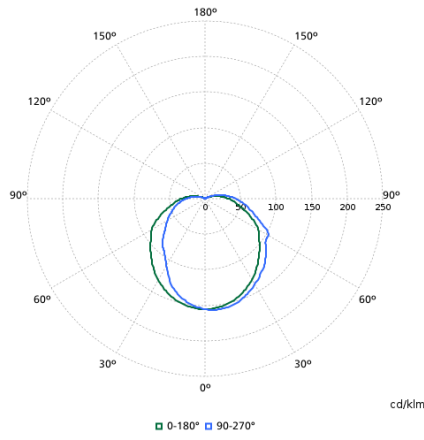

BDP100I - 910500991222

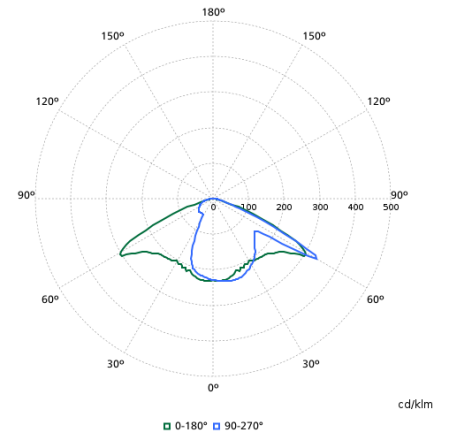

BDP100I - 910500991092