



Creating attractive inner-city landscapes

OptiSpace is a creative bollard solution which enables you to build a more attractive, citizen-centric inner-city space by avoiding verticalization of the urban landscape. OptiSpace delivers all this and more while delivering an attractive TCO for your investment. Enabled by the different control options you can reduce energy consumption and minimize TCO further and thanks to the excellent and optimized light distribution options you can maximize spacing between the bollards, thereby minimizing the number of light points needed to be installed. To support different design schemes, OptiSpace is also available in different colors: Ultra Dark Grey is the standard color and other colors are available on request.

Benefits

- Discreet design nicely blending into modern inner-city spaces
- Attractive Total Cost of Ownership
- Compliant with key national and international regulation in Europe

Applications

- Parks and plazas
- Pedestrian and cycle paths
- Building fronts and car parks

Features

- Enabling wide spacing, up to 20 meters
- Delivering up to 4300 lm light output
- IP66 and IK10 ratings

- Warm White (WW) / Neutral White (NW) color temperature options
- Choice of both asymmetric and symmetric optics
- Ground section accessory

Versions



OptiSpace-BCB500

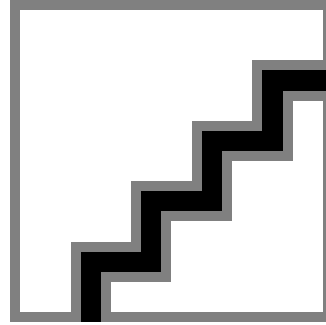

OptiSpace-BCB500 ANB

Dimensional drawing



OPTISPACE BOLLARD - LED module 2700 lm



OPTISPACE BOLLARD - LED module 2700 lm

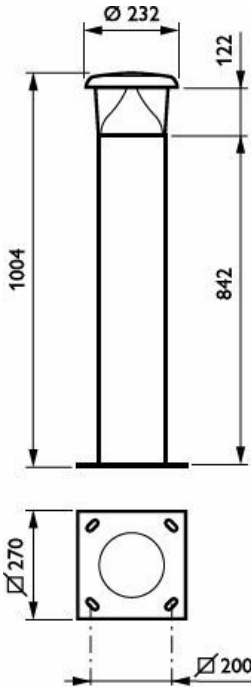

OPTISPACE BOLLARD - LED module 2700 lm



OPTISPACE BOLLARD - LED module 2700 lm



OPTISPACE BOLLARD - LED module 2700 lm



OPTISPACE BOLLARD - LED module 2700 lm

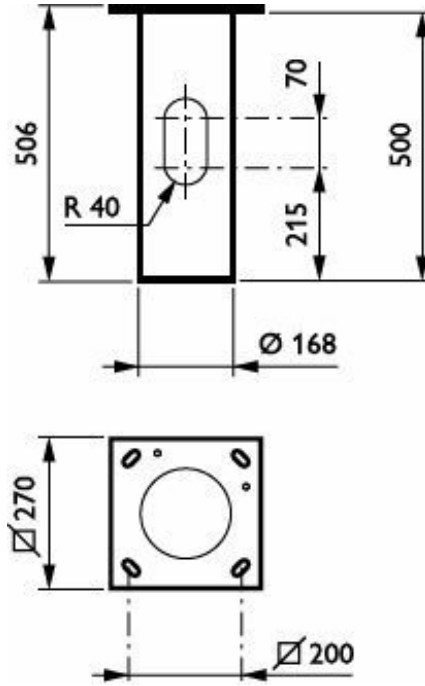

OPTISPACE BOLLARD - LED module 2700 lm

OptiSpace



OPTISPACE BOLLARD - LED module 2700 lm



OPTISPACE BOLLARD - LED module 2700 lm

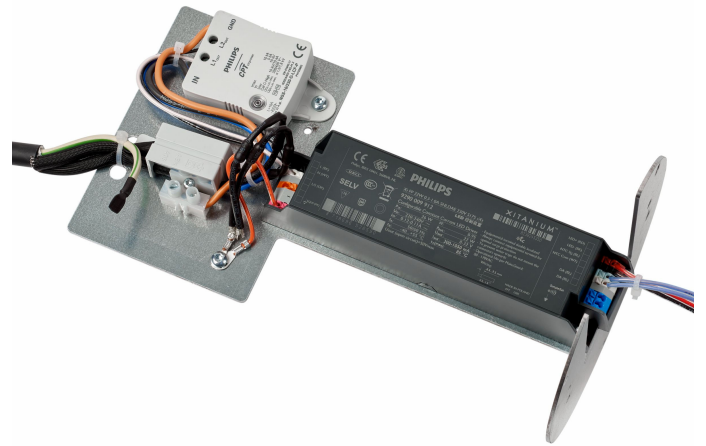

OPTISPACE BOLLARD - LED module 2700 lm

OPTISPACE BOLLARD - LED module 2700 lm

Product details



OptiSpace-BCB500
-5DPP.TIF



OptiSpace-BCB500
-1DPP.TIF



OptiSpace-BCB500
-9DPP.TIF

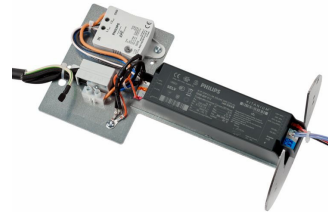

OptiSpace-BCB500
-7DPP.TIF



OptiSpace-BCB500
-2DPP.TIF



OptiSpace-BCB500
-3DPP.TIF



OptiSpace-BCB500
-4DPP.TIF



OptiSpace Sparepart



OptiSpace-BCB500
-6DPP.TIF



OptiSpace-BCB500
-10DPP.TIF

General Information

Light source replaceable	Yes
Number of gear units	1 unit
Driver included	Yes
Service tag	Yes

Light Technical

Upward light output ratio	0
Correlated Color Temperature (Nom)	4000 K
Color rendering index (CRI)	70
Light source color	740 neutral white

Operating and Electrical

Surge Protection (Common/ Differential)	Surge protection level until 6 kV differential mode and 6 kV common mode
--------------------------------------------	--------------------------------------------------------------------------------

Controls and Dimming

Dimmable No

Mechanical and Housing

Housing Color Black
Ingress protection code IP66 [Dust penetration-protected, jet-proof]
Mech. impact protection code IK10 [20 J vandal-resistant]
Standard tilt angle side entry 0°

Approval and Application

Flammability mark For mounting on normally flammable surfaces
CE mark Yes

Over Time Performance (IEC Compliant)

Driver failure rate at 5000 h 0.5 %

Product Data

Product family code BCB500 [OPTISPACE BOLLARD]

General Information

Order Code	Full Product Name	Lamp family code
48118600	BCB500 LED56-4S/740 S DGR	LED56
48120900	BCB500 LED27-4S/740 ANB14 II A DGR	LED27
04187500	BCB500 LED16-4S/740 PSU II S DGR MSP CLO	LED16

Light Technical

Order Code	Full Product Name	Luminous Flux	Luminaire light beam spread	Optic type outdoor
48118600	BCB500 LED56-4S/740 S DGR	4,900 lm	177°	Symmetrical
48120900	BCB500 LED27-4S/740 ANB14 II A DGR	2,400 lm	7° - 9° x 177°	Asymmetrical
04187500	BCB500 LED16-4S/740 PSU II S DGR MSP CLO	1,432 lm	177°	Symmetrical

Operating and Electrical

Order Code	Full Product Name	Power Consumption
48118600	BCB500 LED56-4S/740 S DGR	37.2 W
48120900	BCB500 LED27-4S/740 ANB14 II A DGR	20 W
04187500	BCB500 LED16-4S/740 PSU II S DGR MSP CLO	11.3 W

Mechanical and Housing

Order Code	Full Product Name	Standard tilt angle posttop	Optical cover type
48118600	BCB500 LED56-4S/740 S DGR	0°	Polycarbonate cover and gloss high-reflective optic
48120900	BCB500 LED27-4S/740 ANB14 II A DGR	0°	Polycarbonate cover and gloss high-reflective optic
04187500	BCB500 LED16-4S/740 PSU II S DGR MSP CLO -		Polycarbonate bowl/cover clear

Polar normal diagrams

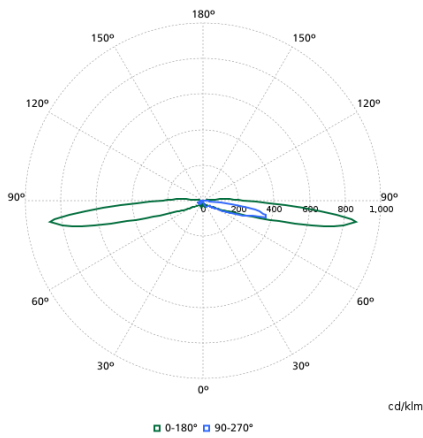

BCB500I - 912300024103

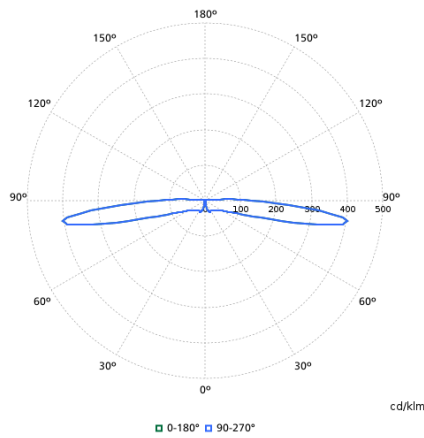

BCB500I - 912300024101