



## Creating attractive inner-city landscapes

OptiSpace is a creative bollard solution which enables you to build a more attractive, citizen-centric inner-city space by avoiding verticalization of the urban landscape. OptiSpace delivers all this and more while delivering an attractive TCO for your investment. Enabled by the different control options you can reduce energy consumption and minimize TCO further and thanks to the excellent and optimized light distribution options you can maximize spacing between the bollards, thereby minimizing the number of light points needed to be installed. To support different design schemes, OptiSpace is also available in different colors: Ultra Dark Grey is the standard color and other colors are available on request.

### Benefits

- Discreet design nicely blending into modern inner-city spaces
- Attractive Total Cost of Ownership
- Compliant with key national and international regulation in Europe

### Applications

- Parks and plazas
- Pedestrian and cycle paths
- Building fronts and car parks

## Features

- Enabling wide spacing, up to 20 meters
- Delivering up to 4300 lm light output
- IP66 and IK10 ratings

- Warm White (WW) / Neutral White (NW ) color temperature options
- Choice of both asymmetric and symmetric optics
- Ground section accessory

## Versions



OptiSpace-BCB500

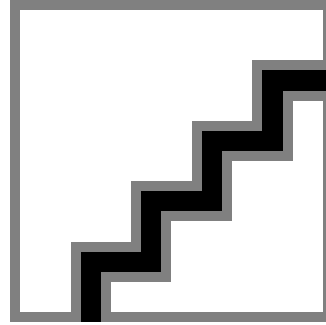

OptiSpace-BCB500 ANB

## Dimensional drawing



OPTISPACE BOLLARD - LED module 5600 lm



OPTISPACE BOLLARD - LED module 5600 lm

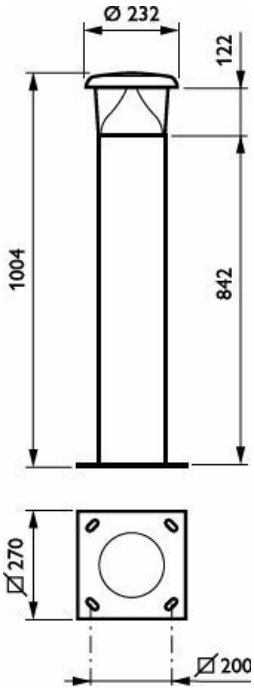

OPTISPACE BOLLARD - LED module 5600 lm



OPTISPACE BOLLARD - LED module 5600 lm



OPTISPACE BOLLARD - LED module 5600 lm



OPTISPACE BOLLARD - LED module 5600 lm

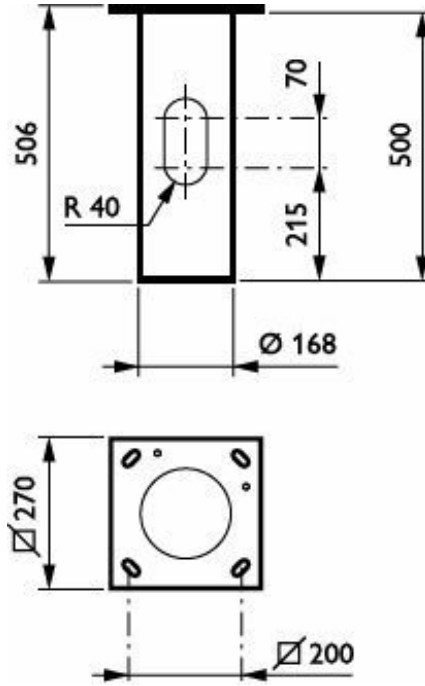

OPTISPACE BOLLARD - LED module 5600 lm

OptiSpace



OPTISPACE BOLLARD - LED module 5600 lm



OPTISPACE BOLLARD - LED module 5600 lm

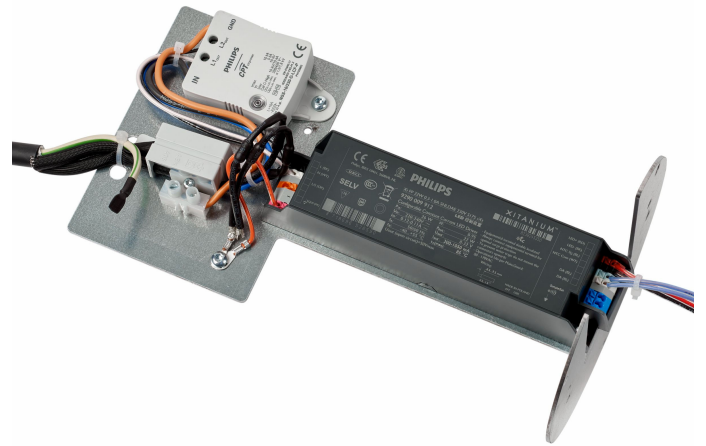

OPTISPACE BOLLARD - LED module 5600 lm

OPTISPACE BOLLARD - LED module 5600 lm

### Product details



OptiSpace-BCB500  
-5DPP.TIF



OptiSpace-BCB500  
-1DPP.TIF



OptiSpace-BCB500  
-9DPP.TIF

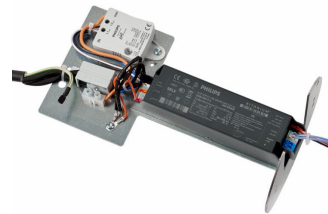

OptiSpace-BCB500  
-7DPP.TIF



OptiSpace-BCB500  
-2DPP.TIF



OptiSpace-BCB500  
-3DPP.TIF



OptiSpace-BCB500  
-4DPP.TIF



OptiSpace Sparepart



OptiSpace-BCB500  
-6DPP.TIF



OptiSpace-BCB500  
-10DPP.TIF

### General Information

Light source replaceable	Yes
Number of gear units	1 unit
Driver included	Yes
Service tag	Yes

### Light Technical

Upward light output ratio	0
---------------------------	---

### Operating and Electrical

Surge Protection (Common/Differential)	Surge protection level until 6 kV differential mode and 6 kV common mode
--	--

### Controls and Dimming

Dimmable	No
----------	----

## Mechanical and Housing

Housing Color	Black
Ingress protection code	IP66 [Dust penetration-protected, jet-proof]
Mech. impact protection code	IK10 [20 J vandal-resistant]
Standard tilt angle side entry	0°

## Approval and Application

Flammability mark	For mounting on normally flammable surfaces
CE mark	Yes

## Over Time Performance (IEC Compliant)

Driver failure rate at 5000 h	0.5 %
-------------------------------	-------

## Product Data

Product family code	BCB500 [OPTISPACE BOLLARD]
---------------------	----------------------------

## General Information

Order Code	Full Product Name	Lamp family code
912300024101	BCB500 LED56-4S/740 S DGR	LED56
912300024102	BCB500 LED56-4S/740 ANB14 II S DGR	LED56
912300024103	BCB500 LED27-4S/740 ANB14 II A DGR	LED27
912300060278	BCB500 LED16-4S/740 PSU II A DGR MSP CLO	LED16
912300060279	BCB500 LED16-4S/830 PSU II A DGR MSP CLO	LED16
912300060280	BCB500 LED16-4S/740 PSU II S DGR MSP CLO	LED16
912300060281	BCB500 LED16-4S/830 PSU II S DGR MSP CLO	LED16
912300060282	BCB500 LED10-4S/740 PSU II A DGR MSP CLO	LED10
912300060283	BCB500 LED10-4S/830 PSU II A DGR MSP CLO	LED10

## Light Technical

Order Code	Full Product Name	Luminous Flux	Correlated Color Temperature (Nom)	Color rendering index (CRI)	Light source color	Luminaire light beam spread	Optic type outdoor
912300024101	BCB500 LED56-4S/740 S DGR	4,900 lm	4000 K	70	740 neutral white	177°	Symmetrical

Order Code	Full Product Name	Luminous Flux	Correlated Color Temperature (Nom)	Color rendering index (CRI)	Light source color	Luminaire light beam spread	Optic type outdoor
912300024102	BCB500 LED56-4S/740 ANB14 II S DGR	4,900 lm	4000 K	70	740 neutral white	177°	Symmetrical
912300024103	BCB500 LED27-4S/740 ANB14 II A DGR	2,400 lm	4000 K	70	740 neutral white	7° - 9° x 177°	Asymmetrical
912300060278	BCB500 LED16-4S/740 PSU II A DGR MSP CLO	1,450 lm	4000 K	70	740 neutral white	21° - 26° x 200°	Asymmetrical
912300060279	BCB500 LED16-4S/830 PSU II A DGR MSP CLO	1,420 lm	3000 K	80	830 warm white	21° - 26° x 200°	Asymmetrical
912300060280	BCB500 LED16-4S/740 PSU II S DGR MSP CLO	1,432 lm	4000 K	70	740 neutral white	177°	Symmetrical
912300060281	BCB500 LED16-4S/830 PSU II S DGR MSP CLO	1,390 lm	3000 K	80	830 warm white	177°	Symmetrical
912300060282	BCB500 LED10-4S/740 PSU II A DGR MSP CLO	906 lm	4000 K	70	740 neutral white	21° - 26° x 200°	Asymmetrical
912300060283	BCB500 LED10-4S/830 PSU II A DGR MSP CLO	887 lm	3000 K	80	830 warm white	21° - 26° x 200°	Asymmetrical

## Operating and Electrical

Order Code	Full Product Name	Power Consumption
912300024101	BCB500 LED56-4S/740 S DGR	37.2 W
912300024102	BCB500 LED56-4S/740 ANB14 II S DGR	37.2 W
912300024103	BCB500 LED27-4S/740 ANB14 II A DGR	20 W
912300060278	BCB500 LED16-4S/740 PSU II A DGR MSP CLO	12.3 W
912300060279	BCB500 LED16-4S/830 PSU II A DGR MSP CLO	14.7 W
912300060280	BCB500 LED16-4S/740 PSU II S DGR MSP CLO	11.3 W
912300060281	BCB500 LED16-4S/830 PSU II S DGR MSP CLO	12.8 W
912300060282	BCB500 LED10-4S/740 PSU II A DGR MSP CLO	7.6 W
912300060283	BCB500 LED10-4S/830 PSU II A DGR MSP CLO	9.1 W

## Mechanical and Housing

Order Code	Full Product Name	Standard tilt angle posttop	Optical cover type
912300024101	BCB500 LED56-4S/740 S DGR	0°	Polycarbonate cover and gloss high-reflective optic
912300024102	BCB500 LED56-4S/740 ANB14 II S DGR	0°	Polycarbonate cover and gloss high-reflective optic
912300024103	BCB500 LED27-4S/740 ANB14 II A DGR	0°	Polycarbonate cover and gloss high-reflective optic
912300060278	BCB500 LED16-4S/740 PSU II A DGR MSP CLO	-	Polycarbonate bowl/cover clear
912300060279	BCB500 LED16-4S/830 PSU II A DGR MSP CLO	-	Polycarbonate bowl/cover clear
912300060280	BCB500 LED16-4S/740 PSU II S DGR MSP CLO	-	Polycarbonate bowl/cover clear
912300060281	BCB500 LED16-4S/830 PSU II S DGR MSP CLO	-	Polycarbonate bowl/cover clear

Order Code	Full Product Name	Standard tilt angle posttop	Optical cover type
912300060282	BCB500 LED10-4S/740 PSU II A DGR MSP CLO -	-	Polycarbonate bowl/cover clear
912300060283	BCB500 LED10-4S/830 PSU II A DGR MSP CLO -	-	Polycarbonate bowl/cover clear

## Polar normal diagrams

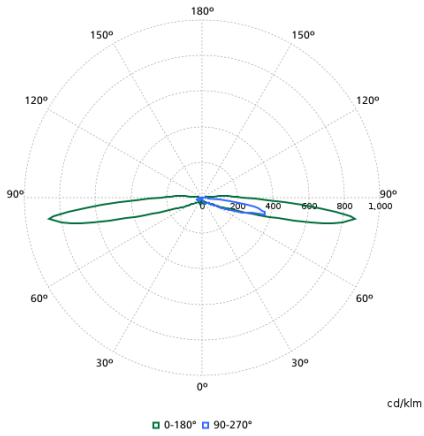

BCB500I - 912300024103

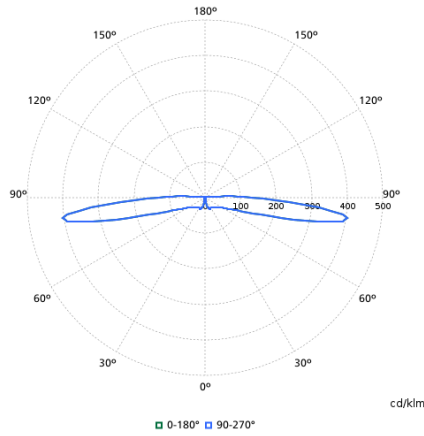

BCB500I - 912300024101

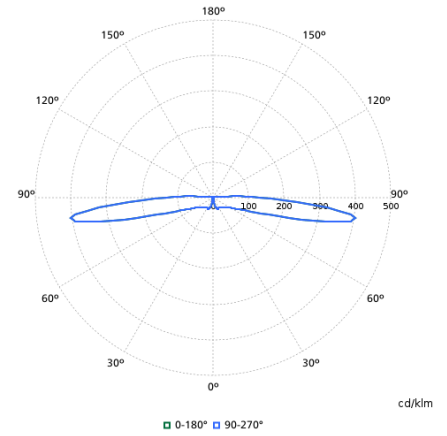

BCB500I - 912300024102