



## 3CCT LED product

### Essential SmartBright LED spot.

3CCT dip switch combines 3 color temperature into one lamp and targets retailers who want to keep portfolio on the shelf and the inventory in warehouse as less as possible and ensures end users buy right lamps.

#### Benefits

- Save cost for end users by reducing the chance to buy wrong products and offering 3 colors in one product
- Offer easy-to-operate features by switching the button to change the color

#### Features

- 3 color temperatures (3000K, 4000K, 6500K) in one lamp
- Easy to change the color by switching the button
- Eye comfort

#### Application

- Home application

#### Versions



LEDSpot 50W DS DIM MR16 12V  
60D 1PF 6 AU RTP



LEDPAR38 12W E27 DS FR ND  
IP65 1CT 6

# Essential SmartBright LED spot.

## Versions



LEDSpot 50W DS DIM GU10 60D  
1PF 6 AU RTP

## Dimensional drawing

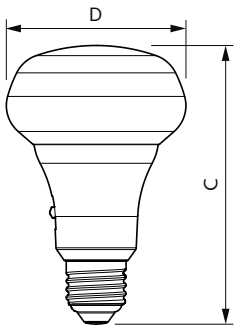

Product	D	C
LED80 14W E27 DS FR DIM 1CT/6	80 mm	122 mm
LED80 9W E27 DS FR DIM 1CT/6	80 mm	122 mm

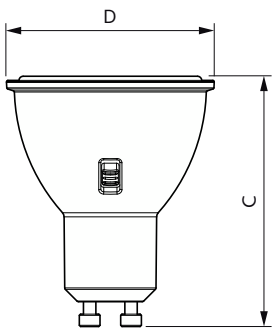

Product	D	C
LEDSpot 4.8W DS DIM GU10 60D 1PF/6 AU	50 mm	61 mm

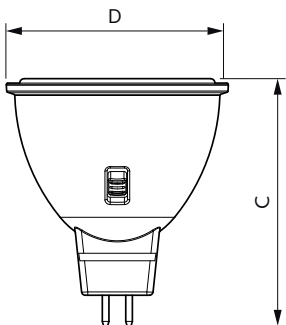

Product	D	C
LEDSpot 5W DS DIM MR16 12V 60D 1PF/6 AU	50 mm	57 mm

# Essential SmartBright LED spot.

## Dimensional drawing

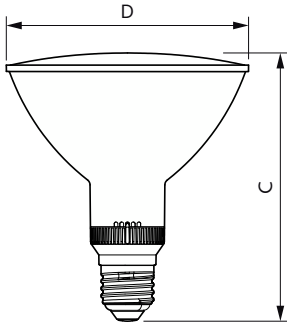

Product	D	C
LEDPAR38 12W E27 DS FR ND IP65 1CT/6	120 mm	133 mm
LEDPAR38 12W E27 DS FR ND IP65 2CT/3	120 mm	133 mm

General Information	
Switching Cycle	50,000
Nominal lifetime	15,000 hour(s)
Light Technical	
Color rendering index (CRI)	80
LLMF At End Of Nominal Lifetime (Nom)	70 %
Operating and Electrical	
Starting Time (Nom)	0.5 s
Approval and Application	
Ambient temperature range	-20 to +45 °C

## General Information

Order Code	Full Product Name	Cap-Base	Order Code	Full Product Name	Cap-Base
929003780419	LEDSpot 5W DS DIM MR16 12V 60D 1PF/6 AU	GU5.3	929004273319	LEDR80 9W E27 DS FR DIM 1CT/6	E27
929004273219	LEDPAR38 12W E27 DS FR ND IP65 1CT/6	E27	929004273419	LEDR80 14W E27 DS FR DIM 1CT/6	E27
929004273229	LEDPAR38 12W E27 DS FR ND IP65 2CT/3	E27	929003780319	LEDSpot 4.8W DS DIM GU10 60D 1PF/6 AU	GU10

## Light Technical

Order Code	Full Product Name	Beam Angle (Nom)	Correlated Color		Luminous Intensity (Nom)
			Temperature (Nom)	Color Code	
929003780419	LEDSpot 5W DS DIM MR16 12V 60D 1PF/6 AU	60 degree(s)	3000 K	3000/4000/6500	500 lm 450 cd
929004273219	LEDPAR38 12W E27 DS FR ND IP65 1CT/6	100 degree(s)	2700 K	2700K/3000K/4000K/5000K/6500K	1,200 lm -
929004273229	LEDPAR38 12W E27 DS FR ND IP65 2CT/3	100 degree(s)	2700 K	2700K/3000K/4000K/5000K/6500K	1,200 lm -
929004273319	LEDR80 9W E27 DS FR DIM 1CT/6	120 degree(s)	2700 K	2700K/3000K/4000K/5000K/6500K	950 lm -
929004273419	LEDR80 14W E27 DS FR DIM 1CT/6	120 degree(s)	2700 K	2700K/3000K/4000K/5000K/6500K	1,400 lm -
929003780319	LEDSpot 4.8W DS DIM GU10 60D 1PF/6 AU	60 degree(s)	3000 K	3000/4000/6500	500 lm 450 cd

## Operating and Electrical

## Essential SmartBright LED spot.

Order Code	Full Product Name	Input	Power	Wattage
		Frequency	Consumption	Equivalent
929003780419	LEDSpot 5W DS DIM MR16 12V 60D 1PF/6 AU	- Hz	5 W	50 W
929004273219	LEDPAR38 12W E27 DS FR ND IP65 1CT/6	50 to 60 Hz	12 W	120 W
929004273229	LEDPAR38 12W E27 DS FR ND IP65 2CT/3	50 to 60 Hz	12 W	120 W

Order Code	Full Product Name	Input	Power	Wattage
		Frequency	Consumption	Equivalent
929004273319	LEDR80 9W E27 DS FR DIM 1CT/6	50 to 60 Hz	9 W	60 W
929004273419	LEDR80 14W E27 DS FR DIM 1CT/6	50 to 60 Hz	14 W	95 W
929003780319	LEDSpot 4.8W DS DIM GU10 60D 1PF/6 AU	50 to 60 Hz	4.8 W	50 W

### Temperature

Order Code	Full Product Name	T-Case Maximum (Nom)
929003780419	LEDSpot 5W DS DIM MR16 12V 60D 1PF/6 AU	70 °C
929004273219	LEDPAR38 12W E27 DS FR ND IP65 1CT/6	65 °C
929004273229	LEDPAR38 12W E27 DS FR ND IP65 2CT/3	65 °C

Order Code	Full Product Name	T-Case Maximum (Nom)
929004273319	LEDR80 9W E27 DS FR DIM 1CT/6	90 °C
929004273419	LEDR80 14W E27 DS FR DIM 1CT/6	95 °C
929003780319	LEDSpot 4.8W DS DIM GU10 60D 1PF/6 AU	60 °C

### Controls and Dimming

Order Code	Full Product Name	Dimmable
929003780419	LEDSpot 5W DS DIM MR16 12V 60D 1PF/6 AU	Only with specific dimmers
929004273219	LEDPAR38 12W E27 DS FR ND IP65 1CT/6	No
929004273229	LEDPAR38 12W E27 DS FR ND IP65 2CT/3	No
929004273319	LEDR80 9W E27 DS FR DIM 1CT/6	Only with specific dimmers

Order Code	Full Product Name	Dimmable
929004273419	LEDR80 14W E27 DS FR DIM 1CT/6	Only with specific dimmers
929003780319	LEDSpot 4.8W DS DIM GU10 60D 1PF/6 AU	Only with specific dimmers

### Mechanical and Housing

Order Code	Full Product Name	Bulb Finish	Bulb Shape
929003780419	LEDSpot 5W DS DIM MR16 12V 60D 1PF/6 AU	Clear	MR16
929004273219	LEDPAR38 12W E27 DS FR ND IP65 1CT/6	Clear	PAR38
929004273229	LEDPAR38 12W E27 DS FR ND IP65 2CT/3	Clear	PAR38
929004273319	LEDR80 9W E27 DS FR DIM 1CT/6	Frosted	R80
929004273419	LEDR80 14W E27 DS FR DIM 1CT/6	Frosted	R80
929003780319	LEDSpot 4.8W DS DIM GU10 60D 1PF/6 AU	Clear	PAR16

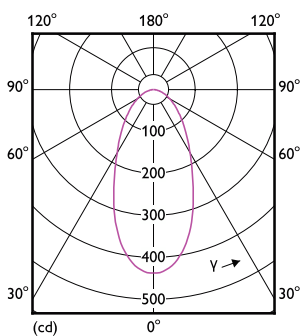
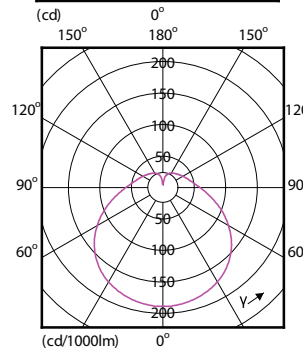
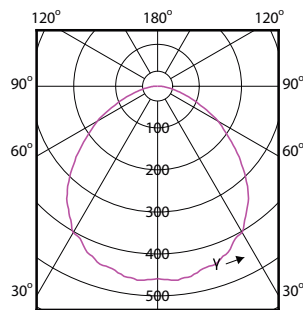

# Essential SmartBright LED spot.

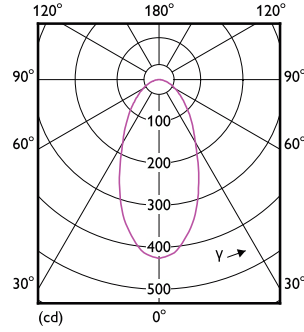
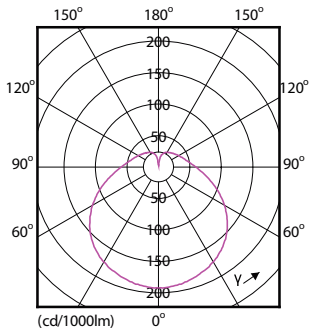

## Accent Diagrams

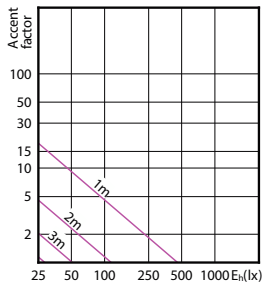

Accent Diagram - LEDPAR38 12W E27 DS FR ND IP65 1CT/6

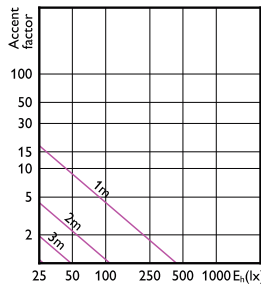

Accent Diagram - LEDSpot 5W DS DIM MR16 12V 60D 1PF/6 AU

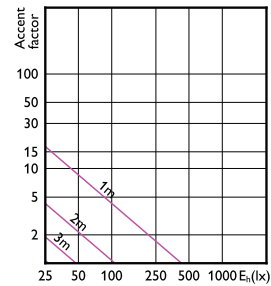

Accent Diagram - LEDSpot 4.8W DS DIM GU10 60D 1PF/6 AU

## Beam Diagrams

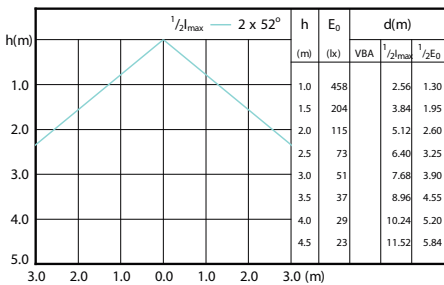

Beam diagram - LEDPAR38 12W E27 DS FR ND IP65 1CT/6

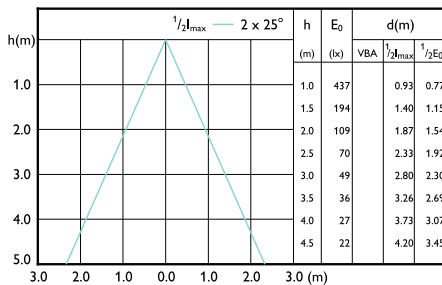

Beam diagram - LEDSpot 5W DS DIM MR16 12V 60D 1PF/6 AU

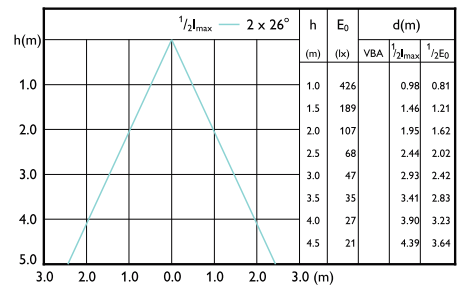

Beam diagram - LEDSpot 4.8W DS DIM GU10 60D 1PF/6 AU

