



Lampade LED oliva e sfera con flusso luminoso regolabile offrono una illuminazione non solo funzionale ma in grado di creare la giusta atmosfera in applicazione domestica e nel settore ricettivo

Lampadine a oliva e sferiche LED MASTER in vetro

Caratterizzate da un design tradizionale, le lampade a filamento LED combinano le forme classiche delle lampade incandescenza oliva e sfera con i vantaggi della tecnologia LED a lunga durata. È un prodotto ideale per fornire ai clienti un'atmosfera accogliente. Le lampade MASTER LED candela e sfera godono di un flusso luminoso regolabile con diversi livelli di emissione luminosa e anche con una diversa temperatura del colore. Le lampade MASTER LED candela e sfera consentono un notevole risparmio energetico offrendo addirittura il 30% in più

Lampadine a oliva e sferiche LED MASTER in vetro

rispetto alle lampade LED standard e forniscono un'eccellente qualità della luce. Grazie a una durata di 25.000 ore, consentono di ridurre i costi di manutenzione.

Vantaggi

- Risparmio energetico, 30% di energia in meno rispetto alle lampade oliva e sfera standard LED Philips
- Maggiore durata che riduce l'esigenza di sostituzione
- Sostituzione semplice delle lampade convenzionali

Caratteristiche

- Design tradizionale con forme classiche
- Adattabilità perfetta e finitura di alta qualità
- Qualità della luce ottimale con resa cromatica estremamente elevata (CRI>95)
- Progettate per essere notate, sia accese sia spente
- Rispetto dell'ambiente: senza mercurio o altre sostanze nocive

Applicazione

- Applicazione domestica
- Hotel, ristoranti e bar

Versions



LEDclassic 40W B35 E14 CL
WGD90 SRT4 1



LEDclassic 25W B35 E14 CL
WGD90 SRT4 1



LEDclassic 40W BA35 E14 CL
WGD90 SRT4 1



LEDclassic 40W P45 E27 CL
WGD90 SRT4 1

Lampadine a oliva e sferiche LED MASTER in vetro

Versions



LEDclassic 25W P45 E27 CL
WGD90 SRT4 1



LEDclassic 25W P45 E14 CL
WGD90 SRT4 1

Disegno tecnico

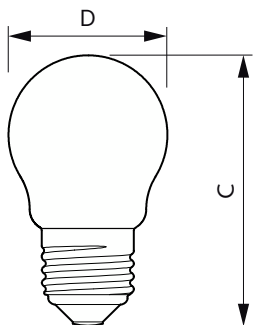
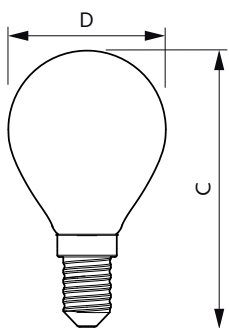
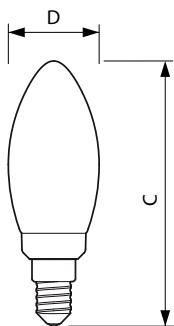

Product	D	C
MAS LEDCandleDT2.5-25W E14 B35 CL G	35 mm	97 mm
MAS LEDCandleDT3.4-40W E14 927 B35CL G	35 mm	97 mm
MAS LEDCandleDT5.9-60W E14 927 B35 CL G	35 mm	97 mm

Product	D	C
MAS LEDLusterDT2.5-25W E14 927 P45CL G	45 mm	80 mm
MAS LEDLusterDT3.4-40W E14 927 P45CL G	45 mm	80 mm
MAS LEDLusterDT5.9-60W E14 927 P45 CL G	45 mm	80 mm

Product	D	C
MAS LEDLusterDT2.5-25W E27 927 P45CL G	45 mm	78 mm
MAS LEDLusterDT3.5-40W E27 927 P45CL G	45 mm	78 mm

Lampadine a oliva e sferiche LED MASTER in vetro

Disegno tecnico

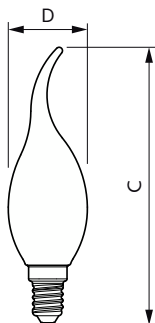

Product	D	C
MAS LEDCandleDT3.4-40W E14927 BA35CL G	35 mm	119 mm

Informazioni generali

Ciclo di commutazione on/off	20.000
Durata nominale	25.000 ore

Dati tecnici di illuminazione

Temperatura di colore correlata (Nom)	2200 K
Indice di resa cromatica (CRI)	90
Codice colore	922-927
LLMF a fine durata vita nominale (Nom)	70 %

Funzionamento e parte elettrica

Frequenza di ingresso	Da 50 a 60 Hz
Frequenza di linea	50 to 60 Hz
Tempo di avvio (Nom)	0,5 s

Temperatura

Temp. massima involucro (Nom)	70 °C
-------------------------------	-------

Controlli e dimmerazione

Dimmerabile	Solo con dimmer specifici
-------------	---------------------------

Meccanica e corpo

Finitura lampadina	Trasparente
--------------------	-------------

Approvazione e applicazione

Intervallo temperatura ambiente	Da -20 °C a 45 °C
---------------------------------	-------------------

Informazioni generali

Order Code	Full Product Name	Attacco
44941100	MAS LEDCandleDT3.4-40W E14 927 B35CL G	E14
44957200	MAS LEDCandleDT5.9-60W E14 927 B35 CL G	E14
44935000	MAS LEDCandleDT2.5-25W E14 B35 CL G	E14
44949700	MAS LEDCandleDT3.4-40W E14927 BA35CL G	E14
44953400	MAS LEDLusterDT3.5-40W E27 927 P45CL G	E27
44939800	MAS LEDLusterDT2.5-25W E27 927 P45CL G	E27
44937400	MAS LEDLusterDT2.5-25W E14 927 P45CL G	E14
44951000	MAS LEDLusterDT3.4-40W E14 927 P45CL G	E14
44961900	MAS LEDLusterDT5.9-60W E14 927 P45 CL G	E14

Dati tecnici di illuminazione

Order Code	Full Product Name	Flusso luminoso
44941100	MAS LEDCandleDT3.4-40W E14 927 B35CL G	470 lm
44957200	MAS LEDCandleDT5.9-60W E14 927 B35 CL G	806 lm
44935000	MAS LEDCandleDT2.5-25W E14 B35 CL G	340 lm
44949700	MAS LEDCandleDT3.4-40W E14927 BA35CL G	470 lm
44953400	MAS LEDLusterDT3.5-40W E27 927 P45CL G	470 lm

Order Code	Full Product Name	Flusso luminoso
44939800	MAS LEDLusterDT2.5-25W E27 927 P45CL G	340 lm
44937400	MAS LEDLusterDT2.5-25W E14 927 P45CL G	340 lm
44951000	MAS LEDLusterDT3.4-40W E14 927 P45CL G	470 lm
44961900	MAS LEDLusterDT5.9-60W E14 927 P45 CL G	806 lm

Funzionamento e parte elettrica

Lampadine a oliva e sferiche LED MASTER in vetro

Order Code	Full Product Name	Consumo energetico	Potenza equivalente
44941100	MAS LEDCandleDT3.4-40W E14 927 B35CL G	3,4 W	40 W
44957200	MAS LEDCandleDT5.9-60W E14 927 B35 CL G	5,9 W	60 W
44935000	MAS LEDCandleDT2.5-25W E14 B35 CL G	2,5 W	25 W
44949700	MAS LEDCandleDT3.4-40W E14927 BA35CL G	3,4 W	40 W
44953400	MAS LEDLusterDT3.5-40W E27 927 P45CL G	3,4 W	40 W

Order Code	Full Product Name	Consumo energetico	Potenza equivalente
44939800	MAS LEDLusterDT2.5-25W E27 927 P45CL G	2,5 W	25 W
44937400	MAS LEDLusterDT2.5-25W E14 927 P45CL G	2,5 W	25 W
44951000	MAS LEDLusterDT3.4-40W E14 927 P45CL G	3,4 W	40 W
44961900	MAS LEDLusterDT5.9-60W E14 927 P45 CL G	5,9 W	60 W

Meccanica e corpo

Order Code	Full Product Name	Forma lampadina
44941100	MAS LEDCandleDT3.4-40W E14 927 B35CL G	B35
44957200	MAS LEDCandleDT5.9-60W E14 927 B35 CL G	B35
44935000	MAS LEDCandleDT2.5-25W E14 B35 CL G	B35
44949700	MAS LEDCandleDT3.4-40W E14927 BA35CL G	BA35
44953400	MAS LEDLusterDT3.5-40W E27 927 P45CL G	P45

Order Code	Full Product Name	Forma lampadina
44939800	MAS LEDLusterDT2.5-25W E27 927 P45CL G	P45
44937400	MAS LEDLusterDT2.5-25W E14 927 P45CL G	P45
44951000	MAS LEDLusterDT3.4-40W E14 927 P45CL G	P45
44961900	MAS LEDLusterDT5.9-60W E14 927 P45 CL G	P45

Approvazione e applicazione

Order Code	Full Product Name	Consumo energetico kWh/1000 h
44941100	MAS LEDCandleDT3.4-40W E14 927 B35CL G	4 kWh
44957200	MAS LEDCandleDT5.9-60W E14 927 B35 CL G	6 kWh
44935000	MAS LEDCandleDT2.5-25W E14 B35 CL G	3 kWh
44949700	MAS LEDCandleDT3.4-40W E14927 BA35CL G	4 kWh
44953400	MAS LEDLusterDT3.5-40W E27 927 P45CL G	4 kWh
44939800	MAS LEDLusterDT2.5-25W E27 927 P45CL G	3 kWh
44937400	MAS LEDLusterDT2.5-25W E14 927 P45CL G	3 kWh
44951000	MAS LEDLusterDT3.4-40W E14 927 P45CL G	4 kWh
44961900	MAS LEDLusterDT5.9-60W E14 927 P45 CL G	6 kWh

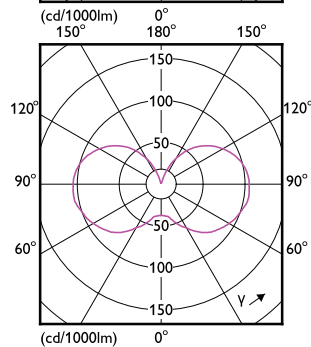
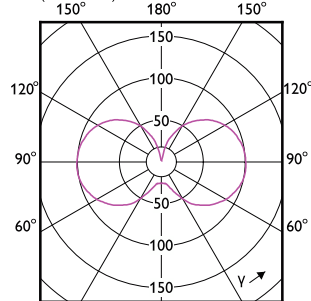
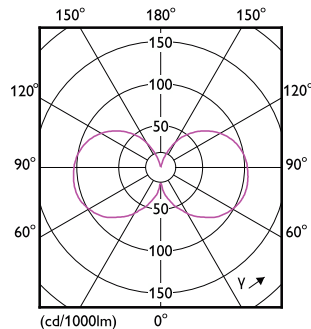
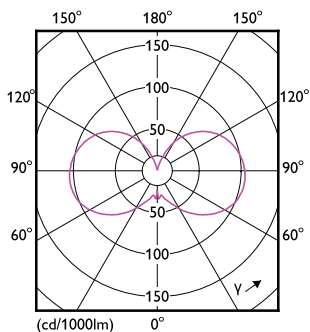

Lampadine a oliva e sferiche LED MASTER in vetro

