



For an optimal combination of value and performance

MASTER Value Glass LED bulbs

Featuring a classic heritage design, these filament LED bulbs combine the familiar shapes of incandescent bulbs with the benefits of long-lasting LED technology. These MASTER Value Glass LED bulbs offer more energy savings than normal glass LED bulbs. At the same time, they also provide customers with good light experience, enhanced by excellent dimming performance (dimmable glass LED bulbs). MASTER Value Glass LED Bulbs deliver significant energy savings, using 30% less energy compared to normal LED bulbs and provide excellent quality of light. By offering a lifetime of 15,000 hours, these dimmable LED bulbs also reduce maintenance costs.

Benefits

- Saves 30% energy compared with standard Philips LED bulbs
- Very long lifetime that reduces the need for replacements
- Easy retrofit replacement for conventional lamps

Features

- heritage design with classic shapes
- perfect fit and high-quality finish
- Very good light quality with excellent colour rendering (CRI>90)
- Designed to be seen, they look good switched on or off
- Environmentally friendly: contains no mercury or other hazardous substances

Application

- Home
- Hospitality

MASTER Value Glass LED bulbs

Versions



LEDbulb MAS G120 E27 CL



LEDclassic A60 B22 FR POS2



LEDclassic 60W G93 E27 CL
WGD90 1PF 4 1



LEDclassic 60W ST64 E27 CL
WGD90 SRT4 1

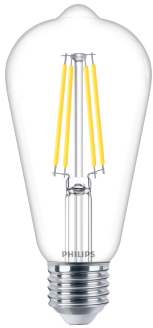

LEDbulb MAS ST64 E27 CL

Dimensional drawing

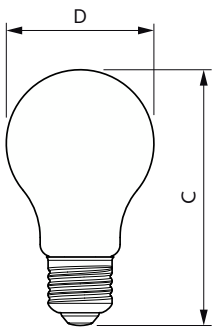

Product	D	C
MAS VLE LEDBulb D7.8-75W E27 927 A60 FRG	60 mm	104 mm
MAS VLE LEDBulbD11.2-100W E27 927 A60FRG	60 mm	108 mm
MAS VLE LEDBulbD3.4-40W E27 927 A60 FR G	60 mm	104 mm
MASVLELEDBulb D5.9-60W E27 927A60FR G UK	60 mm	104 mm

MASTER Value Glass LED bulbs

Dimensional drawing

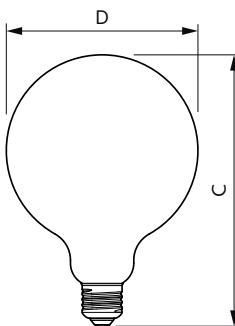
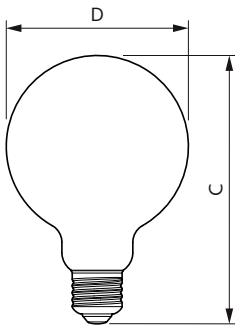
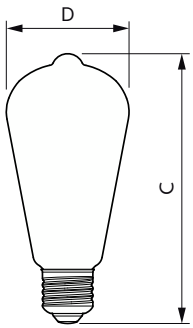
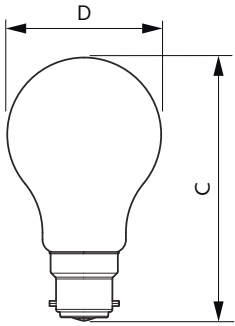

Product	D	C
MASVLE LEDBulbD10.5-100W B22A60 927FRGUK	60 mm	107 mm
MASVLE LEDBulbD5.9-60W B22A60 927FR G UK	60 mm	103 mm

Product	D	C
MAS VLE LEDBulb D5.9-60W E27 927 ST64CLG	64 mm	140 mm
MAS VLE LEDBulb DT5.9-60W E27 927ST64CLG	64 mm	140 mm

Product	D	C
MAS VLE LEDBulb DT5.9-60W E27 927G93CL G	95 mm	137 mm

Product	D	C
MAS VLE LEDBulb D5.9-60W E27 927 G120CLG	124 mm	178 mm

MASTER Value Glass LED bulbs

General Information	
Switching Cycle	20,000
Nominal lifetime	15,000 h
Light Technical	
Beam angle (nom.)	300 degree(s)
Colour rendering index (CRI)	90
LLMF at end of nominal lifetime (nom.)	70 %
Operating and Electrical	
Input frequency	50 to 60 Hz
Line Frequency	50 to 60 Hz
Starting time (nom.)	0.5 s
Controls and Dimming	
Dimmable	Only with specific dimmers
Approval and Application	
Ambient temperature range	-20 to +45 °C

General Information

Order Code	Full Product Name	Cap base
929003057799	MASVLELED Bulb D5.9-60W E27 927A60FR G UK	E27
929003058102	MAS VLE LED Bulb D7.8-75W E27 927 A60 FRG	E27
929003058502	MAS VLE LED Bulb D11.2-100W E27 927 A60FRG	E27
929003070702	MAS VLE LED Bulb D3.4-40W E27 927 A60 FR G	E27
929003059302	MAS VLE LED Bulb D5.9-60W E27 927 G120CLG	E27
929003010699	MASVLE LED Bulb D5.9-60W B22A60 927FR G UK	B22
929003011899	MASVLE LED Bulb D10.5-100W B22A60 927FRGUK	B22
929003010902	MAS VLE LED Bulb DT5.9-60W E27 927G93CL G	E27
929003010702	MAS VLE LED Bulb DT5.9-60W E27 927ST64CLG	E27
929003059402	MAS VLE LED Bulb D5.9-60W E27 927 ST64CLG	E27

Light Technical

Order Code	Full Product Name	Correlated Colour		
		Temperature (Nom)	Colour Code	Luminous Flux
929003057799	MASVLELED Bulb D5.9-60W E27 927A60FR G UK	2700 K	927	806 lm
929003058102	MAS VLE LED Bulb D7.8-75W E27 927 A60 FRG	2700 K	927	1,055 lm
929003058502	MAS VLE LED Bulb D11.2-100W E27 927 A60FRG	2700 K	927	1,521 lm
929003070702	MAS VLE LED Bulb D3.4-40W E27 927 A60 FR G	2700 K	927	470 lm
929003059302	MAS VLE LED Bulb D5.9-60W E27 927 G120CLG	2700 K	927	806 lm
929003010699	MASVLE LED Bulb D5.9-60W B22A60 927FR G UK	2700 K	927	806 lm

Order Code	Full Product Name	Correlated Colour		
		Temperature (Nom)	Colour Code	Luminous Flux
929003011899	MASVLE LED Bulb D10.5-100W B22A60 927FRGUK	2700 K	927	1,521 lm
929003010902	MAS VLE LED Bulb DT5.9-60W E27 927G93CL G	2200 K	922-927	806 lm
929003010702	MAS VLE LED Bulb DT5.9-60W E27 927ST64CLG	2200 K	922-927	806 lm
929003059402	MAS VLE LED Bulb D5.9-60W E27 927 ST64CLG	2700 K	927	806 lm

Operating and Electrical

Order Code	Full Product Name	Power	Wattage
		Consumption	equivalent
929003057799	MASVLELED Bulb D5.9-60W E27 927A60FR G UK	5.9 W	60 W
929003058102	MAS VLE LED Bulb D7.8-75W E27 927 A60 FRG	7.8 W	75 W
929003058502	MAS VLE LED Bulb D11.2-100W E27 927 A60FRG	11.2 W	100 W

Order Code	Full Product Name	Power	Wattage
		Consumption	equivalent
929003070702	MAS VLE LED Bulb D3.4-40W E27 927 A60 FR G	3.4 W	40 W
929003059302	MAS VLE LED Bulb D5.9-60W E27 927 G120CLG	5.9 W	60 W
929003010699	MASVLE LED Bulb D5.9-60W B22A60 927FR G UK	5.9 W	60 W

MASTER Value Glass LED bulbs

Order Code	Full Product Name	Power Consumption	Wattage equivalent
929003011899	MASVLE LEDBulbD10.5-100W B22A60 927FRGUK	10.5 W	100 W
929003010902	MAS VLE LEDBulb DT5.9-60W E27 927G93CL G	5.9 W	60 W

Order Code	Full Product Name	Power Consumption	Wattage equivalent
929003010702	MAS VLE LEDBulb DT5.9-60W E27 927ST64CLG	5.9 W	60 W
929003059402	MAS VLE LEDBulb D5.9-60W E27 927 ST64CLG	5.9 W	60 W

Temperature

Order Code	Full Product Name	T-Case maximum (nom.)
929003057799	MASVLELEDBulb D5.9-60W E27 927A60FR G UK	80 °C
929003058102	MAS VLE LEDBulb D7.8-75W E27 927 A60 FRG	80 °C
929003058502	MAS VLE LEDBulbD11.2-100W E27 927 A60FRG	80 °C
929003070702	MAS VLE LEDBulbD3.4-40W E27 927 A60 FR G	80 °C
929003059302	MAS VLE LEDBulb D5.9-60W E27 927 G120CLG	80 °C
929003010699	MASVLE LEDBulbD5.9-60W B22A60 927FR G UK	70 °C

Order Code	Full Product Name	T-Case maximum (nom.)
929003011899	MASVLE LEDBulbD10.5-100W B22A60 927FRGUK	70 °C
929003010902	MAS VLE LEDBulb DT5.9-60W E27 927G93CL G	70 °C
929003010702	MAS VLE LEDBulb DT5.9-60W E27 927ST64CLG	70 °C
929003059402	MAS VLE LEDBulb D5.9-60W E27 927 ST64CLG	80 °C

Mechanical and Housing

Order Code	Full Product Name	Lamp Finish	Bulb shape
929003057799	MASVLELEDBulb D5.9-60W E27 927A60FR G UK	Frosted	A60
929003058102	MAS VLE LEDBulb D7.8-75W E27 927 A60 FRG	Frosted	A60
929003058502	MAS VLE LEDBulbD11.2-100W E27 927 A60FRG	Frosted	A60
929003070702	MAS VLE LEDBulbD3.4-40W E27 927 A60 FR G	Frosted	A60
929003059302	MAS VLE LEDBulb D5.9-60W E27 927 G120CLG	Clear	G120

Order Code	Full Product Name	Lamp Finish	Bulb shape
929003010699	MASVLE LEDBulbD5.9-60W B22A60 927FR G UK	Frosted	A60
929003011899	MASVLE LEDBulbD10.5-100W B22A60 927FRGUK	Frosted	A60
929003010902	MAS VLE LEDBulb DT5.9-60W E27 927G93CL G	Clear	G93
929003010702	MAS VLE LEDBulb DT5.9-60W E27 927ST64CLG	Clear	ST64
929003059402	MAS VLE LEDBulb D5.9-60W E27 927 ST64CLG	Clear	ST64

Approval and Application

Order Code	Full Product Name	Energy consumption kWh/1,000 hours
929003057799	MASVLELEDBulb D5.9-60W E27 927A60FR G UK	6 kWh
929003058102	MAS VLE LEDBulb D7.8-75W E27 927 A60 FRG	8 kWh
929003058502	MAS VLE LEDBulbD11.2-100W E27 927 A60FRG	12 kWh
929003070702	MAS VLE LEDBulbD3.4-40W E27 927 A60 FR G	4 kWh
929003059302	MAS VLE LEDBulb D5.9-60W E27 927 G120CLG	6 kWh
929003010699	MASVLE LEDBulbD5.9-60W B22A60 927FR G UK	6 kWh
929003011899	MASVLE LEDBulbD10.5-100W B22A60 927FRGUK	11 kWh
929003010902	MAS VLE LEDBulb DT5.9-60W E27 927G93CL G	6 kWh

Order Code	Full Product Name	Energy consumption kWh/1,000 hours
929003010702	MAS VLE LEDBulb DT5.9-60W E27 927ST64CLG	6 kWh
929003059402	MAS VLE LEDBulb D5.9-60W E27 927 ST64CLG	6 kWh

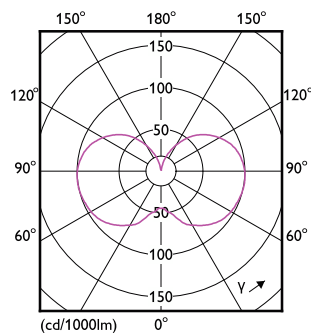

MASTER Value Glass LED bulbs

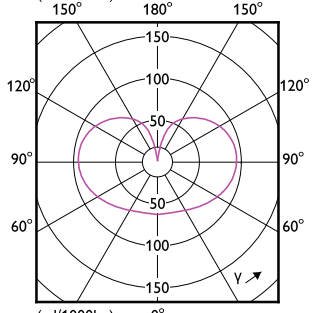
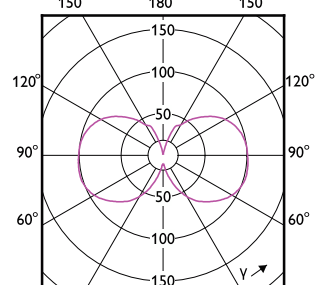
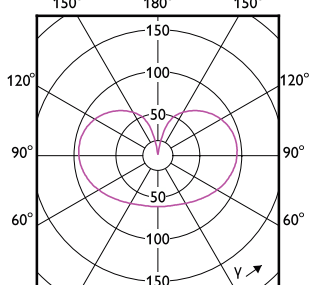
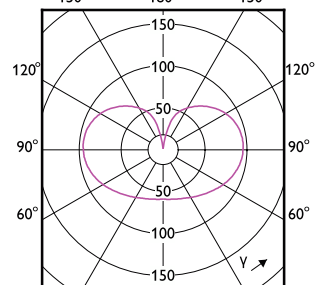
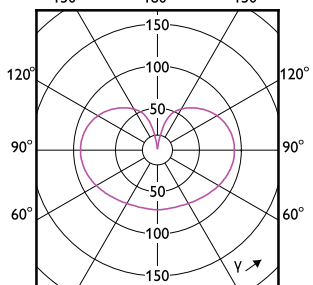
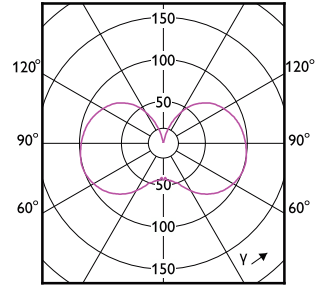
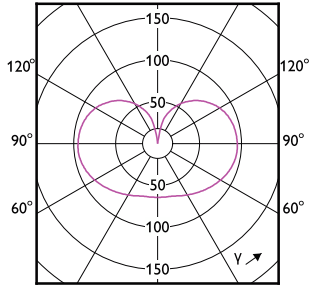
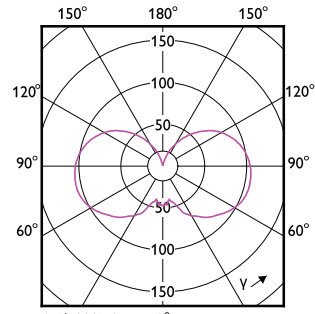
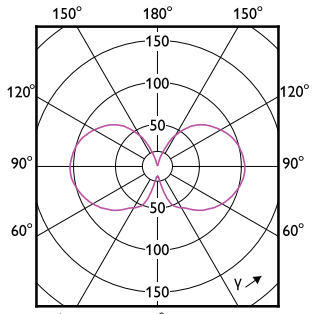

MASTER Value Glass LED bulbs

