



Bring out the beauty in merchandise with brighter, high performance lighting

MASTER LED spot PAR High Lumen

Philips High Lumen PAR30L integrates a leading COB LED light source and a compact high efficiency driver into a traditional CDM PAR30L form-factor. It brings out the beauty in merchandise with brighter, high performance lighting. Additionally, the lamp features an over temperature protection (OTP) to ensure a long operating life time.

Benefits

- Lower initial investment for LED CDM replacement PAR30
- Up to 43% energy saving compared to standard CDM lamps
- High efficiency solution >100lm/W

Features

- Easy retrofit to CDM PAR30L lamps with E27 base
- Emits virtually no heat and will not fade colors
- Lifetime of 25,000 hours
- UV- and IR-free light
- Free of mercury and hazardous materials – RoHS Compliant

Application

- Shops, hotels, restaurants, museums

MASTER LED spot PAR High Lumen

Dimensional drawing

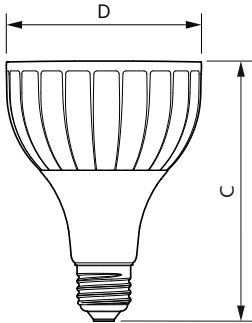

Product	D	C
Master LED PAR30L 20W 15D 830	95.5 mm	129 mm
Master LED PAR30L 20W 30D 830	95.5 mm	129 mm
Master LED PAR30L 20W 30D 840	95.5 mm	129 mm
Master LED PAR30L 32W 30D 830	95.5 mm	129 mm
Master LED PAR30L 32W 30D 840	95.5 mm	129 mm
Master LED PAR30L 32W 30D 857	95.5 mm	129 mm

General Information

Cap-Base	E27
Switching Cycle	50,000
Nominal lifetime	25,000 hour(s)

Light Technical

Color rendering index (CRI)	82
LLMF At End Of Nominal Lifetime (Nom)	70 %

Operating and Electrical

Input Frequency	50 to 60 Hz
Line Frequency	50 to 60 Hz
Starting Time (Nom)	0.5 s

Controls and Dimming

Dimmable	No
----------	----

Mechanical and Housing

Bulb Shape	PAR30L
------------	--------

Approval and Application

Ambient temperature range	-20 °C to 45 °C
---------------------------	-----------------

Light Technical (1/2)

Order Code	Full Product Name	Beam Angle (Nom)	Correlated Color Temperature (Nom)	Color Code	Luminous Flux
929001353808	Master LED PAR30L 20W 15D 830	15 degree(s)	3000 K	830	1,800 lm
929001354008	Master LED PAR30L 20W 30D 830	30 degree(s)	3000 K	830	1,800 lm
929001354108	Master LED PAR30L 20W 30D 840	30 degree(s)	4000 K	840	1,850 lm
929001354708	Master LED PAR30L 32W 30D 830	30 degree(s)	3000 K	830	3,000 lm
929001354808	Master LED PAR30L 32W 30D 840	30 degree(s)	4000 K	840	3,000 lm
929001354908	Master LED PAR30L 32W 30D 857	30 degree(s)	5700 K	857	3,000 lm

Light Technical (2/2)

Order Code	Full Product Name	Luminous Intensity (Nom)	Order Code	Full Product Name	Luminous Intensity (Nom)
929001353808	Master LED PAR30L 20W 15D 830	18,000 cd	929001354708	Master LED PAR30L 32W 30D 830	-
929001354008	Master LED PAR30L 20W 30D 830	5,400 cd	929001354808	Master LED PAR30L 32W 30D 840	-
929001354108	Master LED PAR30L 20W 30D 840	-	929001354908	Master LED PAR30L 32W 30D 857	-

Operating and Electrical

Order Code	Full Product Name	Power Consumption	Wattage Equivalent	Order Code	Full Product Name	Power Consumption	Wattage Equivalent
929001353808	Master LED PAR30L 20W 15D 830	20 W	35 W	929001354008	Master LED PAR30L 20W 30D 830	20 W	35 W

MASTER LED spot PAR High Lumen

Order Code	Full Product Name	Power Consumption	Wattage Equivalent
929001354108	Master LED PAR30L 20W 30D 840	20 W	35 W
929001354708	Master LED PAR30L 32W 30D 830	32 W	50 W

Order Code	Full Product Name	Power Consumption	Wattage Equivalent
929001354808	Master LED PAR30L 32W 30D 840	32 W	50 W
929001354908	Master LED PAR30L 32W 30D 857	32 W	50 W

Temperature

Order Code	Full Product Name	T-Case Maximum (Nom)
929001353808	Master LED PAR30L 20W 15D 830	67 °C
929001354008	Master LED PAR30L 20W 30D 830	67 °C
929001354108	Master LED PAR30L 20W 30D 840	67 °C

Order Code	Full Product Name	T-Case Maximum (Nom)
929001354708	Master LED PAR30L 32W 30D 830	79 °C
929001354808	Master LED PAR30L 32W 30D 840	79 °C
929001354908	Master LED PAR30L 32W 30D 857	79 °C

Approval and Application

Order Code	Full Product Name	Energy Consumption kWh/1000 h
929001353808	Master LED PAR30L 20W 15D 830	20 kWh
929001354008	Master LED PAR30L 20W 30D 830	20 kWh
929001354108	Master LED PAR30L 20W 30D 840	20 kWh
929001354708	Master LED PAR30L 32W 30D 830	32 kWh
929001354808	Master LED PAR30L 32W 30D 840	32 kWh
929001354908	Master LED PAR30L 32W 30D 857	32 kWh

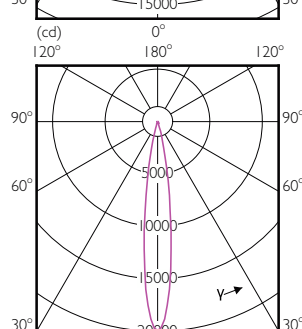
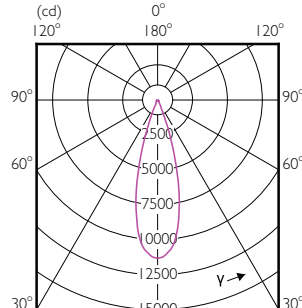
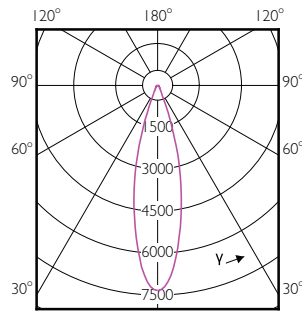
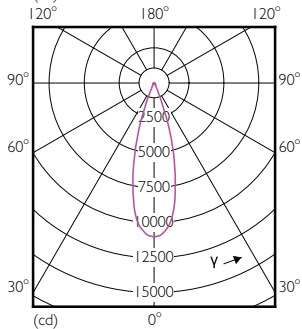
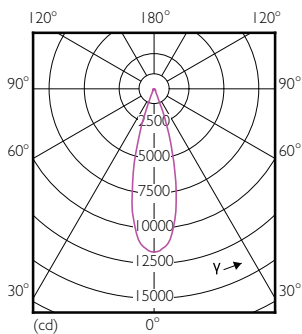

MASTER LED spot PAR High Lumen

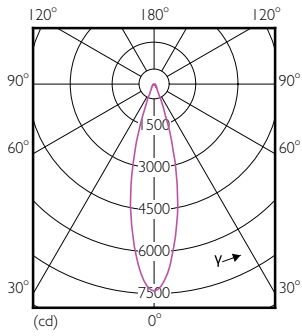

Accent Diagrams

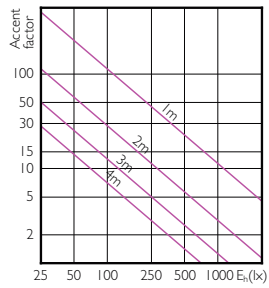

Accent Diagram - Master LED PAR30L 32W 30D 840

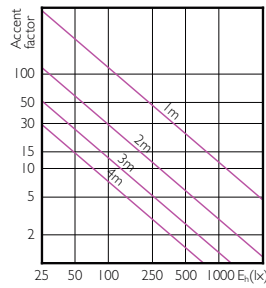

Accent Diagram - Master LED PAR30L 32W 30D 830

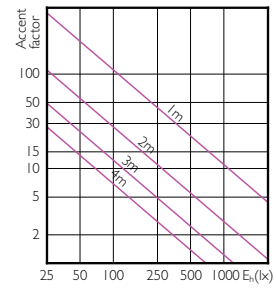

Accent Diagram - Master LED PAR30L 32W 30D 857

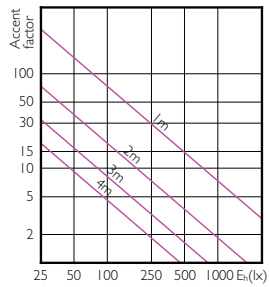

Accent Diagram - Master LED PAR30L 20W 30D 840

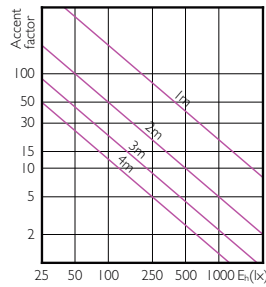

Accent Diagram - Master LED PAR30L 20W 15D 830

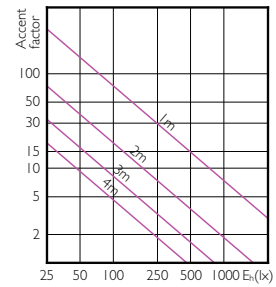

Accent Diagram - Master LED PAR30L 20W 30D 830

MASTER LED spot PAR High Lumen

Beam Diagrams

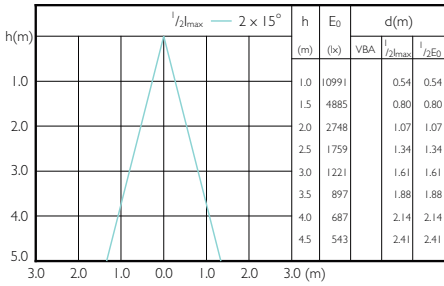

Beam diagram - Master LED PAR30L 32W 30D 857

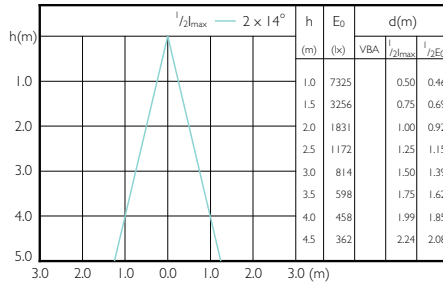

Beam diagram - Master LED PAR30L 20W 30D 840

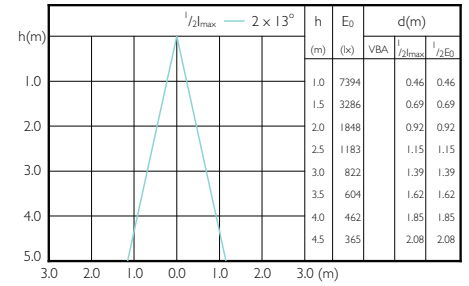

Beam diagram - Master LED PAR30L 20W 30D 830

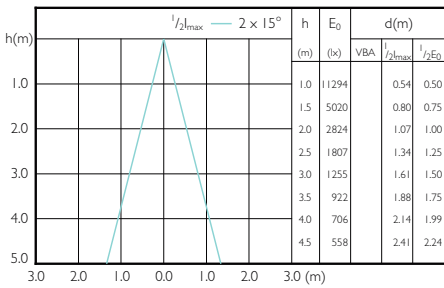

Beam diagram - Master LED PAR30L 32W 30D 840

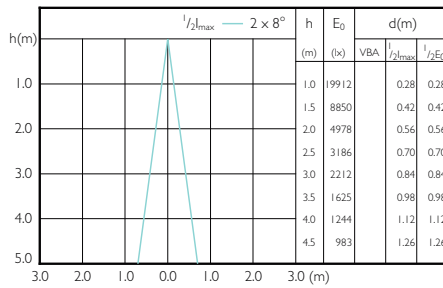

Beam diagram - Master LED PAR30L 20W 15D 830

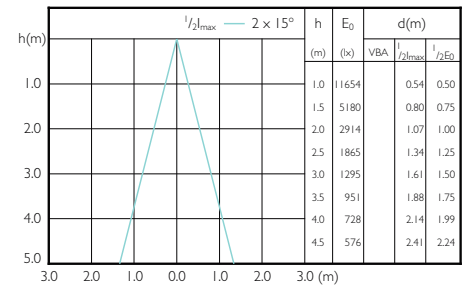

Beam diagram - Master LED PAR30L 32W 30D 830

