



Bring out the beauty in merchandise with brighter, high performance lighting

MASTER LED spot PAR High Lumen

Philips High Lumen PAR30L integrates a leading COB LED light source and a compact high efficiency driver into a traditional CDM PAR30L form-factor. It brings out the beauty in merchandise with brighter, high performance lighting. Additionally, the lamp features an over temperature protection (OTP) to ensure a long operating life time.

Benefits

- Lower initial investment for LED CDM replacement PAR30
- Up to 43% energy saving compared to standard CDM lamps
- High efficiency solution >100lm/W

Features

- Easy retrofit to CDM PAR30L lamps with E27 base
- Emits virtually no heat and will not fade colors
- Lifetime of 25,000 hours
- UV- and IR-free light
- Free of mercury and hazardous materials – RoHS Compliant

Application

- Shops, hotels, restaurants, museums

MASTER LED spot PAR High Lumen

Dimensional drawing

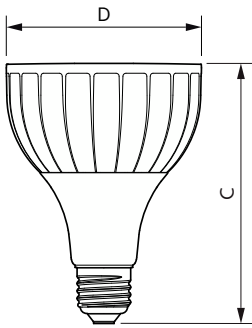
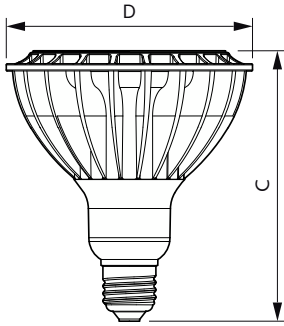

Product	D	C
33PAR38/PER/835/F25/DIM/120V 6/1FB	123 mm	133 mm
33PAR38/PER/835/S15/DIM/120V 6/1FB	123 mm	133 mm

Product	D	C
Master LED PAR30L 20W 15D 830	95.5 mm	129 mm
Master LED PAR30L 20W 15D 830 CN	95.5 mm	129 mm
Master LED PAR30L 20W 15D 840 CN	95.5 mm	129 mm
Master LED PAR30L 20W 30D 830	95.5 mm	129 mm
Master LED PAR30L 20W 30D 830 CN	95.5 mm	129 mm
Master LED PAR30L 20W 30D 840	95.5 mm	129 mm
Master LED PAR30L 20W 30D 840 CN	95.5 mm	129 mm
Master LED PAR30L 28W 15D 830 100-277V	95.5 mm	129 mm
Master LED PAR30L 28W 30D 830 100-277V	95.5 mm	129 mm
Master LED PAR30L 32W 15D 830 CN	95.5 mm	129 mm
Master LED PAR30L 32W 15D 840 CN	95.5 mm	129 mm
Master LED PAR30L 32W 15D 860 CN	95.5 mm	129 mm
Master LED PAR30L 32W 30D 830	95.5 mm	129 mm
Master LED PAR30L 32W 30D 830 220V		
Master LED PAR30L 32W 30D 830 CN	95.5 mm	129 mm
Master LED PAR30L 32W 30D 840	95.5 mm	129 mm
Master LED PAR30L 32W 30D 840 220V		
Master LED PAR30L 32W 30D 840 CN	95.5 mm	129 mm
Master LED PAR30L 32W 30D 857	95.5 mm	129 mm
Master LED PAR30L 32W 30D 860 CN	95.5 mm	129 mm
Master LED PAR30L 40W 30D 830 CN	95.5 mm	129 mm
Master LED PAR30L 40W 30D 840 CN	95.5 mm	129 mm

General Information

Switching Cycle	50,000
Nominal lifetime	25,000 hour(s)

Light Technical

LLMF At End Of Nominal Lifetime (Nom)	70 %
---------------------------------------	------

Operating and Electrical

Input Frequency	50 to 60 Hz
Starting Time (Nom)	0.5 s

General Information

MASTER LED spot PAR High Lumen

Order Code	Full Product Name	Cap-Base	Order Code	Full Product Name	Cap-Base
929004431104	33PAR38/PER/835/S15/DIM/120V 6/1FB	E26	929001354708	Master LED PAR30L 32W 30D 830	E27
929004431204	33PAR38/PER/835/F25/DIM/120V 6/1FB	E26	929001354710	Master LED PAR30L 32W 30D 830 CN	E27
929001353808	Master LED PAR30L 20W 15D 830	E27	929001354722	Master LED PAR30L 32W 30D 830 220V	E27
929001353810	Master LED PAR30L 20W 15D 830 CN	E27	929001354808	Master LED PAR30L 32W 30D 840	E27
929001353910	Master LED PAR30L 20W 15D 840 CN	E27	929001354810	Master LED PAR30L 32W 30D 840 CN	E27
929001354008	Master LED PAR30L 20W 30D 830	E27	929001354822	Master LED PAR30L 32W 30D 840 220V	E27
929001354010	Master LED PAR30L 20W 30D 830 CN	E27	929001354908	Master LED PAR30L 32W 30D 857	E27
929001354108	Master LED PAR30L 20W 30D 840	E27	929001354910	Master LED PAR30L 32W 30D 860 CN	E27
929001354110	Master LED PAR30L 20W 30D 840 CN	E27	929001374810	Master LED PAR30L 40W 30D 830 CN	E27
929001354310	Master LED PAR30L 32W 15D 830 CN	E27	929001374910	Master LED PAR30L 40W 30D 840 CN	E27
929001354410	Master LED PAR30L 32W 15D 840 CN	E27	929001941912	Master LED PAR30L 28W 15D 830 100-277V	E27
929001354510	Master LED PAR30L 32W 15D 860 CN	E27	929001942012	Master LED PAR30L 28W 30D 830 100-277V	E27

Light Technical

Order Code	Full Product Name	Beam Angle (Nom)	Correlated Color		Color rendering		Luminous Intensity	
			Temperature (Nom)	index (CRI)	Color Code	Luminous Flux (Nom)		
929004431104	33PAR38/PER/835/S15/DIM/120V 6/1FB	15 degree(s)	3500 K	80	835	3,000 lm	33,000 cd	
929004431204	33PAR38/PER/835/F25/DIM/120V 6/1FB	25 degree(s)	3500 K	80	835	3,000 lm	10,000 cd	
929001353808	Master LED PAR30L 20W 15D 830	15 degree(s)	3000 K	82	830	1,800 lm	18,000 cd	
929001353810	Master LED PAR30L 20W 15D 830 CN	15 degree(s)	3000 K	82	830	1,800 lm	18,000 cd	
929001353910	Master LED PAR30L 20W 15D 840 CN	15 degree(s)	4000 K	82	840	1,850 lm	-	
929001354008	Master LED PAR30L 20W 30D 830	30 degree(s)	3000 K	82	830	1,800 lm	5,400 cd	
929001354010	Master LED PAR30L 20W 30D 830 CN	30 degree(s)	3000 K	82	830	1,800 lm	5,400 cd	
929001354108	Master LED PAR30L 20W 30D 840	30 degree(s)	4000 K	82	840	1,850 lm	-	
929001354110	Master LED PAR30L 20W 30D 840 CN	30 degree(s)	4000 K	82	840	1,850 lm	-	
929001354310	Master LED PAR30L 32W 15D 830 CN	15 degree(s)	3000 K	82	830	3,000 lm	-	
929001354410	Master LED PAR30L 32W 15D 840 CN	15 degree(s)	4000 K	82	840	3,000 lm	-	
929001354510	Master LED PAR30L 32W 15D 860 CN	15 degree(s)	6000 K	82	860	3,000 lm	-	
929001354708	Master LED PAR30L 32W 30D 830	30 degree(s)	3000 K	82	830	3,000 lm	-	
929001354710	Master LED PAR30L 32W 30D 830 CN	30 degree(s)	3000 K	82	830	3,000 lm	-	
929001354722	Master LED PAR30L 32W 30D 830 220V	30 degree(s)	3000 K	80	830	3,000 lm	11,000 cd	
929001354808	Master LED PAR30L 32W 30D 840	30 degree(s)	4000 K	82	840	3,000 lm	-	
929001354810	Master LED PAR30L 32W 30D 840 CN	30 degree(s)	4000 K	82	840	3,000 lm	-	
929001354822	Master LED PAR30L 32W 30D 840 220V	30 degree(s)	4000 K	80	840	3,000 lm	12,000 cd	
929001354908	Master LED PAR30L 32W 30D 857	30 degree(s)	5700 K	82	857	3,000 lm	-	
929001354910	Master LED PAR30L 32W 30D 860 CN	30 degree(s)	6000 K	82	860	3,000 lm	-	
929001374810	Master LED PAR30L 40W 30D 830 CN	30 degree(s)	3000 K	82	830	4,500 lm	13,500 cd	
929001374910	Master LED PAR30L 40W 30D 840 CN	30 degree(s)	4000 K	82	840	4,600 lm	14,000 cd	
929001941912	Master LED PAR30L 28W 15D 830 100-277V	15 degree(s)	3000 K	80	830	3,000 lm	27,000 cd	
929001942012	Master LED PAR30L 28W 30D 830 100-277V	30 degree(s)	3000 K	80	830	3,000 lm	9,600 cd	

Operating and Electrical

Order Code	Full Product Name	Line Frequency	Power		Order Code	Full Product Name	Line Frequency	Power	
			Consumption	Wattage Equivalent				Consumption	Wattage Equivalent
929004431104	33PAR38/PER/835/S15/DIM/120V 6/1FB	-	33 W	250 W	929001353808	Master LED PAR30L 20W 15D 830	50 to 60 Hz	20 W	35 W
929004431204	33PAR38/PER/835/F25/DIM/120V 6/1FB	-	33 W	250 W	929001353810	Master LED PAR30L 20W 15D 830 CN	50 to 60 Hz	20 W	35 W

MASTER LED spot PAR High Lumen

Order Code	Full Product Name	Line Frequency	Power	Wattage
			Consumption	Equivalent
929001353910	Master LED PAR30L 20W 15D 840 CN	50 to 60 Hz	20 W	35 W
929001354008	Master LED PAR30L 20W 30D 830	50 to 60 Hz	20 W	35 W
929001354010	Master LED PAR30L 20W 30D 830 CN	50 to 60 Hz	20 W	35 W
929001354108	Master LED PAR30L 20W 30D 840	50 to 60 Hz	20 W	35 W
929001354110	Master LED PAR30L 20W 30D 840 CN	50 to 60 Hz	20 W	35 W
929001354310	Master LED PAR30L 32W 15D 830 CN	50 to 60 Hz	32 W	50 W
929001354410	Master LED PAR30L 32W 15D 840 CN	50 to 60 Hz	32 W	50 W
929001354510	Master LED PAR30L 32W 15D 860 CN	50 to 60 Hz	32 W	50 W
929001354708	Master LED PAR30L 32W 30D 830	50 to 60 Hz	32 W	50 W
929001354710	Master LED PAR30L 32W 30D 830 CN	50 to 60 Hz	32 W	50 W
929001354722	Master LED PAR30L 32W 30D 830 220V	-	32 W	50 W

Order Code	Full Product Name	Line Frequency	Power	Wattage
			Consumption	Equivalent
929001354808	Master LED PAR30L 32W 30D 840	50 to 60 Hz	32 W	50 W
929001354810	Master LED PAR30L 32W 30D 840 CN	50 to 60 Hz	32 W	50 W
929001354822	Master LED PAR30L 32W 30D 840 220V	-	32 W	50 W
929001354908	Master LED PAR30L 32W 30D 857	50 to 60 Hz	32 W	50 W
929001354910	Master LED PAR30L 32W 30D 860 CN	50 to 60 Hz	32 W	50 W
929001374810	Master LED PAR30L 40W 30D 830 CN	50 to 60 Hz	40 W	70 W
929001374910	Master LED PAR30L 40W 30D 840 CN	50 to 60 Hz	40 W	70 W
929001941912	Master LED PAR30L 28W 15D 830 100-277V	50 to 60 Hz	28 W	50 W
929001942012	Master LED PAR30L 28W 30D 830 100-277V	50 to 60 Hz	28 W	50 W

Temperature

Order Code	Full Product Name	T-Case Maximum (Nom)
929004431104	33PAR38/PER/835/S15/DIM/120V 6/1FB	90 °C
929004431204	33PAR38/PER/835/F25/DIM/120V 6/1FB	90 °C
929001353808	Master LED PAR30L 20W 15D 830	67 °C
929001353810	Master LED PAR30L 20W 15D 830 CN	67 °C
929001353910	Master LED PAR30L 20W 15D 840 CN	67 °C
929001354008	Master LED PAR30L 20W 30D 830	67 °C
929001354010	Master LED PAR30L 20W 30D 830 CN	67 °C
929001354108	Master LED PAR30L 20W 30D 840	67 °C
929001354110	Master LED PAR30L 20W 30D 840 CN	67 °C
929001354310	Master LED PAR30L 32W 15D 830 CN	79 °C
929001354410	Master LED PAR30L 32W 15D 840 CN	79 °C
929001354510	Master LED PAR30L 32W 15D 860 CN	79 °C

Order Code	Full Product Name	T-Case Maximum (Nom)
929001354708	Master LED PAR30L 32W 30D 830	79 °C
929001354710	Master LED PAR30L 32W 30D 830 CN	79 °C
929001354722	Master LED PAR30L 32W 30D 830 220V	80 °C
929001354808	Master LED PAR30L 32W 30D 840	79 °C
929001354810	Master LED PAR30L 32W 30D 840 CN	79 °C
929001354822	Master LED PAR30L 32W 30D 840 220V	80 °C
929001354908	Master LED PAR30L 32W 30D 857	79 °C
929001354910	Master LED PAR30L 32W 30D 860 CN	79 °C
929001374810	Master LED PAR30L 40W 30D 830 CN	90 °C
929001374910	Master LED PAR30L 40W 30D 840 CN	90 °C
929001941912	Master LED PAR30L 28W 15D 830 100-277V	80 °C
929001942012	Master LED PAR30L 28W 30D 830 100-277V	80 °C

Controls and Dimming

Order Code	Full Product Name	Dimmable
929004431104	33PAR38/PER/835/S15/DIM/120V 6/1FB	Only with specific dimmers
929004431204	33PAR38/PER/835/F25/DIM/120V 6/1FB	Only with specific dimmers
929001353808	Master LED PAR30L 20W 15D 830	No
929001353810	Master LED PAR30L 20W 15D 830 CN	No
929001353910	Master LED PAR30L 20W 15D 840 CN	No
929001354008	Master LED PAR30L 20W 30D 830	No

Order Code	Full Product Name	Dimmable
929001354010	Master LED PAR30L 20W 30D 830 CN	No
929001354108	Master LED PAR30L 20W 30D 840	No
929001354110	Master LED PAR30L 20W 30D 840 CN	No
929001354310	Master LED PAR30L 32W 15D 830 CN	No
929001354410	Master LED PAR30L 32W 15D 840 CN	No
929001354510	Master LED PAR30L 32W 15D 860 CN	No
929001354708	Master LED PAR30L 32W 30D 830	No
929001354710	Master LED PAR30L 32W 30D 830 CN	No

MASTER LED spot PAR High Lumen

Order Code	Full Product Name	Dimmable
929001354722	Master LED PAR30L 32W 30D 830 220V	No
929001354808	Master LED PAR30L 32W 30D 840	No
929001354810	Master LED PAR30L 32W 30D 840 CN	No
929001354822	Master LED PAR30L 32W 30D 840 220V	No
929001354908	Master LED PAR30L 32W 30D 857	No

Order Code	Full Product Name	Dimmable
929001354910	Master LED PAR30L 32W 30D 860 CN	No
929001374810	Master LED PAR30L 40W 30D 830 CN	No
929001374910	Master LED PAR30L 40W 30D 840 CN	No
929001941912	Master LED PAR30L 28W 15D 830 100-277V	No
929001942012	Master LED PAR30L 28W 30D 830 100-277V	No

Mechanical and Housing

Order Code	Full Product Name	Bulb Finish	Bulb Shape
929004431104	33PAR38/PER/835/S15/DIM/120V 6/1FB	Clear	PAR38
929004431204	33PAR38/PER/835/F25/DIM/120V 6/1FB	Clear	PAR38
929001353808	Master LED PAR30L 20W 15D 830	-	PAR30L
929001353810	Master LED PAR30L 20W 15D 830 CN	-	PAR30L
929001353910	Master LED PAR30L 20W 15D 840 CN	-	PAR30L
929001354008	Master LED PAR30L 20W 30D 830	-	PAR30L
929001354010	Master LED PAR30L 20W 30D 830 CN	-	PAR30L
929001354108	Master LED PAR30L 20W 30D 840	-	PAR30L
929001354110	Master LED PAR30L 20W 30D 840 CN	-	PAR30L
929001354310	Master LED PAR30L 32W 15D 830 CN	-	PAR30L
929001354410	Master LED PAR30L 32W 15D 840 CN	-	PAR30L
929001354510	Master LED PAR30L 32W 15D 860 CN	-	PAR30L

Order Code	Full Product Name	Bulb Finish	Bulb Shape
929001354708	Master LED PAR30L 32W 30D 830	-	PAR30L
929001354710	Master LED PAR30L 32W 30D 830 CN	-	PAR30L
929001354722	Master LED PAR30L 32W 30D 830 220V	Clear	PAR30L
929001354808	Master LED PAR30L 32W 30D 840	-	PAR30L
929001354810	Master LED PAR30L 32W 30D 840 CN	-	PAR30L
929001354822	Master LED PAR30L 32W 30D 840 220V	Clear	PAR30L
929001354908	Master LED PAR30L 32W 30D 857	-	PAR30L
929001354910	Master LED PAR30L 32W 30D 860 CN	-	PAR30L
929001374810	Master LED PAR30L 40W 30D 830 CN	-	PAR30L
929001374910	Master LED PAR30L 40W 30D 840 CN	-	PAR30L
929001941912	Master LED PAR30L 28W 15D 830 100-277V	-	PAR30L
929001942012	Master LED PAR30L 28W 30D 830 100-277V	-	PAR30L

Approval and Application

Order Code	Full Product Name	Energy	
		Ambient temperature range	Consumption kWh/1000 h
929004431104	33PAR38/PER/835/S15/DIM/120V 6/1FB	-20 to +45 °C	-
929004431204	33PAR38/PER/835/F25/DIM/120V 6/1FB	-20 to +45 °C	-
929001353808	Master LED PAR30L 20W 15D 830	-20 °C to 45 °C	20 kWh
929001353810	Master LED PAR30L 20W 15D 830 CN	-20 °C to 45 °C	20 kWh
929001353910	Master LED PAR30L 20W 15D 840 CN	-20 °C to 45 °C	20 kWh
929001354008	Master LED PAR30L 20W 30D 830	-20 °C to 45 °C	20 kWh
929001354010	Master LED PAR30L 20W 30D 830 CN	-20 °C to 45 °C	20 kWh
929001354108	Master LED PAR30L 20W 30D 840	-20 °C to 45 °C	20 kWh
929001354110	Master LED PAR30L 20W 30D 840 CN	-20 °C to 45 °C	20 kWh
929001354310	Master LED PAR30L 32W 15D 830 CN	-20 °C to 45 °C	32 kWh
929001354410	Master LED PAR30L 32W 15D 840 CN	-20 °C to 45 °C	32 kWh
929001354510	Master LED PAR30L 32W 15D 860 CN	-20 °C to 45 °C	32 kWh

Order Code	Full Product Name	Energy	
		Ambient temperature range	Consumption kWh/1000 h
929001354708	Master LED PAR30L 32W 30D 830	-20 °C to 45 °C	32 kWh
929001354710	Master LED PAR30L 32W 30D 830 CN	-20 °C to 45 °C	32 kWh
929001354722	Master LED PAR30L 32W 30D 830 220V	-20 °C to 45 °C	-
929001354808	Master LED PAR30L 32W 30D 840	-20 °C to 45 °C	32 kWh
929001354810	Master LED PAR30L 32W 30D 840 CN	-20 °C to 45 °C	32 kWh
929001354822	Master LED PAR30L 32W 30D 840 220V	-20 °C to 45 °C	-
929001354908	Master LED PAR30L 32W 30D 857	-20 °C to 45 °C	32 kWh
929001354910	Master LED PAR30L 32W 30D 860 CN	-20 °C to 45 °C	32 kWh
929001374810	Master LED PAR30L 40W 30D 830 CN	-20 °C to 45 °C	40 kWh
929001374910	Master LED PAR30L 40W 30D 840 CN	-20 °C to 45 °C	40 kWh
929001941912	Master LED PAR30L 28W 15D 830 100-277V	-20 to +45 °C	-
929001942012	Master LED PAR30L 28W 30D 830 100-277V	-20 to +45 °C	-

MASTER LED spot PAR High Lumen

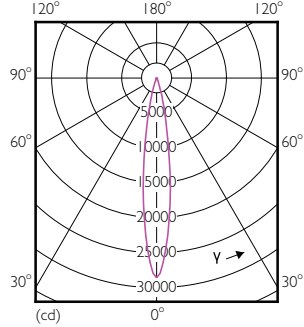
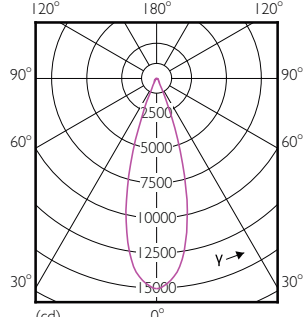
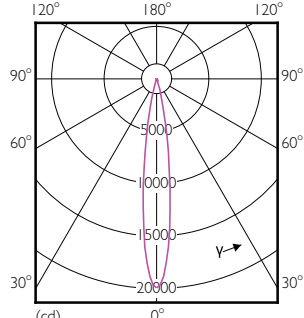
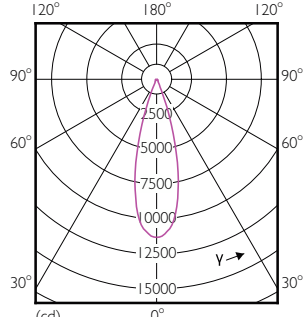
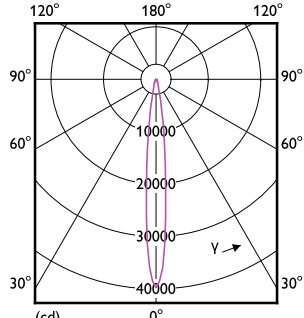
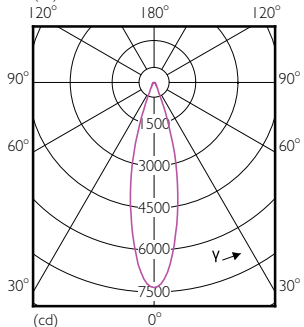
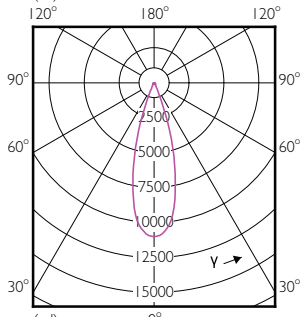
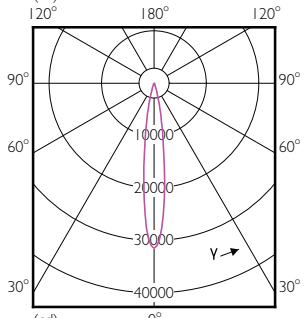
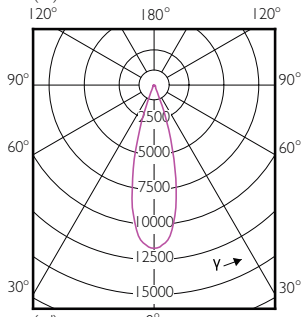
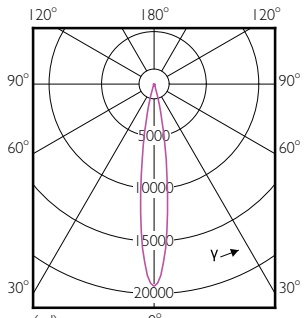

MASTER LED spot PAR High Lumen

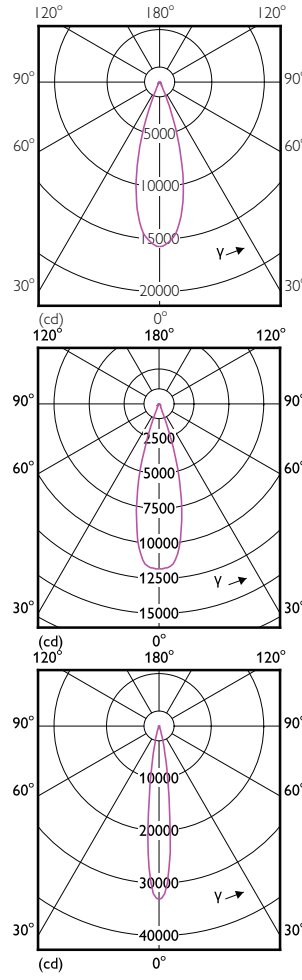
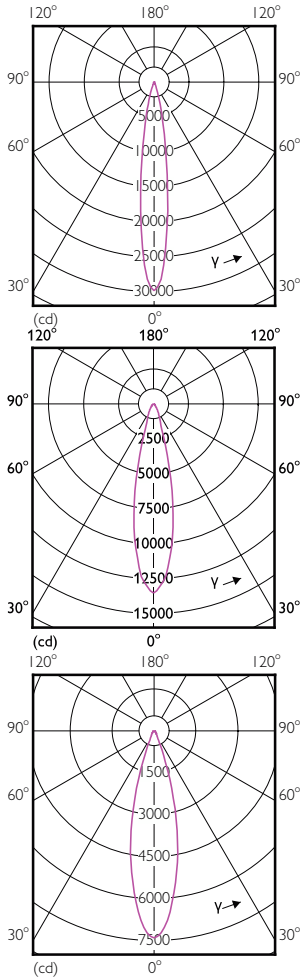

Accent Diagrams

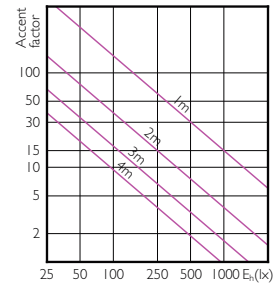
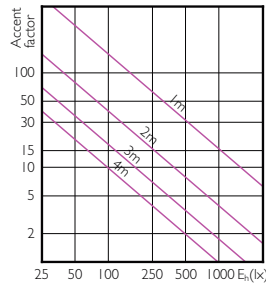
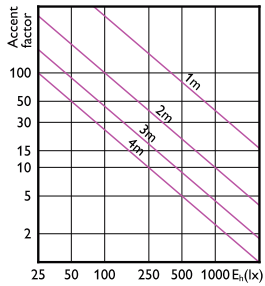

Accent Diagram - 33PAR38/PER/835/S15/DIM/
120V 6/1FB

Accent Diagram - Master LED PAR30L 40W
30D 840 CN

Accent Diagram - Master LED PAR30L 40W
30D 830 CN

MASTER LED spot PAR High Lumen

Accent Diagrams

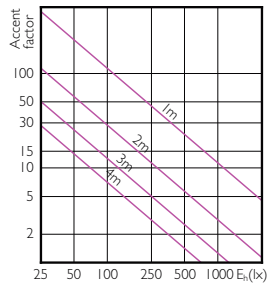

Accent Diagram - Master LED PAR30L 32W 30D 840

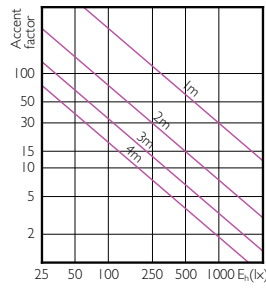

Accent Diagram - Master LED PAR30L 32W 15D 830 CN

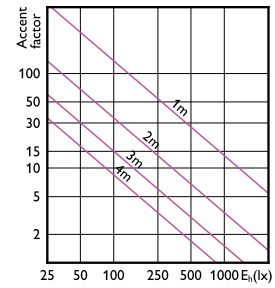

Accent Diagram - 33PAR38/PER/835/F25/DIM/120V 6/1FB

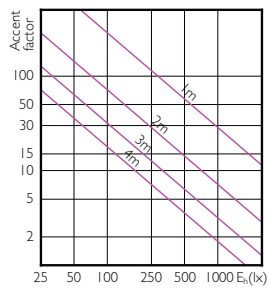

Accent Diagram - Master LED PAR30L 32W 15D 840 CN

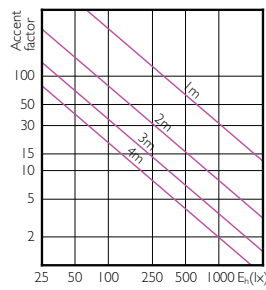

Accent Diagram - Master LED PAR30L 32W 15D 860 CN

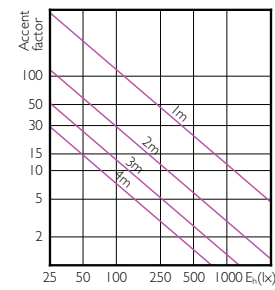

Accent Diagram - Master LED PAR30L 32W 30D 830

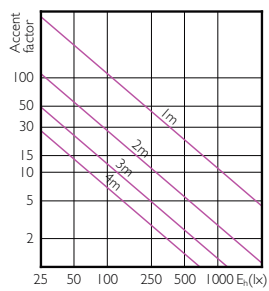

Accent Diagram - Master LED PAR30L 32W 30D 857

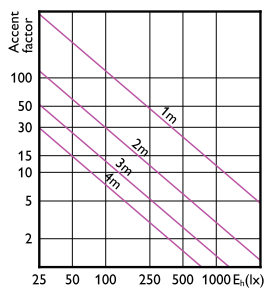

Accent Diagram - Master LED PAR30L 28W 30D 830 100-277V

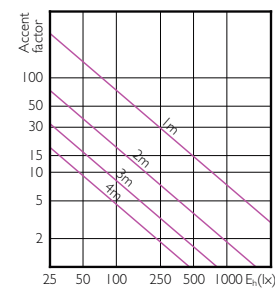

Accent Diagram - Master LED PAR30L 20W 30D 840

MASTER LED spot PAR High Lumen

Accent Diagrams

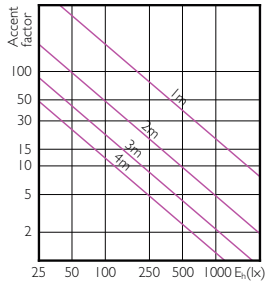

Accent Diagram - Master LED PAR30L 20W 15D 840 CN

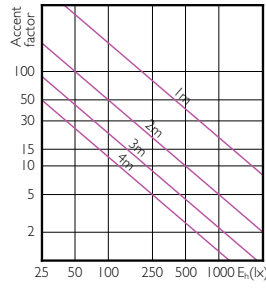

Accent Diagram - Master LED PAR30L 20W 15D 830

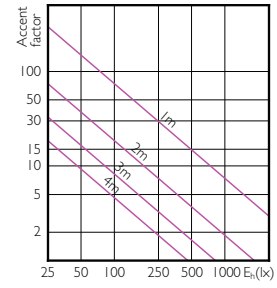

Accent Diagram - Master LED PAR30L 20W 30D 830 CN

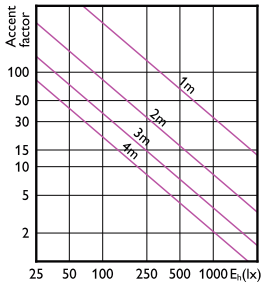

Accent Diagram - Master LED PAR30L 28W 15D 830 100-277V

Beam Diagrams

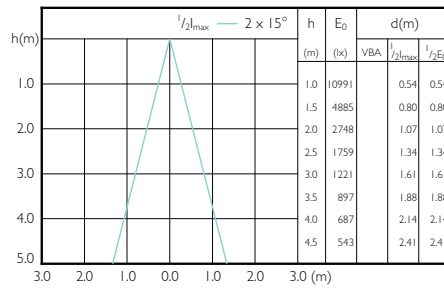

Beam diagram - Master LED PAR30L 32W 15D 830 CN

Beam diagram - Master LED PAR30L 32W 30D 857

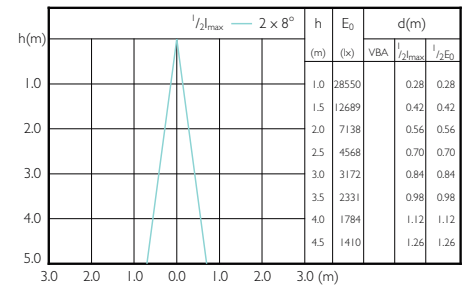

Beam diagram - Master LED PAR30L 32W 15D 840 CN

MASTER LED spot PAR High Lumen

Beam Diagrams

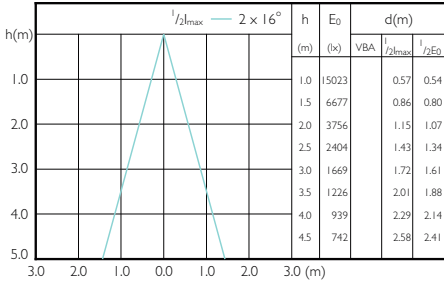

Beam diagram - Master LED PAR30L 40W 30D 830 CN

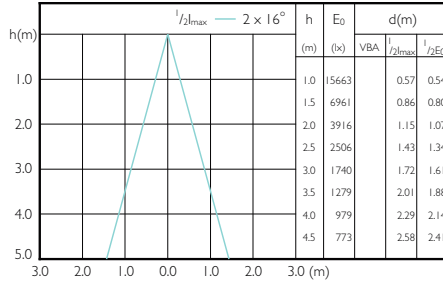

Beam diagram - Master LED PAR30L 40W 30D 840 CN

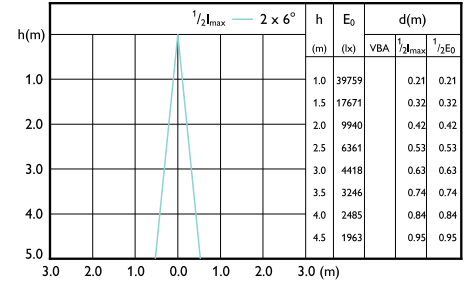

Beam diagram - 33PAR38/PER/835/S15/DIM/120V 6/1FB

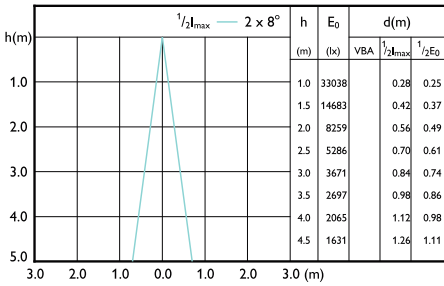

Beam diagram - Master LED PAR30L 28W 15D 830 100-277V



Beam diagram - Master LED PAR30L 20W 15D 840 CN

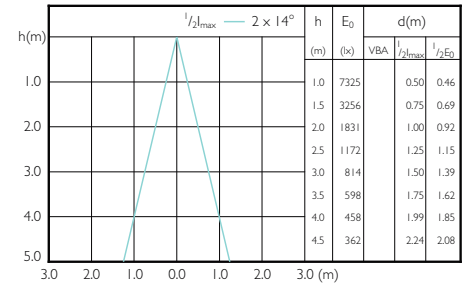

Beam diagram - Master LED PAR30L 20W 30D 840

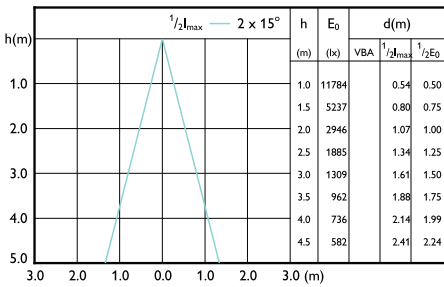

Beam diagram - Master LED PAR30L 28W 30D 830 100-277V

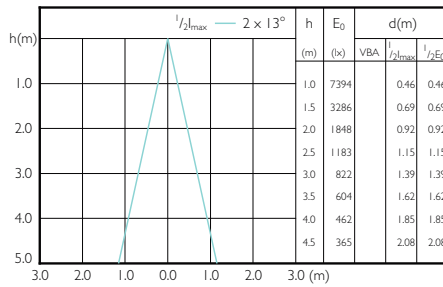

Beam diagram - Master LED PAR30L 20W 30D 830 CN

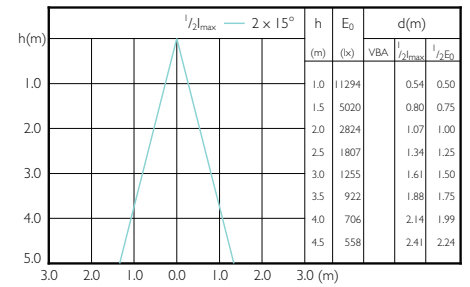

Beam diagram - Master LED PAR30L 32W 30D 840

MASTER LED spot PAR High Lumen

Beam Diagrams

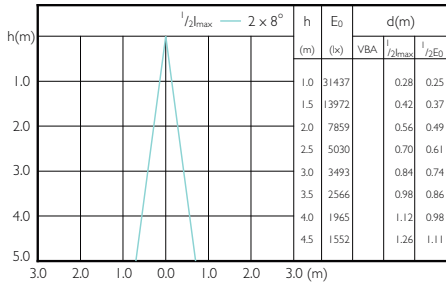

Beam diagram - Master LED PAR30L 32W 15D 860 CN

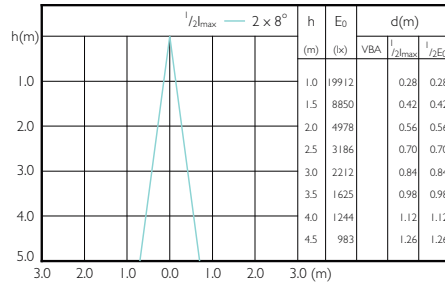

Beam diagram - Master LED PAR30L 20W 15D 830

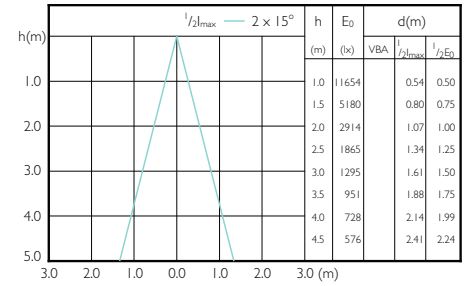

Beam diagram - Master LED PAR30L 32W 30D 830

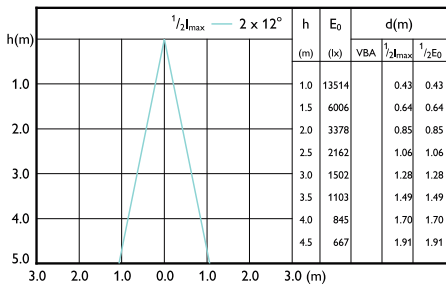

Beam diagram - 33PAR38/PER/835/F25/DIM/120V 6/1FB

