



# The affordable LEDspot solution

## CorePro LED spot Reflectors

CorePro LEDspots Reflectors are a perfect fit for spot lighting and deliver warm halogen-like light. They are compatible with most existing fixtures with an E27 or E14 base and are designed as a retrofit replacement for halogen or incandescent spots. CorePro LEDspots Reflectors deliver significant energy savings and minimise maintenance costs.

### Benefits

- Warm white light
- Up to 80% energy saving compared with halogen lamps
- Lower maintenance costs

### Features

- Easy retrofit
- Lifetime of 15,000 hours
- Compatible with an extensive range of dimmers
- UV- and IR-free light
- Free of mercury and hazardous materials – RoHS Compliant

### Application

- Hotels, restaurants, bars, cafés, museums, shops
- Lobbies, corridors, stairwells, washrooms, reception areas, exhibitions, display cabinets

# CorePro LED spot Reflectors

## Versions



LEDspot CorePro 60W E27 R80  
827 36D ND

## Dimensional drawing

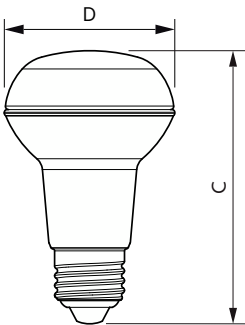
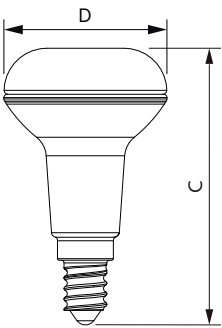
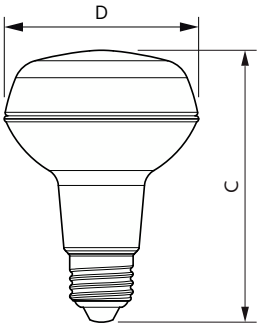

Product	D	C
CoreProLEDspot ND 4-60W R80 E27 827 36D	80 mm	112 mm
CoreProLEDspot ND 8-100W R80 E27 827 36D	80 mm	112 mm

Product	D	C
CoreProLEDspot D 4.3-60W R50 E14 827 36D	50 mm	84 mm
CoreProLEDspot ND2.8-40W R50 E14 827 36D	50 mm	84 mm

Product	D	C
CoreProLEDspot D 4.5-60W R63 E27 827 36D	63 mm	102 mm
CoreProLEDspot ND 3-40W R63 E27 827 36D	63 mm	102 mm

# CorePro LED spot Reflectors

## General Information

Switching Cycle	50,000
Nominal lifetime	15,000 h

## Light Technical

Beam angle (nom.)	36 degree(s)
Correlated Colour Temperature (Nom)	2700 K
Colour rendering index (CRI)	80
Colour Code	827
LLMF at end of nominal lifetime (nom.)	70 %

## Operating and Electrical

Input frequency	50 to 60 Hz
Line Frequency	50 to 60 Hz

## Mechanical and Housing

Lamp Finish	Clear
-------------	-------

## Approval and Application

Ambient temperature range	-20 to +45 °C
---------------------------	---------------

## General Information

Order Code	Full Product Name	Cap base
929001891102	CoreProLEDspot ND2.8-40W R50 E14 827 36D	E14
929001891202	CoreProLEDspot D 4.3-60W R50 E14 827 36D	E14
929001891502	CoreProLEDspot ND 4-60W R80 E27 827 36D	E27
929001891602	CoreProLEDspot ND 8-100W R80 E27 827 36D	E27
929001891302	CoreProLEDspot ND 3-40W R63 E27 827 36D	E27
929001891402	CoreProLEDspot D 4.5-60W R63 E27 827 36D	E27

## Light Technical

Order Code	Full Product Name	Luminous Flux	Luminous intensity (nom.)
929001891102	CoreProLEDspot ND2.8-40W R50 E14 827 36D	210 lm	400 cd
929001891202	CoreProLEDspot D 4.3-60W R50 E14 827 36D	320 lm	550 cd
929001891502	CoreProLEDspot ND 4-60W R80 E27 827 36D	345 lm	620 cd

Order Code	Full Product Name	Luminous Flux	Luminous intensity (nom.)
929001891602	CoreProLEDspot ND 8-100W R80 E27 827 36D	670 lm	1,100 cd
929001891302	CoreProLEDspot ND 3-40W R63 E27 827 36D	210 lm	400 cd
929001891402	CoreProLEDspot D 4.5-60W R63 E27 827 36D	345 lm	620 cd

## Operating and Electrical

Order Code	Full Product Name	Power Consumption	Starting time (nom.)	Wattage equivalent
929001891102	CoreProLEDspot ND2.8-40W R50 E14 827 36D	2.8 W	0.1 s	40 W
929001891202	CoreProLEDspot D 4.3-60W R50 E14 827 36D	4.3 W	0.5 s	60 W
929001891502	CoreProLEDspot ND 4-60W R80 E27 827 36D	4 W	0.1 s	60 W

Order Code	Full Product Name	Power Consumption	Starting time (nom.)	Wattage equivalent
929001891602	CoreProLEDspot ND 8-100W R80 E27 827 36D	8 W	0.1 s	100 W
929001891302	CoreProLEDspot ND 3-40W R63 E27 827 36D	3 W	0.1 s	40 W
929001891402	CoreProLEDspot D 4.5-60W R63 E27 827 36D	4.5 W	0.5 s	60 W

## Temperature

Order Code	Full Product Name	T-Case maximum (nom.)
929001891102	CoreProLEDspot ND2.8-40W R50 E14 827 36D	57 °C
929001891202	CoreProLEDspot D 4.3-60W R50 E14 827 36D	80 °C
929001891502	CoreProLEDspot ND 4-60W R80 E27 827 36D	50 °C

Order Code	Full Product Name	T-Case maximum (nom.)
929001891602	CoreProLEDspot ND 8-100W R80 E27 827 36D	72 °C
929001891302	CoreProLEDspot ND 3-40W R63 E27 827 36D	47 °C

# CorePro LED spot Reflectors

Order Code	Full Product Name	T-Case maximum (nom.)
929001891402	CoreProLEDspot D 4.5-60W R63 E27 827 36D	80 °C

## Controls and Dimming

Order Code	Full Product Name	Dimmable
929001891102	CoreProLEDspot ND2.8-40W R50 E14 827 36D	No
929001891202	CoreProLEDspot D 4.3-60W R50 E14 827 36D	Only with specific dimmers
929001891502	CoreProLEDspot ND 4-60W R80 E27 827 36D	No

Order Code	Full Product Name	Dimmable
929001891602	CoreProLEDspot ND 8-100W R80 E27 827 36D	No
929001891302	CoreProLEDspot ND 3-40W R63 E27 827 36D	No
929001891402	CoreProLEDspot D 4.5-60W R63 E27 827 36D	Only with specific dimmers

## Mechanical and Housing

Order Code	Full Product Name	Bulb shape
929001891102	CoreProLEDspot ND2.8-40W R50 E14 827 36D	R50
929001891202	CoreProLEDspot D 4.3-60W R50 E14 827 36D	R50
929001891502	CoreProLEDspot ND 4-60W R80 E27 827 36D	R80

Order Code	Full Product Name	Bulb shape
929001891602	CoreProLEDspot ND 8-100W R80 E27 827 36D	R80
929001891302	CoreProLEDspot ND 3-40W R63 E27 827 36D	R63
929001891402	CoreProLEDspot D 4.5-60W R63 E27 827 36D	R63

## Approval and Application

Order Code	Full Product Name	Energy consumption kWh/1,000 hours
929001891102	CoreProLEDspot ND2.8-40W R50 E14 827 36D	3 kWh
929001891202	CoreProLEDspot D 4.3-60W R50 E14 827 36D	5 kWh
929001891502	CoreProLEDspot ND 4-60W R80 E27 827 36D	4 kWh
929001891602	CoreProLEDspot ND 8-100W R80 E27 827 36D	8 kWh
929001891302	CoreProLEDspot ND 3-40W R63 E27 827 36D	3 kWh
929001891402	CoreProLEDspot D 4.5-60W R63 E27 827 36D	5 kWh

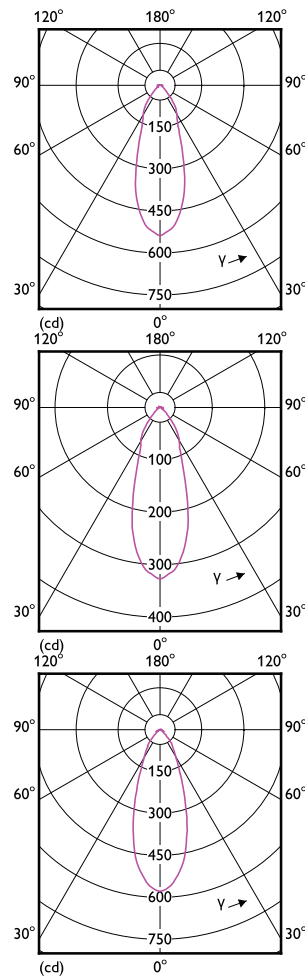
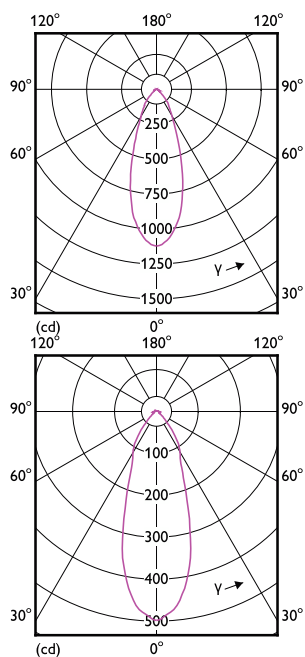

# CorePro LED spot Reflectors

## Accent Diagrams

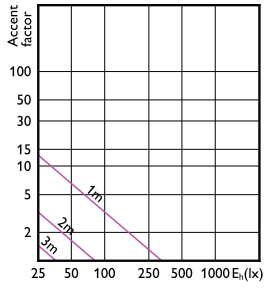

Accent Diagram - CoreProLEDspot ND 3-40W  
R63 E27 827 36D

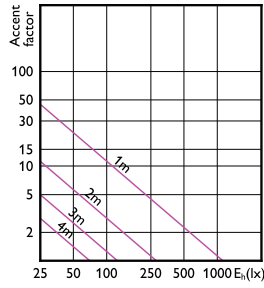

Accent Diagram - CoreProLEDspot ND 8-100W  
R80 E27 827 36D

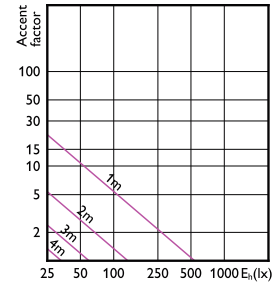

Accent Diagram - CoreProLEDspot D 4.5-60W  
R63 E27 827 36D

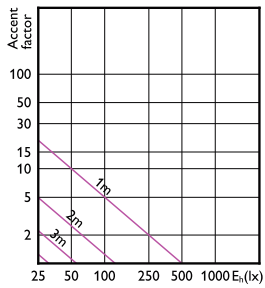

Accent Diagram - CoreProLEDspot D 4.3-60W  
R50 E14 827 36D

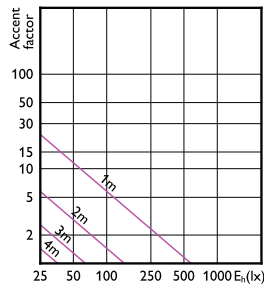

Accent Diagram - CoreProLEDspot ND 4-60W  
R80 E27 827 36D

## Beam Diagrams

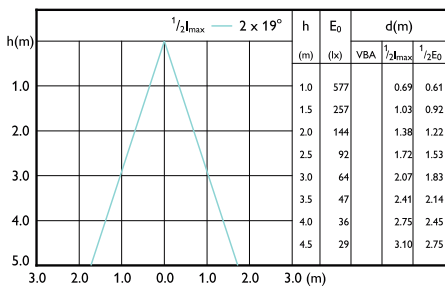

Beam diagram - CoreProLEDspot ND 4-60W  
R80 E27 827 36D

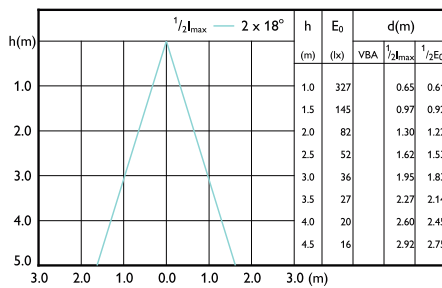

Beam diagram - CoreProLEDspot ND 3-40W  
R63 E27 827 36D

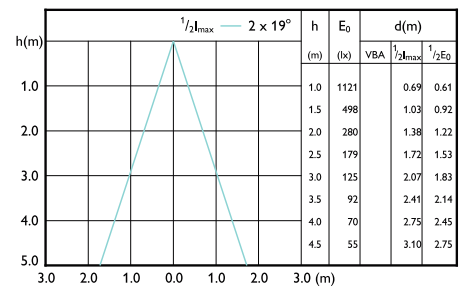

Beam diagram - CoreProLEDspot ND 8-100W  
R80 E27 827 36D

# CorePro LED spot Reflectors

## Beam Diagrams

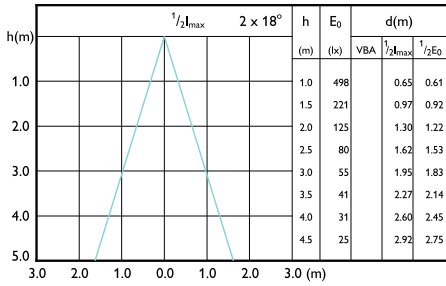

Beam diagram - CoreProLEDspot D 4.3-60W  
R50 E14 827 36D

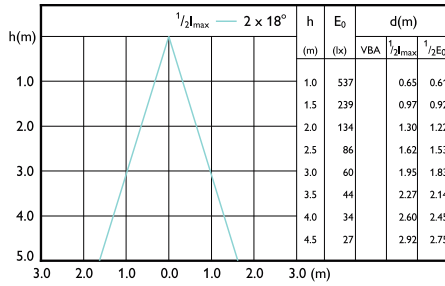

Beam diagram - CoreProLEDspot D 4.5-60W  
R63 E27 827 36D

