



The affordable LEDspot solution

CorePro LED spot Reflectors

CorePro LEDspots Reflectors are a perfect fit for spot lighting and deliver warm halogen-like light. They are compatible with most existing fixtures with a GU10 or E27 base and are designed as a retrofit replacement for halogen or incandescent spots. CorePro LEDspots Reflectors deliver significant energy savings and minimize maintenance cost.

Benefits

- Warm white light
- Up to 80% energy saving compared with halogen lamps
- Lower maintenance costs

Features

- Easy retrofit
- Lifetime of 15,000 hours
- Compatible with an extensive range of dimmers
- UV- and IR-free light
- Free of mercury and hazardous materials – RoHS Compliant

Application

- Hotels, restaurants, bars, cafés, museums, shops
- Lobbies, corridors, stairwells, washrooms, reception areas , exhibitions, display cabinets

CorePro LED spot Reflectors

Versions



LEDspot ESS 4W E14 R50 827-865
12D ND RCA



LEDspot ESS 7W E27 R63 827-865
12D ND RCA



LEDspot ESS 10W E27 R80
827-865 12D ND RCA



LEDspot CorePro 30W E14 R39
827 36D ND



LEDspot CorePro 25W E14 R50 827
36D ND



LEDspot CorePro 40W E27 R63
827 36D ND

Dimensional drawing

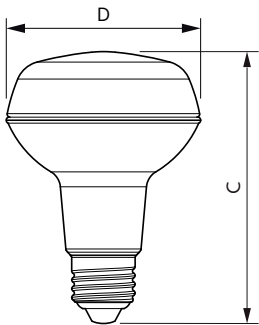

| Product | D | C |
|--|-------|--------|
| CoreProLEDspot ND 4-60W R80 E27 827 36D | 80 mm | 112 mm |
| CoreProLEDspot ND 8-100W R80 E27 827 36D | 80 mm | 112 mm |

CorePro LED spot Reflectors

Dimensional drawing

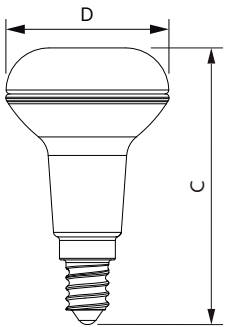
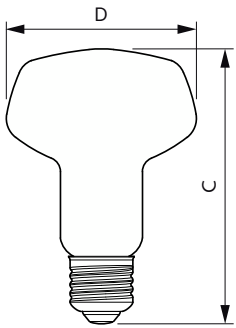
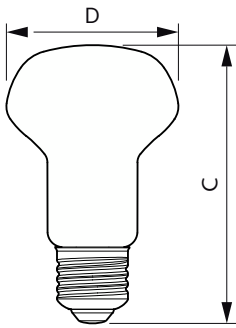
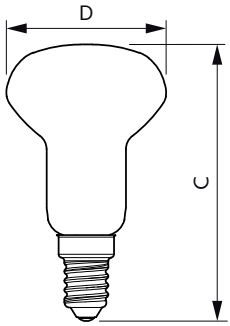

| Product | D | C |
|------------------------------|-------|-------|
| LED 4W E14 6500K 230V R50 AU | 50 mm | 86 mm |

| Product | D | C |
|------------------------------|-------|--------|
| LED 7W E27 6500K 230V R63 AU | 63 mm | 102 mm |

| Product | D | C |
|-----------------------------------|-------|--------|
| LED 10W E27 2700K 230V R80 2pk AU | 80 mm | 115 mm |
| LED 10W E27 2700K 230V R80 AU | 80 mm | 115 mm |
| LED 10W E27 6500K 230V R80 2pk AU | 80 mm | 115 mm |
| LED 10W E27 6500K 230V R80 AU | 80 mm | 115 mm |

| Product | D | C |
|--|-------|-------|
| CoreProLEDspot D 4.3-60W R50 E14 827 36D | 50 mm | 84 mm |
| CoreProLEDspot ND2.8-40W R50 E14 827 36D | 50 mm | 84 mm |

CorePro LED spot Reflectors

Dimensional drawing

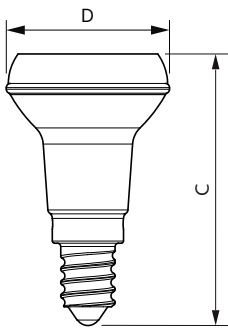
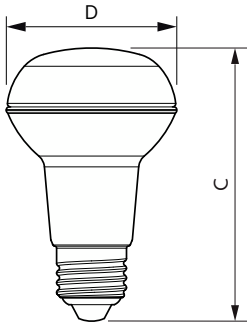

| Product | D | C |
|--|-------|--------|
| CoreProLEDspot D 4.5-60W R63 E27 827 36D | 63 mm | 102 mm |
| CoreProLEDspot ND 3-40W R63 E27 827 36D | 63 mm | 102 mm |

| Product | D | C |
|---------------------------|-------|-------|
| LEDspots 1.8W R39 827 E14 | 39 mm | 65 mm |

| General Information | |
|---------------------------------------|----------------|
| Switching Cycle | 50,000 |
| Nominal lifetime | 15,000 hour(s) |
| Light Technical | |
| Color rendering index (CRI) | 80 |
| LLMF At End Of Nominal Lifetime (Nom) | 70 % |
| Operating and Electrical | |
| Input Frequency | 50 to 60 Hz |
| Approval and Application | |
| Ambient temperature range | -20 to +45 °C |

General Information

| Order Code | Full Product Name | Cap-Base | Rated Lifetime (Hours) |
|--------------|-----------------------------------|----------|------------------------|
| 929001857519 | LED 4W E14 6500K 230V R50 AU | E14 | 15,000 hour(s) |
| 929001857819 | LED 7W E27 6500K 230V R63 AU | E27 | 15,000 hour(s) |
| 929001857919 | LED 10W E27 2700K 230V R80 AU | E27 | 15,000 hour(s) |
| 929001857979 | LED 10W E27 2700K 230V R80 2pk AU | E27 | 15,000 hour(s) |
| 929001858119 | LED 10W E27 6500K 230V R80 AU | E27 | 15,000 hour(s) |
| 929001858149 | LED 10W E27 6500K 230V R80 2pk AU | E27 | 15,000 hour(s) |
| 929001890991 | LEDspots 1.8W R39 827 E14 | E14 | 15,000 hour(s) |

| Order Code | Full Product Name | Cap-Base | Rated Lifetime (Hours) |
|--------------|--|----------|------------------------|
| 929001891102 | CoreProLEDspot ND2.8-40W R50 E14 827 36D | E14 | - |
| 929001891202 | CoreProLEDspot D 4.3-60W R50 E14 827 36D | E14 | - |
| 929001891502 | CoreProLEDspot ND 4-60W R80 E27 827 36D | E27 | - |
| 929001891602 | CoreProLEDspot ND 8-100W R80 E27 827 36D | E27 | - |

CorePro LED spot Reflectors

| Order Code | Full Product Name | Cap-Base | Rated Lifetime (Hours) |
|--------------|---|----------|------------------------|
| 929001891302 | CoreProLEDspot ND 3-40W R63 E27 827 36D | E27 | - |

| Order Code | Full Product Name | Cap-Base | Rated Lifetime (Hours) |
|--------------|--|----------|------------------------|
| 929001891402 | CoreProLEDspot D 4.5-60W R63 E27 827 36D | E27 | - |

Light Technical

| Order Code | Full Product Name | Beam Angle (Nom) | Correlated Color Temperature (Nom) | Color Code | Luminous Flux | Luminous Intensity (Nom) |
|--------------|--|------------------|------------------------------------|------------|---------------|--------------------------|
| 929001857519 | LED 4W E14 6500K 230V R50 AU | 120 degree(s) | 6500 K | 865 | 400 lm | - |
| 929001857819 | LED 7W E27 6500K 230V R63 AU | 120 degree(s) | 6500 K | 865 | 720 lm | - |
| 929001857919 | LED 10W E27 2700K 230V R80 AU | 120 degree(s) | 2700 K | 827 | 880 lm | - |
| 929001857979 | LED 10W E27 2700K 230V R80 2pk AU | 120 degree(s) | 2700 K | 827 | 880 lm | - |
| 929001858119 | LED 10W E27 6500K 230V R80 AU | 120 degree(s) | 6500 K | 865 | 950 lm | - |
| 929001858149 | LED 10W E27 6500K 230V R80 2pk AU | 120 degree(s) | 6500 K | 865 | 950 lm | - |
| 929001890991 | LEDspots 1.8W R39 827 E14 | 36 degree(s) | 2700 K | 827 | 190 lm | 250 cd |
| 929001891102 | CoreProLEDspot ND2.8-40W R50 E14 827 36D | 36 degree(s) | 2700 K | 827 | 210 lm | 400 cd |
| 929001891202 | CoreProLEDspot D 4.3-60W R50 E14 827 36D | 36 degree(s) | 2700 K | 827 | 320 lm | 550 cd |
| 929001891502 | CoreProLEDspot ND 4-60W R80 E27 827 36D | 36 degree(s) | 2700 K | 827 | 345 lm | 620 cd |
| 929001891602 | CoreProLEDspot ND 8-100W R80 E27 827 36D | 36 degree(s) | 2700 K | 827 | 670 lm | 1,100 cd |
| 929001891302 | CoreProLEDspot ND 3-40W R63 E27 827 36D | 36 degree(s) | 2700 K | 827 | 210 lm | 400 cd |
| 929001891402 | CoreProLEDspot D 4.5-60W R63 E27 827 36D | 36 degree(s) | 2700 K | 827 | 345 lm | 620 cd |

Operating and Electrical

| Order Code | Full Product Name | Line Frequency | Power Consumption | Starting | |
|--------------|-----------------------------------|----------------|-------------------|------------|--------------------|
| | | | | Time (Nom) | Wattage Equivalent |
| 929001857519 | LED 4W E14 6500K 230V R50 AU | - | 4 W | 0.5 s | 50 W |
| 929001857819 | LED 7W E27 6500K 230V R63 AU | - | 7 W | 0.5 s | 70 W |
| 929001857919 | LED 10W E27 2700K 230V R80 AU | - | 10 W | 0.5 s | 80 W |
| 929001857979 | LED 10W E27 2700K 230V R80 2pk AU | - | 10 W | 0.5 s | 80 W |
| 929001858119 | LED 10W E27 6500K 230V R80 AU | - | 10 W | 0.5 s | 80 W |
| 929001858149 | LED 10W E27 6500K 230V R80 2pk AU | - | 10 W | 0.5 s | 80 W |
| 929001890991 | LEDspots 1.8W R39 827 E14 | - | 1.8 W | 0.1 s | 30 W |

| Order Code | Full Product Name | Line Frequency | Power Consumption | Starting | |
|--------------|--|----------------|-------------------|------------|--------------------|
| | | | | Time (Nom) | Wattage Equivalent |
| 929001891102 | CoreProLEDspot ND2.8-40W R50 E14 827 36D | 50 to 60 Hz | 2.8 W | 0.1 s | 40 W |
| 929001891202 | CoreProLEDspot D 4.3-60W R50 E14 827 36D | 50 to 60 Hz | 4.3 W | 0.5 s | 60 W |
| 929001891502 | CoreProLEDspot ND 4-60W R80 E27 827 36D | 50 to 60 Hz | 4 W | 0.1 s | 60 W |
| 929001891602 | CoreProLEDspot ND 8-100W R80 E27 827 36D | 50 to 60 Hz | 8 W | 0.1 s | 100 W |
| 929001891302 | CoreProLEDspot ND 3-40W R63 E27 827 36D | 50 to 60 Hz | 3 W | 0.1 s | 40 W |
| 929001891402 | CoreProLEDspot D 4.5-60W R63 E27 827 36D | 50 to 60 Hz | 4.5 W | 0.5 s | 60 W |

Temperature

CorePro LED spot Reflectors

| Order Code | Full Product Name | T-Case Maximum (Nom) |
|--------------|-----------------------------------|----------------------|
| 929001857519 | LED 4W E14 6500K 230V R50 AU | 65 °C |
| 929001857819 | LED 7W E27 6500K 230V R63 AU | 68 °C |
| 929001857919 | LED 10W E27 2700K 230V R80 AU | 72 °C |
| 929001857979 | LED 10W E27 2700K 230V R80 2pk AU | 72 °C |
| 929001858119 | LED 10W E27 6500K 230V R80 AU | 72 °C |
| 929001858149 | LED 10W E27 6500K 230V R80 2pk AU | 72 °C |
| 929001890991 | LEDspots 1.8W R39 827 E14 | 50 °C |

| Order Code | Full Product Name | T-Case Maximum (Nom) |
|--------------|--|----------------------|
| 929001891102 | CoreProLEDspot ND2.8-40W R50 E14 827 36D | 57 °C |
| 929001891202 | CoreProLEDspot D 4.3-60W R50 E14 827 36D | 80 °C |
| 929001891502 | CoreProLEDspot ND 4-60W R80 E27 827 36D | 50 °C |
| 929001891602 | CoreProLEDspot ND 8-100W R80 E27 827 36D | 72 °C |
| 929001891302 | CoreProLEDspot ND 3-40W R63 E27 827 36D | 47 °C |
| 929001891402 | CoreProLEDspot D 4.5-60W R63 E27 827 36D | 80 °C |

Controls and Dimming

| Order Code | Full Product Name | Dimmable |
|--------------|--|----------|
| 929001857519 | LED 4W E14 6500K 230V R50 AU | No |
| 929001857819 | LED 7W E27 6500K 230V R63 AU | No |
| 929001857919 | LED 10W E27 2700K 230V R80 AU | No |
| 929001857979 | LED 10W E27 2700K 230V R80 2pk AU | No |
| 929001858119 | LED 10W E27 6500K 230V R80 AU | No |
| 929001858149 | LED 10W E27 6500K 230V R80 2pk AU | No |
| 929001890991 | LEDspots 1.8W R39 827 E14 | No |
| 929001891102 | CoreProLEDspot ND2.8-40W R50 E14 827 36D | No |

| Order Code | Full Product Name | Dimmable |
|--------------|--|----------------------------|
| 929001891202 | CoreProLEDspot D 4.3-60W R50 E14 827 36D | Only with specific dimmers |
| 929001891502 | CoreProLEDspot ND 4-60W R80 E27 827 36D | No |
| 929001891602 | CoreProLEDspot ND 8-100W R80 E27 827 36D | No |
| 929001891302 | CoreProLEDspot ND 3-40W R63 E27 827 36D | No |
| 929001891402 | CoreProLEDspot D 4.5-60W R63 E27 827 36D | Only with specific dimmers |

Mechanical and Housing

| Order Code | Full Product Name | Bulb Finish | Bulb Shape |
|--------------|--|-------------|------------|
| 929001857519 | LED 4W E14 6500K 230V R50 AU | Frosted | R50 |
| 929001857819 | LED 7W E27 6500K 230V R63 AU | Frosted | R63 |
| 929001857919 | LED 10W E27 2700K 230V R80 AU | Frosted | R80 |
| 929001857979 | LED 10W E27 2700K 230V R80 2pk AU | Frosted | R80 |
| 929001858119 | LED 10W E27 6500K 230V R80 AU | Frosted | R80 |
| 929001858149 | LED 10W E27 6500K 230V R80 2pk AU | Frosted | R80 |
| 929001890991 | LEDspots 1.8W R39 827 E14 | Clear | R39 |
| 929001891102 | CoreProLEDspot ND2.8-40W R50 E14 827 36D | Clear | R50 |

| Order Code | Full Product Name | Bulb Finish | Bulb Shape |
|--------------|--|-------------|------------|
| 929001891202 | CoreProLEDspot D 4.3-60W R50 E14 827 36D | Clear | R50 |
| 929001891502 | CoreProLEDspot ND 4-60W R80 E27 827 36D | Clear | R80 |
| 929001891602 | CoreProLEDspot ND 8-100W R80 E27 827 36D | Clear | R80 |
| 929001891302 | CoreProLEDspot ND 3-40W R63 E27 827 36D | Clear | R63 |
| 929001891402 | CoreProLEDspot D 4.5-60W R63 E27 827 36D | Clear | R63 |

Approval and Application

| Order Code | Full Product Name | Energy Consumption kWh/1000 h |
|--------------|--|-------------------------------|
| 929001857519 | LED 4W E14 6500K 230V R50 AU | 4 kWh |
| 929001857819 | LED 7W E27 6500K 230V R63 AU | 7 kWh |
| 929001857919 | LED 10W E27 2700K 230V R80 AU | 10 kWh |
| 929001857979 | LED 10W E27 2700K 230V R80 2pk AU | 10 kWh |
| 929001858119 | LED 10W E27 6500K 230V R80 AU | 10 kWh |
| 929001858149 | LED 10W E27 6500K 230V R80 2pk AU | 10 kWh |
| 929001890991 | LEDspots 1.8W R39 827 E14 | 2 kWh |
| 929001891102 | CoreProLEDspot ND2.8-40W R50 E14 827 36D | 3 kWh |
| 929001891202 | CoreProLEDspot D 4.3-60W R50 E14 827 36D | 5 kWh |
| 929001891502 | CoreProLEDspot ND 4-60W R80 E27 827 36D | 4 kWh |
| 929001891602 | CoreProLEDspot ND 8-100W R80 E27 827 36D | 8 kWh |
| 929001891302 | CoreProLEDspot ND 3-40W R63 E27 827 36D | 3 kWh |

| Order Code | Full Product Name | Energy Consumption kWh/1000 h |
|--------------|--|-------------------------------|
| 929001891402 | CoreProLEDspot D 4.5-60W R63 E27 827 36D | 5 kWh |

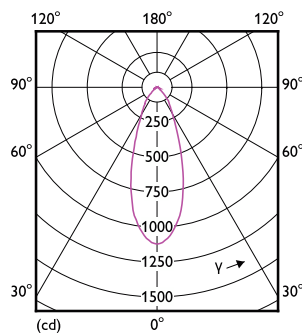

CorePro LED spot Reflectors

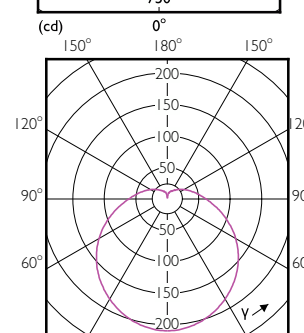
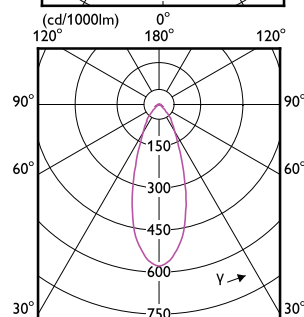
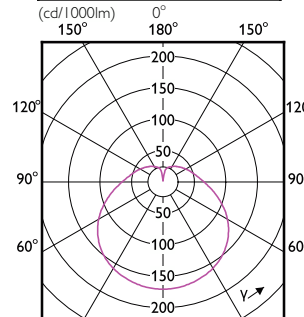
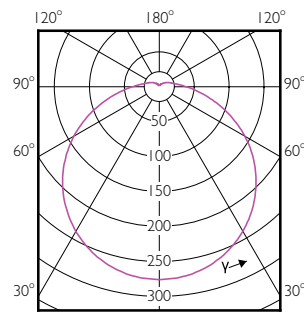
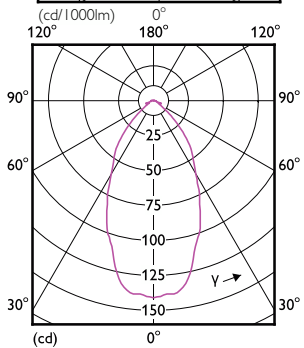
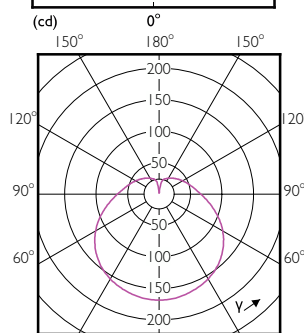
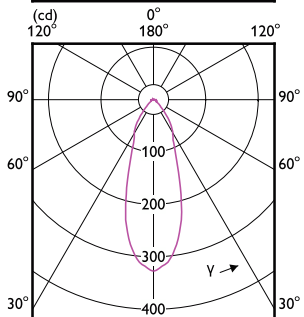
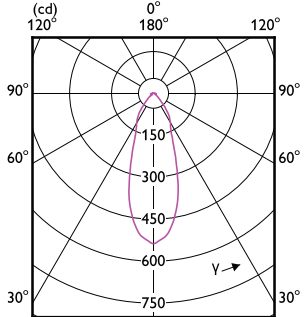
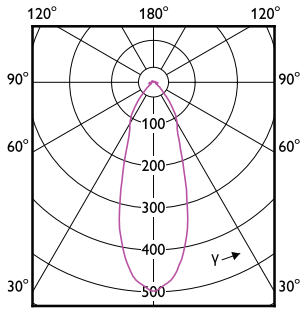

CorePro LED spot Reflectors

Accent Diagrams

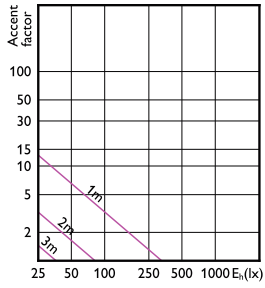

Accent Diagram - CoreProLEDspot ND 3-40W
R63 E27 827 36D

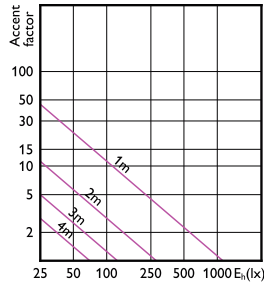

Accent Diagram - CoreProLEDspot ND 8-100W
R80 E27 827 36D

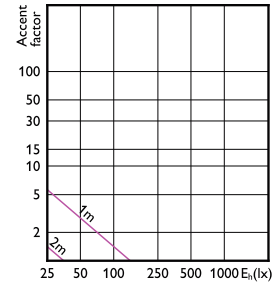

Accent Diagram - LEDspots 1.8W R39 827 E14

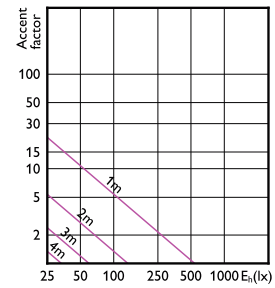

Accent Diagram - CoreProLEDspot D 4.5-60W
R63 E27 827 36D

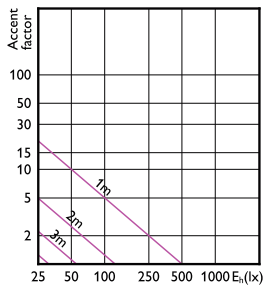

Accent Diagram - CoreProLEDspot D 4.3-60W
R50 E14 827 36D

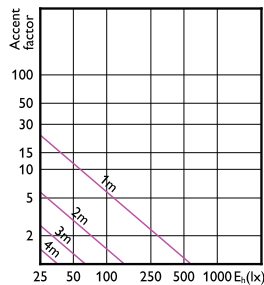

Accent Diagram - CoreProLEDspot ND 4-60W
R80 E27 827 36D

CorePro LED spot Reflectors

Beam Diagrams

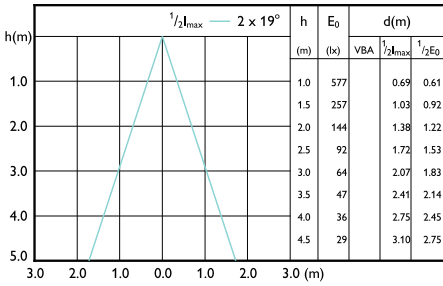

Beam diagram - CoreProLEDspot ND 4-60W
R80 E27 827 36D

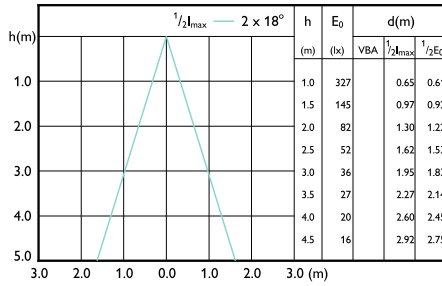

Beam diagram - CoreProLEDspot ND 3-40W
R63 E27 827 36D

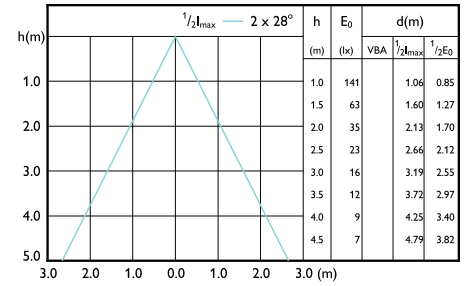

Beam diagram - LEDspots 1.8W R39 827 E14

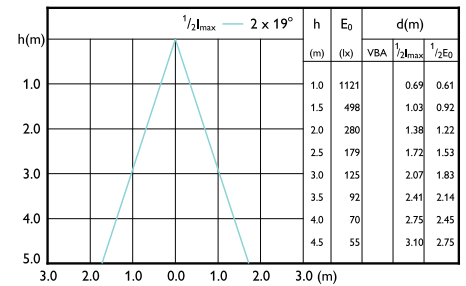

Beam diagram - CoreProLEDspot ND 8-100W
R80 E27 827 36D

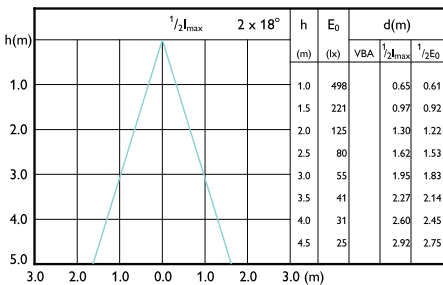

Beam diagram - CoreProLEDspot D 4.3-60W
R50 E14 827 36D

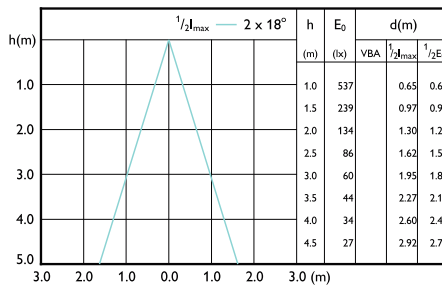

Beam diagram - CoreProLEDspot D 4.5-60W
R63 E27 827 36D

