



# La mejor solución LED para el reemplazo de lámparas de descarga de alta intensidad (HID)

## LED TrueForce Core industrial y comercial (Gran altura – HPI/SON/HPL)

Las lámparas Philips TrueForce Core LED I&R son una solución LED fácil y de rápida recuperación para reemplazar lámparas de descarga de alta intensidad (HID, por sus siglas en inglés). Este producto trae consigo las ventajas del ahorro de energía y de la larga vida útil de los LED como reemplazo de HID y proporciona ahorros instantáneos con una baja inversión inicial. Gracias al tamaño adecuado de la lámpara y su distribución de luz, es muy fácil retroadaptar las lámparas TrueForce Core LED I&R y derivar el balasto existente, al mismo tiempo que se mejora la calidad de la iluminación.

### Beneficios

- Ahorro de costos con un mínimo tiempo de recuperación
- Iluminación en el espacio de trabajo más amplio
- Baja inversión inicial
- Mejora la calidad de la iluminación con integración sencilla

## LED TrueForce Core industrial y comercial (Gran altura – HPI/SON/HPL)

### Características

- Gran eficacia energética
- Vida útil de 20.000 horas
- Ángulo de haz de luz ancho de 240°
- Derive el balasto y ahorre energía adicional
- Agradable luz de color blanco con CRI 80

### Aplicaciones

- Industrial/tiendas minoristas: depósitos, fábricas, tiendas, centros de transporte

### Versions



Product standard image



LEDTrueForce Core HB Tshape E40 1



Product standard image



Product standard image



Product standard image



LEDTrueForce Core HB Tshape E40



Product standard image



Product standard image

### Plano de dimensiones

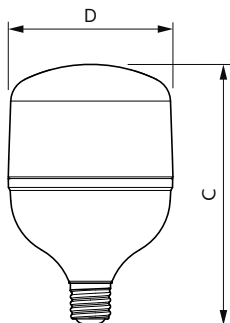

Product	D	C
TForce Core HB 80W E40 865 WV G3	160 mm	269 mm

# LED TrueForce Core industrial y comercial (Gran altura – HPI/SON/HPL)

## Plano de dimensiones

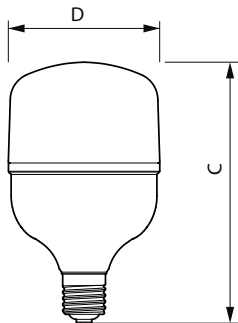

Product	D	C
TForce Core HB 4Klm 50W E40 865 WV	120 mm	199 mm

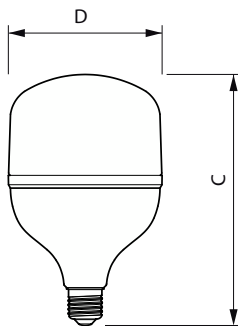

Product	D	C
TForce Core HB 4Klm 50W E27 865 WV	120 mm	196 mm

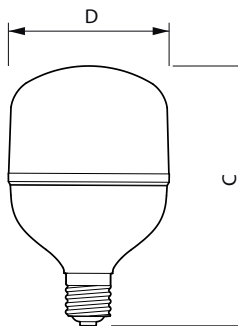

Product	D	C
TForce Core HB 5Klm 60W E40 865 WV	140 mm	227 mm

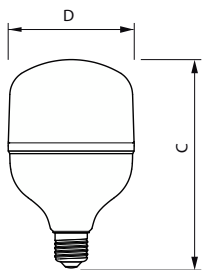

Product	D	C
TForce Core HB 3Klm 40W E27 865 WV	102 mm	168 mm

# LED TrueForce Core industrial y comercial (Gran altura – HPI/SON/HPL)

## Plano de dimensiones

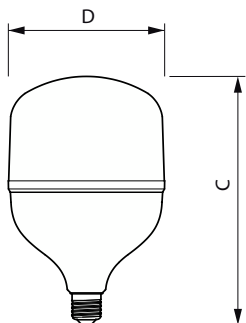

Product	D	C
TForce Core HB 5Klm 60W E27 865 WV	140 mm	224 mm

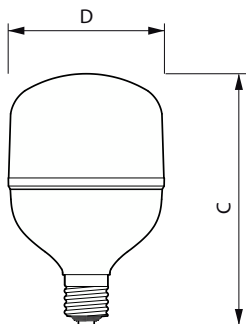

Product	D	C
TForce Core HB 60W E40 865 WV G3	140 mm	227 mm

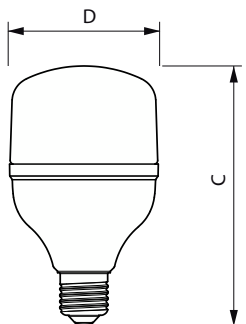

Product	D	C
TForce Core HB 2.5Klm 30W E27 865 WV	82 mm	143 mm

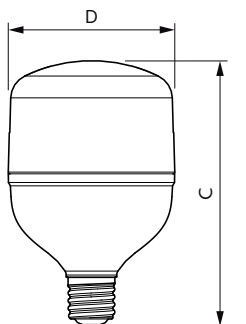

Product	D	C
TForce Core HB 60W E40 865 WV G3	140 mm	224 mm

# LED TrueForce Core industrial y comercial (Gran altura – HPI/SON/HPL)

## Plano de dimensiones

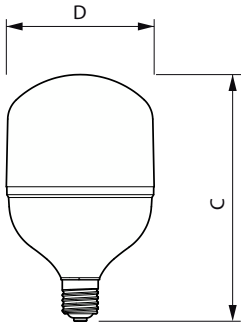

Product	D	C
TForce Core HB 80W E40 865 WV G3	162 mm	271 mm

Información general	
Ciclo del interruptor	50.000
Información técnica sobre la luz	
Ángulo de haz (nominal)	150 °
Temperatura de color correlacionada (nominal)	6500 K
Índice de producción de color (IRC)	80
Código de color	865
LLMF al final de la vida útil nominal (nominal)	70 %
Operación y aspectos eléctricos	
Frecuencia de entrada	50 a 60 Hz
Tiempo de inicio (nominal)	0,5 s
Controles y atenuación	
Regulable	No
Mecánica y carcasa	
Acabado de la luz	Blanco
Aprobación y aplicación	
Rango de temperatura ambiente	-20 a +45 °C

## Información general

Order Code	Full Product Name	Tapa-base	Vida útil nominal
929003759342	TForce Core HB 5Klm 60W E27 865 WV	E27	15.000 hora(s)
929002409912	TForce Core HB 80W E40 865 WV G3	E40	25.000 hora(s)
929003759442	TForce Core HB 5Klm 60W E40 865 WV	E40	15.000 hora(s)
929003759142	TForce Core HB 3Klm 40W E27 865 WV	E27	15.000 hora(s)
929003792642	TForce Core HB 4Klm 50W E40 865 WV	E40	15.000 hora(s)
929002409612	TForce Core HB 60W E40 865 WV G3	E40	25.000 hora(s)
929003759242	TForce Core HB 4Klm 50W E27 865 WV	E27	15.000 hora(s)
929003759042	TForce Core HB 2.5Klm 30W E27 865 WV	E27	15.000 hora(s)

## Información técnica sobre la luz

Order Code	Full Product Name	Flujo luminoso
929003759342	TForce Core HB 5Klm 60W E27 865 WV	5.000 lm
929002409912	TForce Core HB 80W E40 865 WV G3	9.000 lm
929003759442	TForce Core HB 5Klm 60W E40 865 WV	5.000 lm
929003759142	TForce Core HB 3Klm 40W E27 865 WV	3.000 lm

Order Code	Full Product Name	Flujo luminoso
929003792642	TForce Core HB 4Klm 50W E40 865 WV	4.000 lm
929002409612	TForce Core HB 60W E40 865 WV G3	7.000 lm
929003759242	TForce Core HB 4Klm 50W E27 865 WV	4.000 lm
929003759042	TForce Core HB 2.5Klm 30W E27 865 WV	2.500 lm

## Operación y aspectos eléctricos

# LED TrueForce Core industrial y comercial (Gran altura – HPI/SON/HPL)

Order Code	Full Product Name	Frecuencia de línea	Consumo de energía
929003759342	TForce Core HB 5Klm 60W E27 865 WV	-	60 W
929002409912	TForce Core HB 80W E40 865 WV G3	50 to 60 Hz	80 W
929003759442	TForce Core HB 5Klm 60W E40 865 WV	-	60 W
929003759142	TForce Core HB 3Klm 40W E27 865 WV	-	40 W

Order Code	Full Product Name	Frecuencia de línea	Consumo de energía
929003792642	TForce Core HB 4Klm 50W E40 865 WV	-	50 W
929002409612	TForce Core HB 60W E40 865 WV G3	50 to 60 Hz	60 W
929003759242	TForce Core HB 4Klm 50W E27 865 WV	-	50 W
929003759042	TForce Core HB 2.5Klm 30W E27 865 WV	-	30 W

## Temperatura

Order Code	Full Product Name	T° estuche máxima (nominal)
929003759342	TForce Core HB 5Klm 60W E27 865 WV	78 °C
929002409912	TForce Core HB 80W E40 865 WV G3	83 °C
929003759442	TForce Core HB 5Klm 60W E40 865 WV	78 °C
929003759142	TForce Core HB 3Klm 40W E27 865 WV	79 °C

Order Code	Full Product Name	T° estuche máxima (nominal)
929003792642	TForce Core HB 4Klm 50W E40 865 WV	81 °C
929002409612	TForce Core HB 60W E40 865 WV G3	79 °C
929003759242	TForce Core HB 4Klm 50W E27 865 WV	81 °C
929003759042	TForce Core HB 2.5Klm 30W E27 865 WV	88 °C

## Mecánica y carcasa

Order Code	Full Product Name	Forma del foco
929003759342	TForce Core HB 5Klm 60W E27 865 WV	T140 en forma de T
929002409912	TForce Core HB 80W E40 865 WV G3	T160 en forma de T
929003759442	TForce Core HB 5Klm 60W E40 865 WV	T140 en forma de T
929003759142	TForce Core HB 3Klm 40W E27 865 WV	T120 en forma de T

Order Code	Full Product Name	Forma del foco
929003792642	TForce Core HB 4Klm 50W E40 865 WV	T120 en forma de T
929002409612	TForce Core HB 60W E40 865 WV G3	T160 en forma de T
929003759242	TForce Core HB 4Klm 50W E27 865 WV	T120 en forma de T
929003759042	TForce Core HB 2.5Klm 30W E27 865 WV	T80 en forma de T

## Aprobación y aplicación

Order Code	Full Product Name	Consumo energético kWh/1000 h
929003759342	TForce Core HB 5Klm 60W E27 865 WV	60 kWh
929002409912	TForce Core HB 80W E40 865 WV G3	80 kWh
929003759442	TForce Core HB 5Klm 60W E40 865 WV	60 kWh
929003759142	TForce Core HB 3Klm 40W E27 865 WV	40 kWh
929003792642	TForce Core HB 4Klm 50W E40 865 WV	50 kWh
929002409612	TForce Core HB 60W E40 865 WV G3	60 kWh
929003759242	TForce Core HB 4Klm 50W E27 865 WV	50 kWh
929003759042	TForce Core HB 2.5Klm 30W E27 865 WV	30 kWh

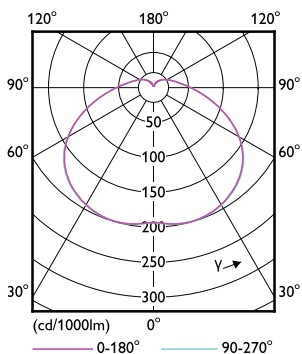
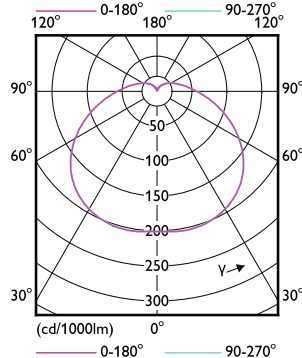
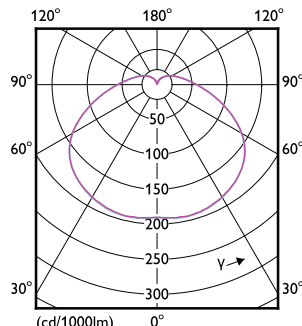

# LED TrueForce Core industrial y comercial (Gran altura – HPI/SON/HPL)

