



La mejor solución LED para el reemplazo de lámparas de descarga de alta intensidad (HID)

LED TrueForce Core industrial y comercial (Gran altura – HPI/SON/HPL)

Las lámparas Philips TrueForce Core LED I&R son una solución LED fácil y de rápida recuperación para reemplazar lámparas de descarga de alta intensidad (HID, por sus siglas en inglés). Este producto trae consigo las ventajas del ahorro de energía y de la larga vida útil de los LED como reemplazo de HID y proporciona ahorros instantáneos con una baja inversión inicial. Gracias al tamaño adecuado de la lámpara y su distribución de luz, es muy fácil retroadaptar las lámparas TrueForce Core LED I&R y derivar el balasto existente, al mismo tiempo que se mejora la calidad de la iluminación.

Beneficios

- Ahorro de costos con un mínimo tiempo de recuperación
- Iluminación en el espacio de trabajo más amplio
- Baja inversión inicial
- Mejora la calidad de la iluminación con integración sencilla

LED TrueForce Core industrial y comercial (Gran altura – HPI/SON/HPL)

Características

- Gran eficacia energética
- Vida útil de 20.000 horas
- Ángulo de haz de luz ancho de 240°
- Derive el balasto y ahorre energía adicional
- Agradable luz de color blanco con CRI 80

Aplicaciones

- Industrial/tiendas minoristas: depósitos, fábricas, tiendas, centros de transporte

Versions



LED TForce Core HB Tshape E40 1



LED TForce Core HB 3 5Klm 40W E27 865



Product standard image



Product standard image



LED TForce Core HB 4 5Klm 50W E27 865



LED TForce Core HB 2Klm 23W E27 865



LED-TForce-Core-HB-5-5Klm-60W-E27-865



Product standard image

Plano de dimensiones

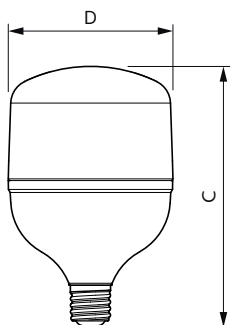

Product	D	C
TForce Core HB 80W E40 865 WV G3	160 mm	269 mm

LED TrueForce Core industrial y comercial (Gran altura – HPI/SON/HPL)

Plano de dimensiones

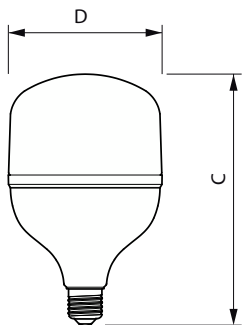

Product	D	C
TForce Core HB 4Klm 40W E27 865 WV	120 mm	196 mm

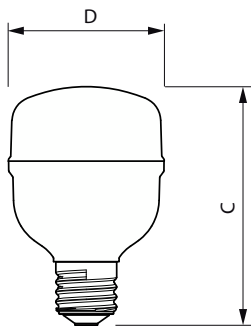

Product	D	C
TForce Core HB 4Klm 50W E40 865 WV	100 mm	158 mm

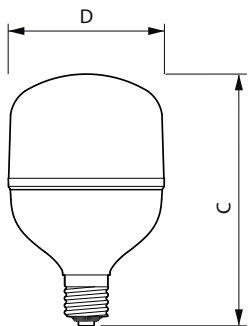

Product	D	C
TForce Core HB 60W E40 865 WV G3	140 mm	227 mm

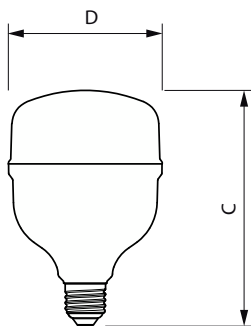

Product	D	C
TForce Core HB 3.5Klm 40W E27 865	100 mm	152 mm

LED TrueForce Core industrial y comercial (Gran altura – HPI/SON/HPL)

Plano de dimensiones

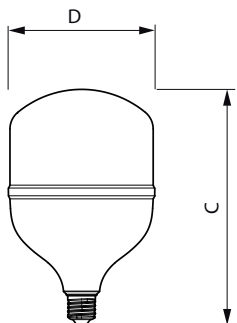

Product	D	C
TForce Core HB 5.5Klm 60W E27 865	137 mm	190 mm

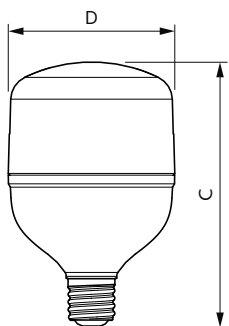

Product	D	C
TForce Core HB 50W E40 865 WV G3	140 mm	224 mm
TForce Core HB 60W E40 865 WV G3	140 mm	224 mm

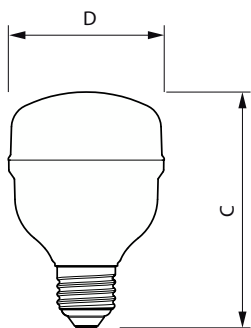

Product	D	C
TForce Core HB 2Klm 23W E27 865	70 mm	106 mm

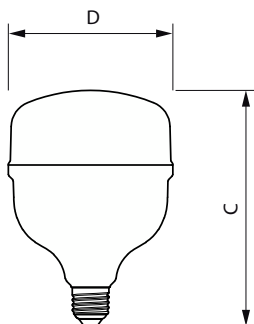

Product	D	C
TForce Core HB 4.5Klm 50W E27 865	119 mm	167 mm

LED TrueForce Core industrial y comercial (Gran altura – HPI/SON/HPL)

Plano de dimensiones

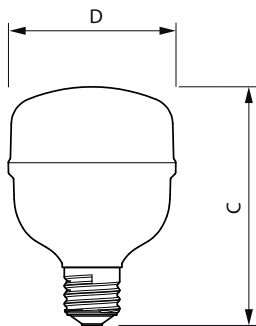
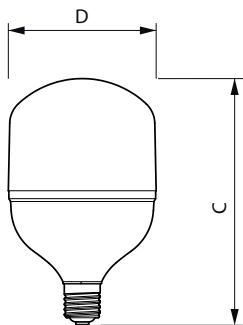

Product	D	C
TForce Core HB 80W E40 865 WV G3	162 mm	271 mm

Product	D	C
TForce Core HB 5Klm 60W E40 865 WV	118 mm	173 mm

Información general

Ciclo del interruptor	50.000
-----------------------	--------

Información técnica sobre la luz

Temperatura de color correlacionada (nominal)	6500 K
---	--------

Índice de producción de color (IRC)	80
-------------------------------------	----

Código de color	865
-----------------	-----

LLMF al final de la vida útil nominal (nominal)	70 %
---	------

Operación y aspectos eléctricos

Frecuencia de entrada	50 a 60 Hz
-----------------------	------------

Tiempo de inicio (nominal)	0,5 s
----------------------------	-------

Controles y atenuación

Regulable	No
-----------	----

Información general

Order Code	Full Product Name	Tapa-base	Vida útil nominal
929002409912	TForce Core HB 80W E40 865 WV G3	E40	25.000 hora(s)
929004612312	TForce Core HB 3.5Klm 40W E27 865	E27	15.000 hora(s)
929004271642	TForce Core HB 5Klm 60W E40 865 WV	E40	15.000 hora(s)
929004271542	TForce Core HB 4Klm 50W E40 865 WV	E40	15.000 hora(s)
929004612412	TForce Core HB 4.5Klm 50W E27 865	E27	15.000 hora(s)
929004612112	TForce Core HB 2Klm 23W E27 865	E27	15.000 hora(s)
929004345512	TForce Core HB 5.5Klm 60W E27 865	E27	15.000 hora(s)
929002409612	TForce Core HB 60W E40 865 WV G3	E40	25.000 hora(s)
929002410412	TForce Core HB 50W E40 865 WV G3	E40	15.000 hora(s)
929003759212	TForce Core HB 4Klm 40W E27 865 WV	E27	15.000 hora(s)

Información técnica sobre la luz

Order Code	Full Product Name	Ángulo de haz (nominal)	Flujo luminoso
929002409912	TForce Core HB 80W E40 865 WV G3	150 °	9.000 lm
929004612312	TForce Core HB 3.5Klm 40W E27 865	150 °	3.500 lm

Order Code	Full Product Name	Ángulo de haz (nominal)	Flujo luminoso
929004271642	TForce Core HB 5Klm 60W E40 865 WV	150 °	5.000 lm
929004271542	TForce Core HB 4Klm 50W E40 865 WV	150 °	4.000 lm

LED TrueForce Core industrial y comercial (Gran altura – HPI/SON/HPL)

Order Code	Full Product Name	Ángulo de haz (nominal)	Flujo luminoso
929004612412	TForce Core HB 4.5Klm 50W E27 865	150 °	4.500 lm
929004612112	TForce Core HB 2Klm 23W E27 865	150 °	2.000 lm
929004345512	TForce Core HB 5.5Klm 60W E27 865	150 °	5.500 lm
929002409612	TForce Core HB 60W E40 865 WV G3	150 °	7.000 lm

Order Code	Full Product Name	Ángulo de haz (nominal)	Flujo luminoso
929002410412	TForce Core HB 50W E40 865 WV G3	180 °	5.000 lm
929003759212	TForce Core HB 4Klm 40W E27 865 WV	150 °	4.000 lm

Operación y aspectos eléctricos

Order Code	Full Product Name	Frecuencia de línea	Consumo de energía
929002409912	TForce Core HB 80W E40 865 WV G3	50 to 60 Hz	80 W
929004612312	TForce Core HB 3.5Klm 40W E27 865	-	40 W
929004271642	TForce Core HB 5Klm 60W E40 865 WV	-	60 W
929004271542	TForce Core HB 4Klm 50W E40 865 WV	-	50 W
929004612412	TForce Core HB 4.5Klm 50W E27 865	-	50 W

Order Code	Full Product Name	Frecuencia de línea	Consumo de energía
929004612112	TForce Core HB 2Klm 23W E27 865	-	23 W
929004345512	TForce Core HB 5.5Klm 60W E27 865	-	60 W
929002409612	TForce Core HB 60W E40 865 WV G3	50 to 60 Hz	60 W
929002410412	TForce Core HB 50W E40 865 WV G3	50 to 60 Hz	50 W
929003759212	TForce Core HB 4Klm 40W E27 865 WV	-	40 W

Temperatura

Order Code	Full Product Name	T° estuche máxima (nominal)
929002409912	TForce Core HB 80W E40 865 WV G3	83 °C
929004612312	TForce Core HB 3.5Klm 40W E27 865	86 °C
929004271642	TForce Core HB 5Klm 60W E40 865 WV	75 °C
929004271542	TForce Core HB 4Klm 50W E40 865 WV	75 °C
929004612412	TForce Core HB 4.5Klm 50W E27 865	83 °C

Order Code	Full Product Name	T° estuche máxima (nominal)
929004612112	TForce Core HB 2Klm 23W E27 865	88 °C
929004345512	TForce Core HB 5.5Klm 60W E27 865	80 °C
929002409612	TForce Core HB 60W E40 865 WV G3	79 °C
929002410412	TForce Core HB 50W E40 865 WV G3	78 °C
929003759212	TForce Core HB 4Klm 40W E27 865 WV	81 °C

Mecánica y carcasa

Order Code	Full Product Name	Acabado de la luz	Forma del foco
929002409912	TForce Core HB 80W E40 865 WV G3	Blanco	T160 en forma de T
929004612312	TForce Core HB 3.5Klm 40W E27 865	Blanco	T100 en forma de T
929004271642	TForce Core HB 5Klm 60W E40 865 WV	Blanco	T120 en forma de T
929004271542	TForce Core HB 4Klm 50W E40 865 WV	Blanco	T100 en forma de T
929004612412	TForce Core HB 4.5Klm 50W E27 865	Blanco	T120 en forma de T

Order Code	Full Product Name	Acabado de la luz	Forma del foco
929004612112	TForce Core HB 2Klm 23W E27 865	Blanco	T70 en forma de T
929004345512	TForce Core HB 5.5Klm 60W E27 865	-	T140 en forma de T
929002409612	TForce Core HB 60W E40 865 WV G3	Blanco	T160 en forma de T
929002410412	TForce Core HB 50W E40 865 WV G3	Blanco	Forma de T
929003759212	TForce Core HB 4Klm 40W E27 865 WV	Blanco	T120

Aprobación y aplicación

LED TrueForce Core industrial y comercial (Gran altura – HPI/SON/HPL)

Order Code	Full Product Name	Rango de temperatura ambiente	Consumo energético kWh/1000 h
929002409912	TForce Core HB 80W E40 865 WV G3	-20 a +45 °C	80 kWh
929004612312	TForce Core HB 3.5Klm 40W E27 865	-20 a +45 °C	40 kWh
929004271642	TForce Core HB 5Klm 60W E40 865 WV	-20 a +45 °C	60 kWh
929004271542	TForce Core HB 4Klm 50W E40 865 WV	-20 a +45 °C	50 kWh
929004612412	TForce Core HB 4.5Klm 50W E27 865	-20 a +45 °C	50 kWh
929004612112	TForce Core HB 2Klm 23W E27 865	-20 a +45 °C	23 kWh
929004345512	TForce Core HB 5.5Klm 60W E27 865	-20 a +45 °C	60 kWh
929002409612	TForce Core HB 60W E40 865 WV G3	-20 a +45 °C	60 kWh
929002410412	TForce Core HB 50W E40 865 WV G3	-20 °C a 45 °C	50 kWh
929003759212	TForce Core HB 4Klm 40W E27 865 WV	-20 a +45 °C	40 kWh

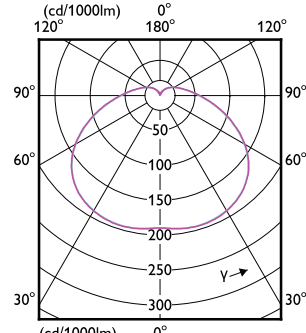
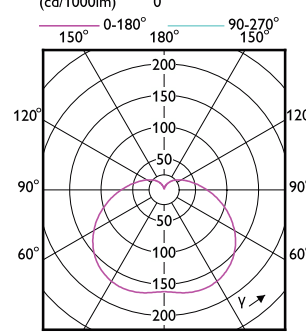
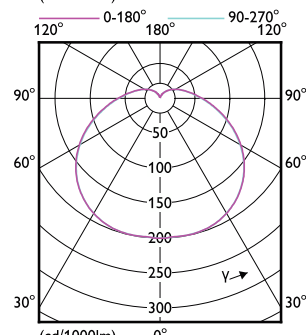
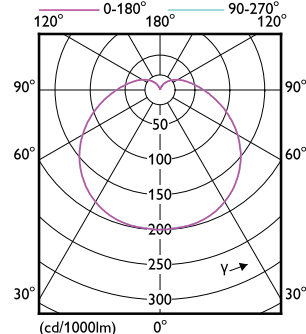
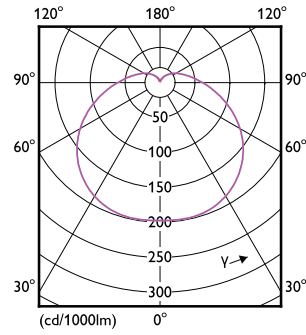
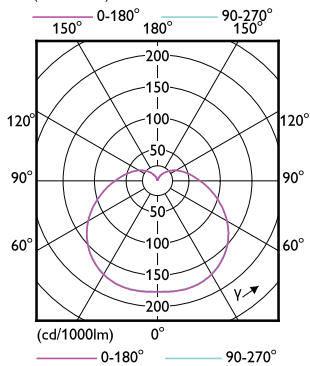
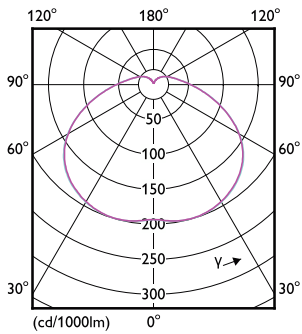

LED TrueForce Core industrial y comercial (Gran altura – HPI/SON/HPL)

