



# The best LED solution for High Intensity Discharge (HID) HPL lamp replacement

## MASTER - LED HID HPL

Philips Master LED HPL lamps offer an easy and short payback LED solution to replace High Intensity Discharge (HID) lamps. The products bring the energy efficiency and long lifetime benefits of LED to HID HPL replacement and provide instant saving and low initial investment. With the right lamp size and light distribution, you can easily retrofit Master LED HPL urban lamps and bypass the existing ballast while enhancing the lighting quality.

### Benefits

- Cost saving with short payback time
- Low initial investment
- Enhance lighting quality with easy adoption

### Features

- High Energy efficient lamps
- Long lifetime - 50,000 hrs
- Surge protection 4KV
- Pleasant white light with CRI 80
- Omnidirectional light around lamp
- Additional Energy saving by Direct Mains connection
- Right lamp size and lighting distribution for retrofit
- IP65 product (IP rated sockets required for outdoor application)

# MASTER - LED HID HPL

## Application

- Parking Garages
- Parks and Plazas
- Road and Street

## Warnings and Safety

- Please refer to the installation guide or consult a Philips Lighting representative for wiring diagram and instructions.

## Versions



LEDTForce MAS HPL ED75 E27

## Dimensional drawing

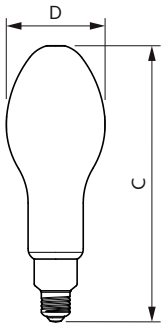
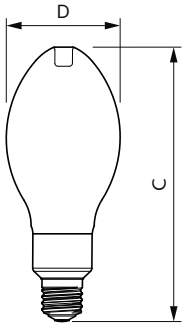

Product	D	C
MAS LED HPL M 2.8Klm 19W 830E27 FR G	71 mm	186 mm
MAS LED HPL M 3Klm 19W 840 E27 FR G	71 mm	186 mm

Product	D	C
MAS LED HPL M 3.8Klm 24W 830 E27 FR G	91 mm	249 mm
MAS LED HPL M 4Klm 24W 840 E27 FR G	91 mm	249 mm
MAS LED HPL M 5.6Klm 33.5W 830 E27 FR G	91 mm	249 mm
MAS LED HPL M 6Klm 33.5W 840 E27 FR G	91 mm	249 mm

# MASTER - LED HID HPL

## Dimensional drawing

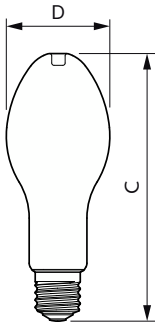

Product	D	C
MAS LED HPL M 5.6Klm 33.5W 830 E40 FR G	91 mm	238 mm
MAS LED HPL M 6Klm 33.5W 840 E40 FR G	91 mm	238 mm

General Information	
Switching Cycle	50,000
Nominal lifetime	50,000 hour(s)
Light Technical	
Beam Angle (Nom)	300 degree(s)
Color rendering index (CRI)	80
LLMF At End Of Nominal Lifetime (Nom)	70 %
Operating and Electrical	
Input Frequency	50 to 60 Hz
Line Frequency	50 to 60 Hz
Starting Time (Nom)	0.5 s
Controls and Dimming	
Dimmable	No
Mechanical and Housing	
Bulb Finish	Frosted
Bulb Shape	Oval
Approval and Application	
Ambient temperature range	-30 to +45 °C

## General Information

Order Code	Full Product Name	Cap-Base
929003530902	MAS LED HPL M 3.8Klm 24W 830 E27 FR G	E27
929003531002	MAS LED HPL M 4Klm 24W 840 E27 FR G	E27
929003531102	MAS LED HPL M 5.6Klm 33.5W 830 E27 FR G	E27
929003531202	MAS LED HPL M 6Klm 33.5W 840 E27 FR G	E27
929003531302	MAS LED HPL M 5.6Klm 33.5W 830 E40 FR G	E40
929003531402	MAS LED HPL M 6Klm 33.5W 840 E40 FR G	E40
929003530702	MAS LED HPL M 2.8Klm 19W 830E27 FR G	E27
929003530802	MAS LED HPL M 3Klm 19W 840 E27 FR G	E27

## Light Technical

Order Code	Full Product Name	Correlated Color		
		Temperature (Nom)	Color Code	Luminous Flux
929003530902	MAS LED HPL M 3.8Klm 24W 830 E27 FR G	3000 K	830	3,850 lm
929003531002	MAS LED HPL M 4Klm 24W 840 E27 FR G	4000 K	840	4,000 lm
929003531102	MAS LED HPL M 5.6Klm 33.5W 830 E27 FR G	3000 K	830	5,600 lm
929003531202	MAS LED HPL M 6Klm 33.5W 840 E27 FR G	4000 K	840	6,000 lm

Order Code	Full Product Name	Correlated Color		
		Temperature (Nom)	Color Code	Luminous Flux
929003531302	MAS LED HPL M 5.6Klm 33.5W 830 E40 FR G	3000 K	830	5,600 lm
929003531402	MAS LED HPL M 6Klm 33.5W 840 E40 FR G	4000 K	840	6,000 lm
929003530702	MAS LED HPL M 2.8Klm 19W 830E27 FR G	3000 K	830	2,850 lm
929003530802	MAS LED HPL M 3Klm 19W 840 E27 FR G	4000 K	840	3,100 lm

# MASTER - LED HID HPL

## Operating and Electrical

Order Code	Full Product Name	Power Consumption
929003530902	MAS LED HPL M 3.8Klm 24W 830 E27 FR G	24 W
929003531002	MAS LED HPL M 4Klm 24W 840 E27 FR G	24 W
929003531102	MAS LED HPL M 5.6Klm 33.5W 830 E27 FR G	33.5 W
929003531202	MAS LED HPL M 6Klm 33.5W 840 E27 FR G	33.5 W

Order Code	Full Product Name	Power Consumption
929003531302	MAS LED HPL M 5.6Klm 33.5W 830 E40 FR G	33.5 W
929003531402	MAS LED HPL M 6Klm 33.5W 840 E40 FR G	33.5 W
929003530702	MAS LED HPL M 2.8Klm 19W 830E27 FR G	19 W
929003530802	MAS LED HPL M 3Klm 19W 840 E27 FR G	19 W

## Temperature

Order Code	Full Product Name	T-Case Maximum (Nom)
929003530902	MAS LED HPL M 3.8Klm 24W 830 E27 FR G	55 °C
929003531002	MAS LED HPL M 4Klm 24W 840 E27 FR G	55 °C
929003531102	MAS LED HPL M 5.6Klm 33.5W 830 E27 FR G	65 °C
929003531202	MAS LED HPL M 6Klm 33.5W 840 E27 FR G	65 °C

Order Code	Full Product Name	T-Case Maximum (Nom)
929003531302	MAS LED HPL M 5.6Klm 33.5W 830 E40 FR G	65 °C
929003531402	MAS LED HPL M 6Klm 33.5W 840 E40 FR G	65 °C
929003530702	MAS LED HPL M 2.8Klm 19W 830E27 FR G	60 °C
929003530802	MAS LED HPL M 3Klm 19W 840 E27 FR G	60 °C

## Approval and Application

Order Code	Full Product Name	Energy Consumption kWh/1000 h
929003530902	MAS LED HPL M 3.8Klm 24W 830 E27 FR G	24 kWh
929003531002	MAS LED HPL M 4Klm 24W 840 E27 FR G	24 kWh
929003531102	MAS LED HPL M 5.6Klm 33.5W 830 E27 FR G	34 kWh
929003531202	MAS LED HPL M 6Klm 33.5W 840 E27 FR G	34 kWh
929003531302	MAS LED HPL M 5.6Klm 33.5W 830 E40 FR G	34 kWh
929003531402	MAS LED HPL M 6Klm 33.5W 840 E40 FR G	34 kWh
929003530702	MAS LED HPL M 2.8Klm 19W 830E27 FR G	19 kWh
929003530802	MAS LED HPL M 3Klm 19W 840 E27 FR G	19 kWh

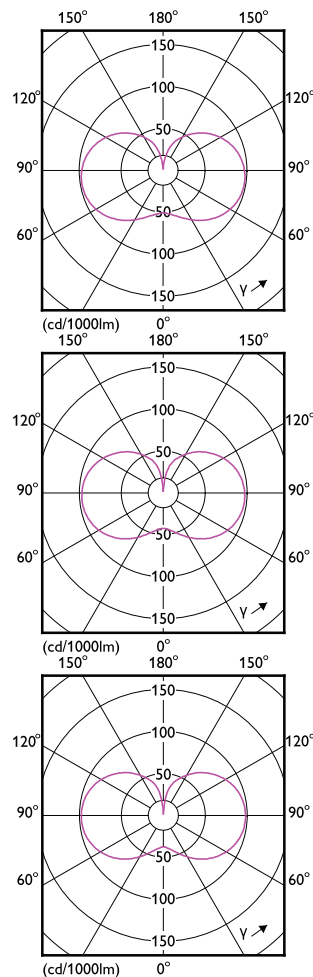
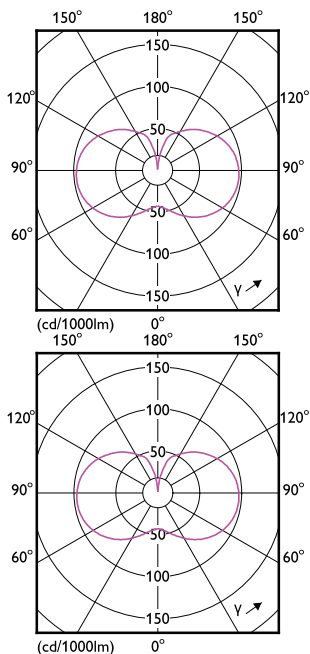

# MASTER - LED HID HPL

