



Luz focalizada de buen rendimiento para la renovación de focos halógenos MR16

MASTER LED spot LV

Al ofrecer un haz de acentuación intenso, MASTER LEDspot LV es una solución de renovación ideal para la iluminación focalizada. MASTER LEDspot LV está diseñada para el reemplazo de focos halógenos o incandescentes. Representa los colores naturales, permite una ambientación acogedora y cómoda para áreas residenciales, hostelería y resalta la belleza de la mercadería en venta. La nueva carcasa pequeña ofrece el ajuste perfecto con la mayoría de las luminarias en el mercado con un soporte MR16 GU 5.3. No solo utiliza la solución patentada de Philips para garantizar la mayor compatibilidad posible con los transformadores electrónicos halógenos de 12 V estándar, también ofrece una gran intensidad del haz de luz que equivale a los focos halógenos MR16. La función de regulación permite crear la atmósfera deseada y funciona con una amplia variedad de reguladores. Su SDCM alto garantiza una consistencia más estricta de color que se mantiene durante la vida útil del producto. MASTER LEDspot LV ofrece enormes ahorros de energía y minimiza el costo de mantenimiento sin sacrificar la calidad y la vida útil de la luz; asimismo, permite que los propietarios residenciales y comerciales recuperen la inversión en un corto período de tiempo.

Beneficios

- Haz de luz de gran intensidad para iluminación de acento en aplicaciones profesionales
- Se mantiene un brillo fuerte con el tiempo
- Representación más natural de los colores para una ambientación acogedora para la hostelería y mejor exhibición de mercadería en las aplicaciones de ventas

MASTER LED spot LV

Características

- Haz de luz de gran intensidad equivalente a los focos halógenos
- Mejor reproducción de color con valor IRC alto y una consistencia de color fuerte con el tiempo
- Apertura de haz con definición clara para una iluminación de acento
- Compatible con una amplia variedad de transformadores y reguladores de intensidad suave para productos regulables
- Gran mantenimiento lumínico con una vida útil prolongada de hasta 40 000 horas

Aplicaciones

- Hogar: sala de estar, habitación, salón
- Hostelería: habitaciones de huéspedes, pasillos, vestíbulos, zonas de recepción, restaurantes, bares, cafés
- Comercio: exposiciones, vitrinas, tiendas, vestidores, área de cajas

Plano de dimensiones

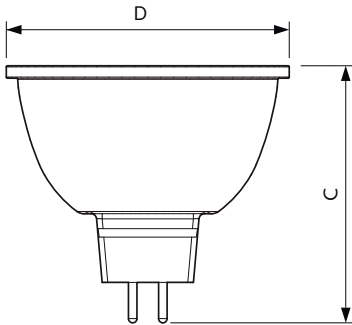

Product	D	C
7MR16/LED/827/F25/DIM 12V 10/1FB	50 mm	46.5 mm
7MR16/LED/827/F35/DIM 12V 10/1FB	50 mm	46.5 mm
7MR16/LED/830/F25/DIM 12V 10/1FB	50 mm	46.5 mm
7MR16/LED/830/F35/DIM 12V 10/1FB	50 mm	46.5 mm
8MR16/LED/827/F25/DIM 12V 10/1FB	50 mm	46.5 mm
8MR16/LED/827/F35/DIM 12V 10/1FB	50 mm	46.5 mm
8MR16/LED/830/F25/DIM 12V 10/1FB	50 mm	46.5 mm
8MR16/LED/830/F35/DIM 12V 10/1FB	50 mm	46.5 mm
8MR16/LED/840/F35/DIM 12V 10/1FB	50 mm	46.5 mm
MASTER LED 6.5-50W 927 MR16 36D Dim	50 mm	
MASTER LED 6.5-50W 940 MR16 36D Dim	50 mm	46.5 mm

MASTER LED spot LV

Información general	
Tapa-base	GU5.3
Ciclo del interruptor	50,000
Información técnica sobre la luz	
LLMF al final de la vida útil nominal (nominal)	70 %
Operación y aspectos eléctricos	
Frecuencia de entrada	- Hz
Frecuencia de línea	- Hz
Tiempo de inicio (nominal)	0.5 s
Controles y atenuación	
Regulable	Solo con reguladores de intensidad específicos
Mecánica y carcasa	
Forma del foco	MR16
Aprobación y aplicación	
Rango de temperatura ambiente	-20 a +45 °C

Información general

Order Code	Full Product Name	Vida útil nominal
929003072208	MASTER LED 6.5-50W 927 MR16 36D Dim	40,000 hora(s)
929003072408	MASTER LED 6.5-50W 940 MR16 36D Dim	40,000 hora(s)
929003072504	8MR16/LED/827/F25/DIM 12V 10/1FB	25,000 hora(s)
929003072604	8MR16/LED/830/F25/DIM 12V 10/1FB	25,000 hora(s)
929003072704	8MR16/LED/827/F35/DIM 12V 10/1FB	25,000 hora(s)
929003072804	8MR16/LED/830/F35/DIM 12V 10/1FB	25,000 hora(s)
929003072904	8MR16/LED/840/F35/DIM 12V 10/1FB	25,000 hora(s)
929003076204	7MR16/LED/827/F25/DIM 12V 10/1FB	25,000 hora(s)
929003076304	7MR16/LED/830/F25/DIM 12V 10/1FB	25,000 hora(s)
929003076404	7MR16/LED/827/F35/DIM 12V 10/1FB	25,000 hora(s)
929003076504	7MR16/LED/830/F35/DIM 12V 10/1FB	25,000 hora(s)

Información técnica sobre la luz (1/2)

Order Code	Full Product Name	Ángulo de haz (nominal)	Temperatura de color correlacionada (nominal)	Índice de producción de color (IRC)	Código de color
929003072208	MASTER LED 6.5-50W 927 MR16 36D Dim	36 °	2700 K	90	927
929003072408	MASTER LED 6.5-50W 940 MR16 36D Dim	36 °	4000 K	90	940
929003072504	8MR16/LED/8 27/F25/DIM 12V 10/1FB	25 °	2700 K	80	827
929003072604	8MR16/LED/8 30/F25/DIM 12V 10/1FB	25 °	3000 K	80	830
929003072704	8MR16/LED/8 27/F35/DIM 12V 10/1FB	35 °	2700 K	80	827
929003072804	8MR16/LED/8 30/F35/DIM 12V 10/1FB	35 °	3000 K	80	830

Order Code	Full Product Name	Ángulo de haz (nominal)	Temperatura de color correlacionada (nominal)	Índice de producción de color (IRC)	Código de color
929003072904	8MR16/LED/8 40/F35/DIM 12V 10/1FB	35 °	4000 K	80	840
929003076204	7MR16/LED/8 27/F25/DIM 12V 10/1FB	25 °	2700 K	80	827
929003076304	7MR16/LED/8 30/F25/DIM 12V 10/1FB	25 °	3000 K	80	830
929003076404	7MR16/LED/8 27/F35/DIM 12V 10/1FB	35 °	2700 K	80	827
929003076504	7MR16/LED/8 30/F35/DIM 12V 10/1FB	35 °	3000 K	80	830

Información técnica sobre la luz (2/2)

MASTER LED spot LV

Order Code	Full Product Name	Flujo luminoso	Intensidad lumínica (nominal)
929003072208	MASTER LED 6.5-50W 927 MR16 36D Dim	500 lm	1,400 cd
929003072408	MASTER LED 6.5-50W 940 MR16 36D Dim	530 lm	1,600 cd
929003072504	8MR16/LED/827/F25/DIM 12V 10/1FB	600 lm	3,100 cd
929003072604	8MR16/LED/830/F25/DIM 12V 10/1FB	620 lm	3,250 cd
929003072704	8MR16/LED/827/F35/DIM 12V 10/1FB	600 lm	1,700 cd
929003072804	8MR16/LED/830/F35/DIM 12V 10/1FB	620 lm	1,700 cd

Order Code	Full Product Name	Flujo luminoso	Intensidad lumínica (nominal)
929003072904	8MR16/LED/840/F35/DIM 12V 10/1FB	660 lm	1,800 cd
929003076204	7MR16/LED/827/F25/DIM 12V 10/1FB	515 lm	2,400 cd
929003076304	7MR16/LED/830/F25/DIM 12V 10/1FB	515 lm	2,500 cd
929003076404	7MR16/LED/827/F35/DIM 12V 10/1FB	515 lm	1,350 cd
929003076504	7MR16/LED/830/F35/DIM 12V 10/1FB	515 lm	1,350 cd

Operación y aspectos eléctricos

Order Code	Full Product Name	Consumo de energía	Equivalente en potencia en vatios
929003072208	MASTER LED 6.5-50W 927 MR16 36D Dim	6.5 W	50 W
929003072408	MASTER LED 6.5-50W 940 MR16 36D Dim	6.5 W	50 W
929003072504	8MR16/LED/827/F25/DIM 12V 10/1FB	8 W	75 W
929003072604	8MR16/LED/830/F25/DIM 12V 10/1FB	8 W	75 W
929003072704	8MR16/LED/827/F35/DIM 12V 10/1FB	8 W	75 W
929003072804	8MR16/LED/830/F35/DIM 12V 10/1FB	8 W	75 W

Order Code	Full Product Name	Consumo de energía	Equivalente en potencia en vatios
929003072904	8MR16/LED/840/F35/DIM 12V 10/1FB	8 W	75 W
929003076204	7MR16/LED/827/F25/DIM 12V 10/1FB	7 W	50 W
929003076304	7MR16/LED/830/F25/DIM 12V 10/1FB	7 W	50 W
929003076404	7MR16/LED/827/F35/DIM 12V 10/1FB	7 W	50 W
929003076504	7MR16/LED/830/F35/DIM 12V 10/1FB	7 W	50 W

Temperatura

Order Code	Full Product Name	T° estuche máxima (nominal)
929003072208	MASTER LED 6.5-50W 927 MR16 36D Dim	90 °C
929003072408	MASTER LED 6.5-50W 940 MR16 36D Dim	90 °C
929003072504	8MR16/LED/827/F25/DIM 12V 10/1FB	93 °C
929003072604	8MR16/LED/830/F25/DIM 12V 10/1FB	93 °C
929003072704	8MR16/LED/827/F35/DIM 12V 10/1FB	93 °C
929003072804	8MR16/LED/830/F35/DIM 12V 10/1FB	93 °C

Order Code	Full Product Name	T° estuche máxima (nominal)
929003072904	8MR16/LED/840/F35/DIM 12V 10/1FB	93 °C
929003076204	7MR16/LED/827/F25/DIM 12V 10/1FB	90 °C
929003076304	7MR16/LED/830/F25/DIM 12V 10/1FB	90 °C
929003076404	7MR16/LED/827/F35/DIM 12V 10/1FB	90 °C
929003076504	7MR16/LED/830/F35/DIM 12V 10/1FB	90 °C

Mecánica y carcasa

Order Code	Full Product Name	Acabado de la luz
929003072208	MASTER LED 6.5-50W 927 MR16 36D Dim	-
929003072408	MASTER LED 6.5-50W 940 MR16 36D Dim	-
929003072504	8MR16/LED/827/F25/DIM 12V 10/1FB	Transparente
929003072604	8MR16/LED/830/F25/DIM 12V 10/1FB	Transparente
929003072704	8MR16/LED/827/F35/DIM 12V 10/1FB	Transparente

Order Code	Full Product Name	Acabado de la luz
929003072804	8MR16/LED/830/F35/DIM 12V 10/1FB	Transparente
929003072904	8MR16/LED/840/F35/DIM 12V 10/1FB	Transparente
929003076204	7MR16/LED/827/F25/DIM 12V 10/1FB	Transparente
929003076304	7MR16/LED/830/F25/DIM 12V 10/1FB	Transparente
929003076404	7MR16/LED/827/F35/DIM 12V 10/1FB	Transparente

MASTER LED spot LV

Order Code	Full Product Name	Acabado de la luz
929003076504	7MR16/LED/830/F35/DIM 12V 10/1FB	Transparente

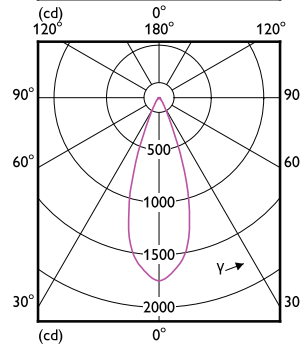
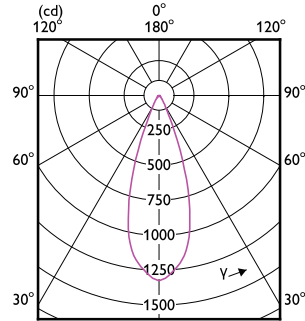
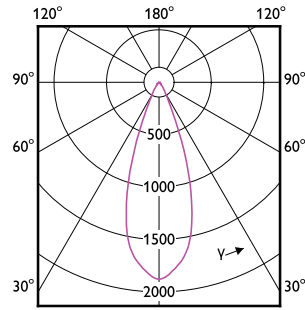
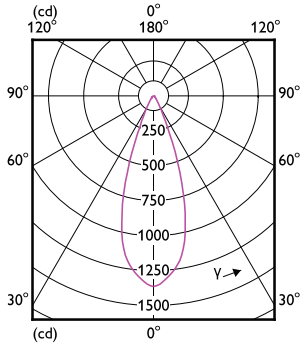
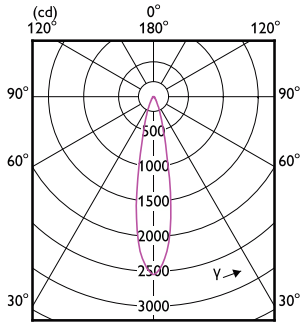
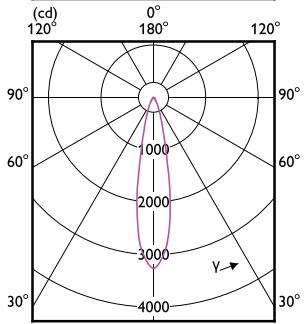
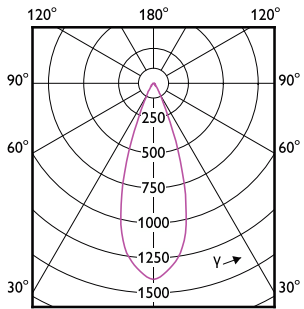

Accent Diagrams

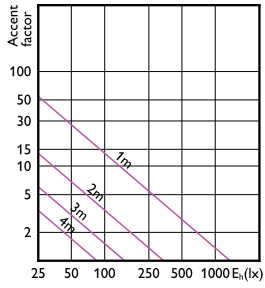

Accent Diagram - 7MR16/LED/827/F35/DIM 12V 10/1FB

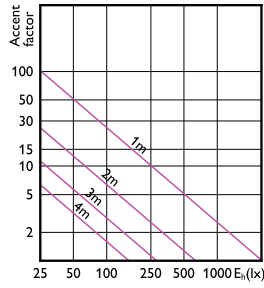

Accent Diagram - 7MR16/LED/827/F25/DIM 12V 10/1FB

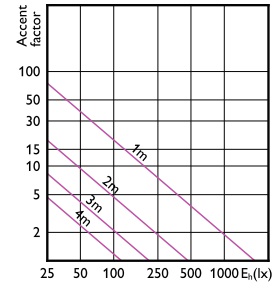

Accent Diagram - 8MR16/LED/840/F35/DIM 12V 10/1FB

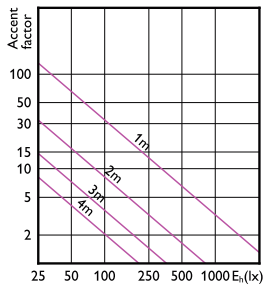

Accent Diagram - 8MR16/LED/827/F25/DIM 12V 10/1FB

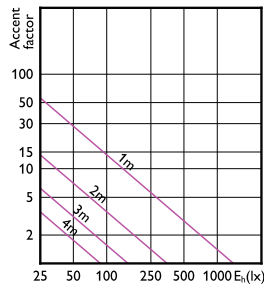

Accent Diagram - MASTER LED 6.5-50W 940 MR16 36D Dim

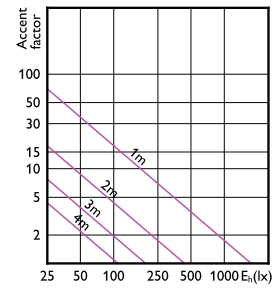

Accent Diagram - 8MR16/LED/830/F35/DIM 12V 10/1FB

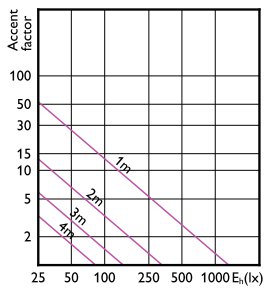

Accent Diagram - MASTER LED 6.5-50W 927 MR16 36D Dim

Beam Diagrams

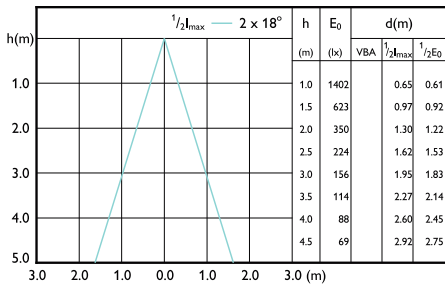

Beam diagram - MASTER LED 6.5-50W 940 MR16 36D Dim

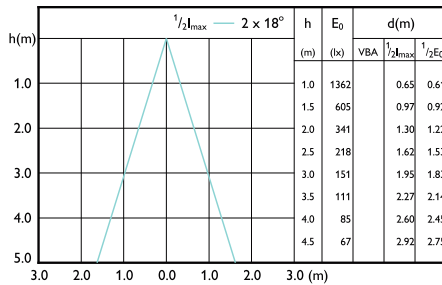

Beam diagram - 7MR16/LED/827/F35/DIM 12V 10/1FB

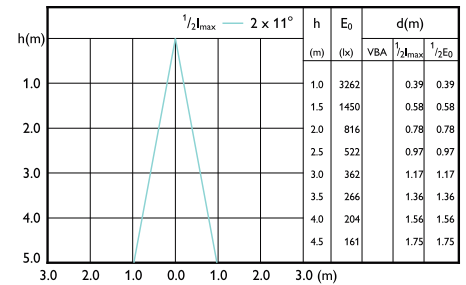

Beam diagram - 8MR16/LED/827/F25/DIM 12V 10/1FB

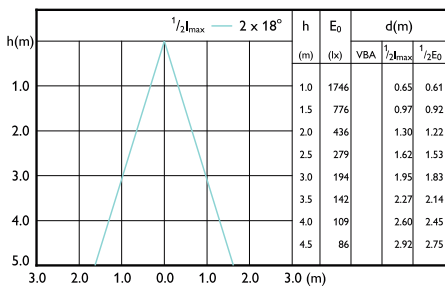

Beam diagram - 8MR16/LED/830/F35/DIM 12V 10/1FB

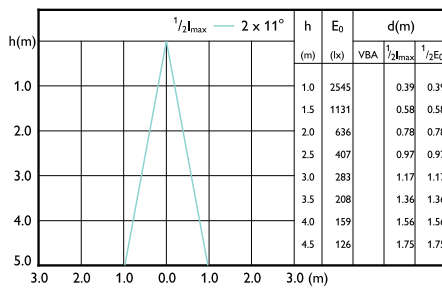

Beam diagram - 7MR16/LED/827/F25/DIM 12V 10/1FB

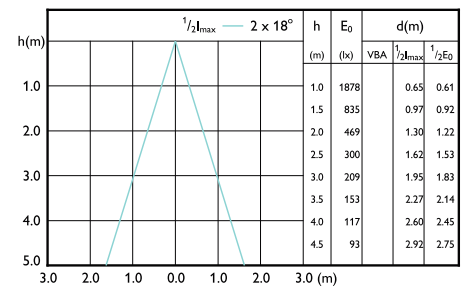

Beam diagram - 8MR16/LED/840/F35/DIM 12V 10/1FB

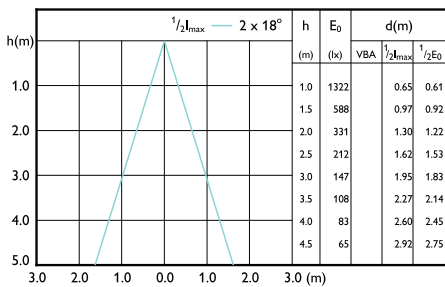

Beam diagram - MASTER LED 6.5-50W 927 MR16 36D Dim

MASTER LED spot LV

