



# Strong performance spot light for retrofit MR16 halogen spots

## MASTER LED spot LV

Delivering intense accent beam, MASTER LEDspot LV is an ideal retrofit solution for spot lighting. MASTER LEDspot LV is designed to replace halogen or incandescent spots. It realizes natural colors, enables cozy and comfortable ambience for residential, hospitality and emphasizes the beauty of merchandise in retail. New smaller housing provides perfect fitting with majority of luminaires in a market with a MR16 GU 5.3 holder. It not only employs Philips' patented solution to guarantee the broadest possible compatibility with standard 12V halogen electronic transformers, it also delivers high beam intensity which is equivalent to halogen MR16 spots. The dimming function enables to create the desired atmosphere and it works with broad selection of dimmers. Its high SDCM ensure stricter color consistency, that is maintained over product life. MASTER LEDspot LV delivers huge energy savings and minimizes maintenance cost without any compromise on light quality and lifetime, enabling residential and business owners to achieve a return on their investment within short period time.

### Benefits

- High intensity of beam for accent lighting in professional applications
- Strong brightness maintained over time
- More natural colors realised for cozy ambience for hospitality and better merchandise display in retail application

# MASTER LED spot LV

## Features

- High intensity of beam equivalent to halogen spots
- Better color realisation with high CRI value, and strong color consistency over time
- Clearly defined beam spread for accent lighting
- Compatible with an extensive range of transformers and smooth dimming for dimmable products
- High lumen maintenance with long lifetime up to 40,000 hours

## Application

- Home: Living room, bed room, hall way
- Hospitality: Hotel guest room, corridors, lobby, reception area, restaurant, bars, cafes
- Retail: Exhibitions, display cabinets, shops, dressing room, check out area

## Versions



7-50W GU5-3 MR16



50W GU5-3 MR16



LEDspots GMGC 1 MR16 GU5,3 1

## Dimensional drawing

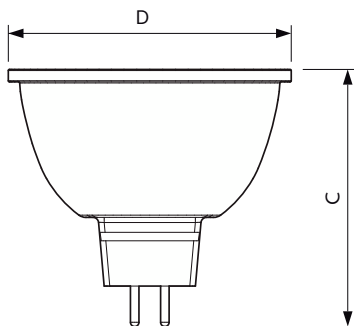

Product	D	C
MASTER LED 6.5-50W 927 MR16 10D Dim	50 mm	46.5 mm
MASTER LED 6.5-50W 927 MR16 24D Dim	50 mm	
MASTER LED 6.5-50W 927 MR16 36D Dim	50 mm	
MASTER LED 6.5-50W 927 MR16 60D Dim	50 mm	46.5 mm
MASTER LED 6.5-50W 930 MR16 10D Dim	50 mm	46.5 mm
MASTER LED 6.5-50W 930 MR16 24D Dim	50 mm	46.5 mm
MASTER LED 6.5-50W 930 MR16 24D ND	50.5 mm	46.5 mm
MASTER LED 6.5-50W 930 MR16 36D Dim	50 mm	46.5 mm
MASTER LED 6.5-50W 930 MR16 36D ND	50.5 mm	46.5 mm
MASTER LED 6.5-50W 930 MR16 60D Dim	50 mm	46.5 mm
MASTER LED 6.5-50W 940 MR16 24D Dim	50 mm	46.5 mm
MASTER LED 6.5-50W 940 MR16 36D Dim	50 mm	46.5 mm
MASTER LED 6.5-50W 940 MR16 60D Dim	50 mm	46.5 mm
MASTER LED 7.5-50W+ 827 MR16 36D Dim	50 mm	46.5 mm
MASTER LED 7.5-50W+ 830 MR16 36D Dim	50 mm	46.5 mm

# MASTER LED spot LV

General Information	
Cap-Base	GU5.3
Switching Cycle	50,000
Nominal lifetime	40,000 hour(s)
Light Technical	
LLMF At End Of Nominal Lifetime (Nom)	70 %
Operating and Electrical	
Input Frequency	- Hz
Line Frequency	- Hz
Starting Time (Nom)	0.5 s
Wattage Equivalent	50 W
Mechanical and Housing	
Bulb Shape	MR16

## Light Technical (1/2)

Order Code	Full Product Name	Beam Angle (Nom)	Correlated Color Temperature (Nom)	Color rendering index (CRI)	Color Code
929001882008	MASTER LED 6.5-50W 930 MR16 24D ND	24 degree(s)	3000 K	90	930
929003071908	MASTER LED 6.5-50W 927 MR16 24D Dim	24 degree(s)	2700 K	90	927
929003072008	MASTER LED 6.5-50W 930 MR16 24D Dim	24 degree(s)	3000 K	90	930
929003072108	MASTER LED 6.5-50W 940 MR16 24D Dim	24 degree(s)	4000 K	90	940
929003072208	MASTER LED 6.5-50W 927 MR16 36D Dim	36 degree(s)	2700 K	90	927
929003072308	MASTER LED 6.5-50W 930 MR16 36D Dim	36 degree(s)	3000 K	90	930
929003072408	MASTER LED 6.5-50W 940 MR16 36D Dim	36 degree(s)	4000 K	90	940
929003072708	MASTER LED 7.5-50W+ 827 MR16 36D Dim	36 degree(s)	2700 K	80	827
929003072808	MASTER LED 7.5-50W+ 830 MR16 36D Dim	36 degree(s)	3000 K	80	830
929003071608	MASTER LED 6.5-50W 927 MR16 10D Dim	10 degree(s)	2700 K	90	927
929003071708	MASTER LED 6.5-50W 930 MR16 10D Dim	10 degree(s)	3000 K	90	930
929001882308	MASTER LED 6.5-50W 930 MR16 36D ND	36 degree(s)	3000 K	90	930
929003075908	MASTER LED 6.5-50W 927 MR16 60D Dim	60 degree(s)	2700 K	90	927
929003076008	MASTER LED 6.5-50W 930 MR16 60D Dim	60 degree(s)	3000 K	90	930
929003076108	MASTER LED 6.5-50W 940 MR16 60D Dim	60 degree(s)	4000 K	90	940

## Light Technical (2/2)

Order Code	Full Product Name	Luminous Flux	Luminous Intensity (Nom)	Order Code	Full Product Name	Luminous Flux	Luminous Intensity (Nom)
929001882008	MASTER LED 6.5-50W 930 MR16 24D ND	470 lm	2,300 cd	929003072408	MASTER LED 6.5-50W 940 MR16 36D Dim	530 lm	1,600 cd
929003071908	MASTER LED 6.5-50W 927 MR16 24D Dim	500 lm	2,800 cd	929003072708	MASTER LED 7.5-50W+ 827 MR16 36D Dim	660 lm	1,700 cd
929003072008	MASTER LED 6.5-50W 930 MR16 24D Dim	500 lm	2,800 cd	929003072808	MASTER LED 7.5-50W+ 830 MR16 36D Dim	660 lm	1,700 cd
929003072108	MASTER LED 6.5-50W 940 MR16 24D Dim	530 lm	3,400 cd	929003071608	MASTER LED 6.5-50W 927 MR16 10D Dim	500 lm	5,300 cd
929003072208	MASTER LED 6.5-50W 927 MR16 36D Dim	500 lm	1,400 cd	929003071708	MASTER LED 6.5-50W 930 MR16 10D Dim	500 lm	5,300 cd
929003072308	MASTER LED 6.5-50W 930 MR16 36D Dim	500 lm	1,600 cd	929001882308	MASTER LED 6.5-50W 930 MR16 36D ND	470 lm	1,400 cd

## MASTER LED spot LV

Order Code	Full Product Name	Luminous	
		Luminous Flux	Intensity (Nom)
929003075908	MASTER LED 6.5-50W 927 MR16 60D Dim	500 lm	500 cd
929003076008	MASTER LED 6.5-50W 930 MR16 60D Dim	500 lm	500 cd

Order Code	Full Product Name	Luminous	
		Luminous Flux	Intensity (Nom)
929003076108	MASTER LED 6.5-50W 940 MR16 60D Dim	530 lm	550 cd

### Operating and Electrical

Order Code	Full Product Name	Power Consumption
929001882008	MASTER LED 6.5-50W 930 MR16 24D ND	6.5 W
929003071908	MASTER LED 6.5-50W 927 MR16 24D Dim	6.5 W
929003072008	MASTER LED 6.5-50W 930 MR16 24D Dim	6.5 W
929003072108	MASTER LED 6.5-50W 940 MR16 24D Dim	6.5 W
929003072208	MASTER LED 6.5-50W 927 MR16 36D Dim	6.5 W
929003072308	MASTER LED 6.5-50W 930 MR16 36D Dim	6.5 W
929003072408	MASTER LED 6.5-50W 940 MR16 36D Dim	6.5 W
929003072708	MASTER LED 7.5-50W+ 827 MR16 36D Dim	7.5 W

Order Code	Full Product Name	Power Consumption
929003072808	MASTER LED 7.5-50W+ 830 MR16 36D Dim	7.5 W
929003071608	MASTER LED 6.5-50W 927 MR16 10D Dim	6.5 W
929003071708	MASTER LED 6.5-50W 930 MR16 10D Dim	6.5 W
929001882308	MASTER LED 6.5-50W 930 MR16 36D ND	6.5 W
929003075908	MASTER LED 6.5-50W 927 MR16 60D Dim	6.5 W
929003076008	MASTER LED 6.5-50W 930 MR16 60D Dim	6.5 W
929003076108	MASTER LED 6.5-50W 940 MR16 60D Dim	6.5 W

### Temperature

Order Code	Full Product Name	T-Case Maximum (Nom)
929001882008	MASTER LED 6.5-50W 930 MR16 24D ND	90 °C
929003071908	MASTER LED 6.5-50W 927 MR16 24D Dim	90 °C
929003072008	MASTER LED 6.5-50W 930 MR16 24D Dim	90 °C
929003072108	MASTER LED 6.5-50W 940 MR16 24D Dim	90 °C
929003072208	MASTER LED 6.5-50W 927 MR16 36D Dim	90 °C
929003072308	MASTER LED 6.5-50W 930 MR16 36D Dim	90 °C
929003072408	MASTER LED 6.5-50W 940 MR16 36D Dim	90 °C
929003072708	MASTER LED 7.5-50W+ 827 MR16 36D Dim	93 °C

Order Code	Full Product Name	T-Case Maximum (Nom)
929003072808	MASTER LED 7.5-50W+ 830 MR16 36D Dim	93 °C
929003071608	MASTER LED 6.5-50W 927 MR16 10D Dim	90 °C
929003071708	MASTER LED 6.5-50W 930 MR16 10D Dim	90 °C
929001882308	MASTER LED 6.5-50W 930 MR16 36D ND	90 °C
929003075908	MASTER LED 6.5-50W 927 MR16 60D Dim	90 °C
929003076008	MASTER LED 6.5-50W 930 MR16 60D Dim	90 °C
929003076108	MASTER LED 6.5-50W 940 MR16 60D Dim	90 °C

### Controls and Dimming

Order Code	Full Product Name	Dimmable
929001882008	MASTER LED 6.5-50W 930 MR16 24D ND	No
929003071908	MASTER LED 6.5-50W 927 MR16 24D Dim	Only with specific dimmers
929003072008	MASTER LED 6.5-50W 930 MR16 24D Dim	Only with specific dimmers
929003072108	MASTER LED 6.5-50W 940 MR16 24D Dim	Only with specific dimmers
929003072208	MASTER LED 6.5-50W 927 MR16 36D Dim	Only with specific dimmers
929003072308	MASTER LED 6.5-50W 930 MR16 36D Dim	Only with specific dimmers
929003072408	MASTER LED 6.5-50W 940 MR16 36D Dim	Only with specific dimmers
929003072708	MASTER LED 7.5-50W+ 827 MR16 36D Dim	Only with specific dimmers
929003072808	MASTER LED 7.5-50W+ 830 MR16 36D Dim	Only with specific dimmers

Order Code	Full Product Name	Dimmable
929003071608	MASTER LED 6.5-50W 927 MR16 10D Dim	Only with specific dimmers
929003071708	MASTER LED 6.5-50W 930 MR16 10D Dim	Only with specific dimmers
929001882308	MASTER LED 6.5-50W 930 MR16 36D ND	No
929003075908	MASTER LED 6.5-50W 927 MR16 60D Dim	Only with specific dimmers
929003076008	MASTER LED 6.5-50W 930 MR16 60D Dim	Only with specific dimmers
929003076108	MASTER LED 6.5-50W 940 MR16 60D Dim	Only with specific dimmers

### Mechanical and Housing

Order Code	Full Product Name	Bulb Finish
929001882008	MASTER LED 6.5-50W 930 MR16 24D ND	Clear
929003071908	MASTER LED 6.5-50W 927 MR16 24D Dim	-
929003072008	MASTER LED 6.5-50W 930 MR16 24D Dim	-

Order Code	Full Product Name	Bulb Finish
929003072108	MASTER LED 6.5-50W 940 MR16 24D Dim	-
929003072208	MASTER LED 6.5-50W 927 MR16 36D Dim	-
929003072308	MASTER LED 6.5-50W 930 MR16 36D Dim	-

# MASTER LED spot LV

Order Code	Full Product Name	Bulb Finish
929003072408	MASTER LED 6.5-50W 940 MR16 36D Dim	-
929003072708	MASTER LED 7.5-50W+ 827 MR16 36D Dim	-
929003072808	MASTER LED 7.5-50W+ 830 MR16 36D Dim	-
929003071608	MASTER LED 6.5-50W 927 MR16 10D Dim	-
929003071708	MASTER LED 6.5-50W 930 MR16 10D Dim	-

Order Code	Full Product Name	Bulb Finish
929001882308	MASTER LED 6.5-50W 930 MR16 36D ND	Clear
929003075908	MASTER LED 6.5-50W 927 MR16 60D Dim	-
929003076008	MASTER LED 6.5-50W 930 MR16 60D Dim	-
929003076108	MASTER LED 6.5-50W 940 MR16 60D Dim	-

## Approval and Application

Order Code	Full Product Name	Ambient temperature range
929001882008	MASTER LED 6.5-50W 930 MR16 24D ND	-20 °C to 45 °C
929003071908	MASTER LED 6.5-50W 927 MR16 24D Dim	-20 to +45 °C
929003072008	MASTER LED 6.5-50W 930 MR16 24D Dim	-20 to +45 °C
929003072108	MASTER LED 6.5-50W 940 MR16 24D Dim	-20 to +45 °C
929003072208	MASTER LED 6.5-50W 927 MR16 36D Dim	-20 to +45 °C
929003072308	MASTER LED 6.5-50W 930 MR16 36D Dim	-20 to +45 °C
929003072408	MASTER LED 6.5-50W 940 MR16 36D Dim	-20 to +45 °C
929003072708	MASTER LED 7.5-50W+ 827 MR16 36D Dim	-20 to +45 °C
929003072808	MASTER LED 7.5-50W+ 830 MR16 36D Dim	-20 to +45 °C
929003071608	MASTER LED 6.5-50W 927 MR16 10D Dim	-20 to +45 °C
929003071708	MASTER LED 6.5-50W 930 MR16 10D Dim	-20 to +45 °C
929001882308	MASTER LED 6.5-50W 930 MR16 36D ND	-20 °C to 45 °C
929003075908	MASTER LED 6.5-50W 927 MR16 60D Dim	-20 to +45 °C
929003076008	MASTER LED 6.5-50W 930 MR16 60D Dim	-20 to +45 °C
929003076108	MASTER LED 6.5-50W 940 MR16 60D Dim	-20 to +45 °C

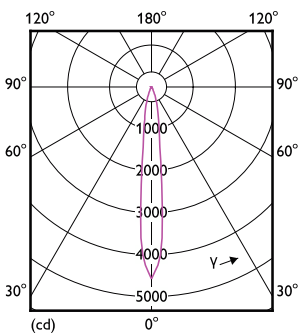
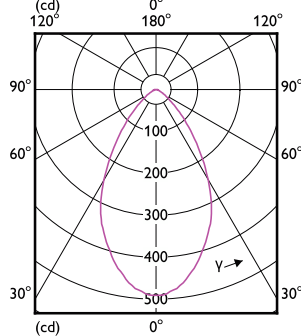
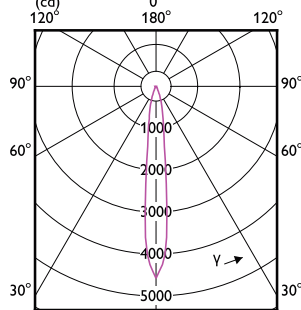
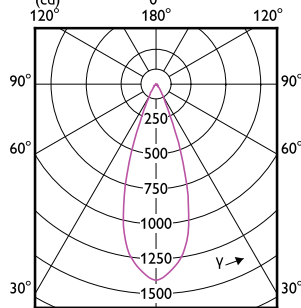
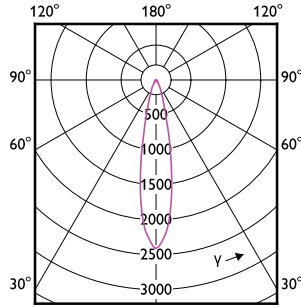

# MASTER LED spot LV

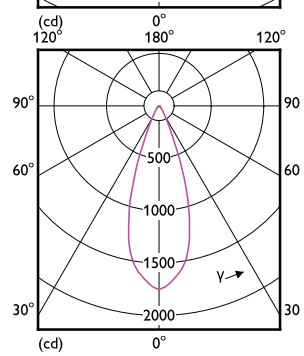
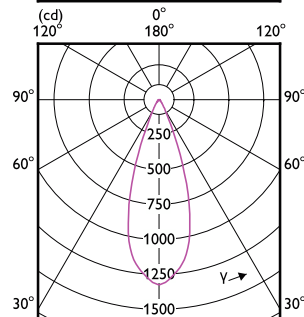
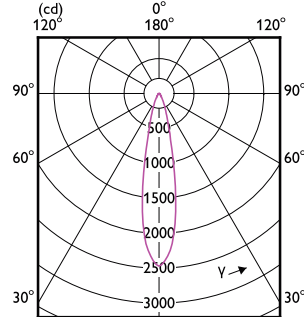
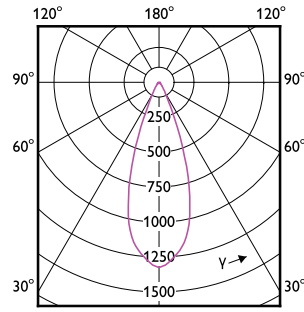
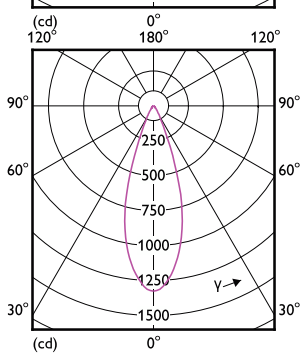
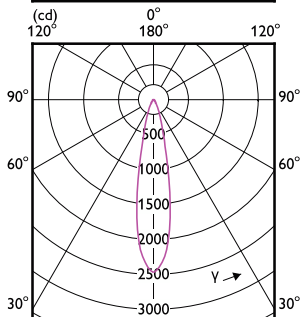
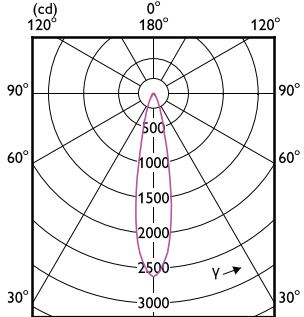
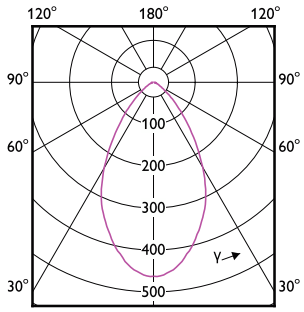

## Accent Diagrams

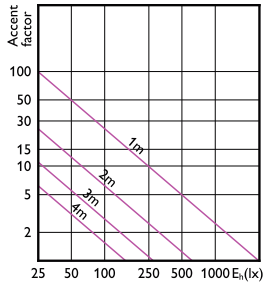

Accent Diagram - MASTER LED 6.5-50W 930  
MR16 24D Dim

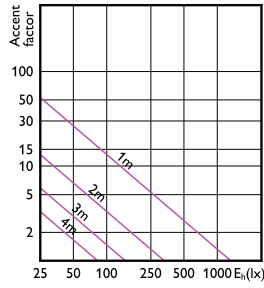

Accent Diagram - MASTER LED 6.5-50W 930  
MR16 36D Dim

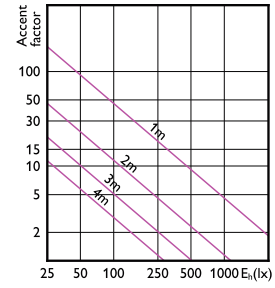

Accent Diagram - MASTER LED 6.5-50W 930  
MR16 10D Dim

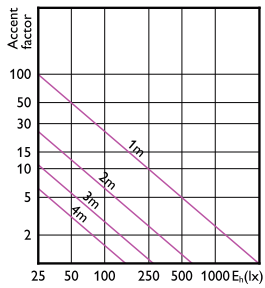

Accent Diagram - MASTER LED 6.5-50W 927  
MR16 24D Dim

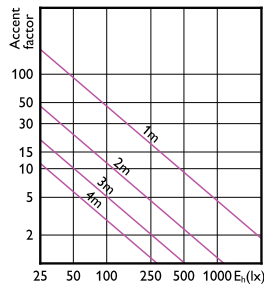

Accent Diagram - MASTER LED 6.5-50W 927  
MR16 10D Dim

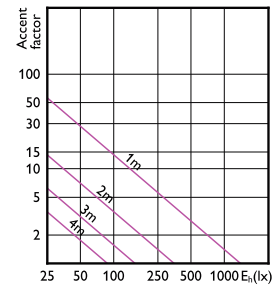

Accent Diagram - MASTER LED 6.5-50W 940  
MR16 36D Dim

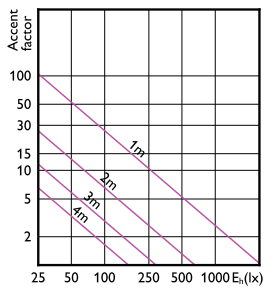

Accent Diagram - MASTER LED 6.5-50W 940  
MR16 24D Dim

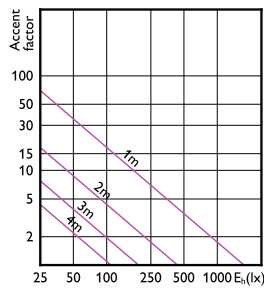

Accent Diagram - MASTER LED 7.5-50W+ 827  
MR16 36D Dim

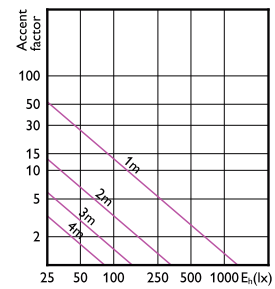

Accent Diagram - MASTER LED 6.5-50W 927  
MR16 36D Dim

# MASTER LED spot LV

## Accent Diagrams

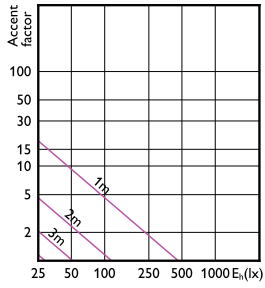

Accent Diagram - MASTER LED 6.5-50W 927  
MR16 60D Dim

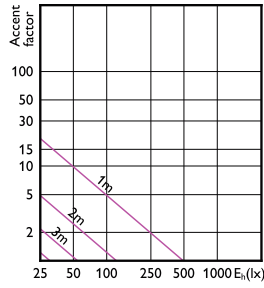

Accent Diagram - MASTER LED 6.5-50W 940  
MR16 60D Dim

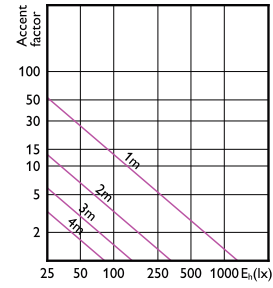

Accent Diagram - MASTER LED 6.5-50W 930  
MR16 36D ND

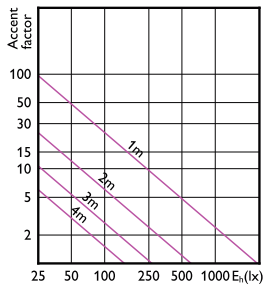

Accent Diagram - MASTER LED 6.5-50W 930  
MR16 24D ND

## Beam Diagrams

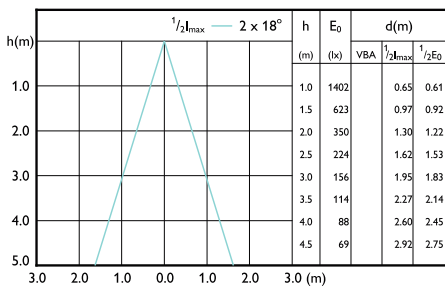

Beam diagram - MASTER LED 6.5-50W 940  
MR16 36D Dim

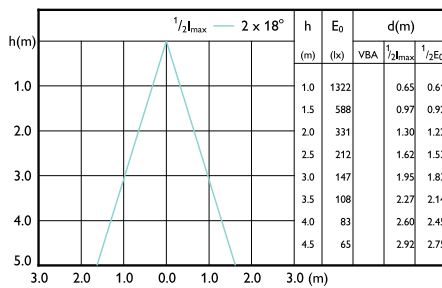

Beam diagram - MASTER LED 6.5-50W 930  
MR16 36D Dim

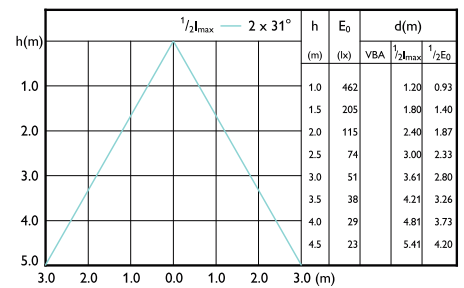

Beam diagram - MASTER LED 6.5-50W 927  
MR16 60D Dim

## Beam Diagrams

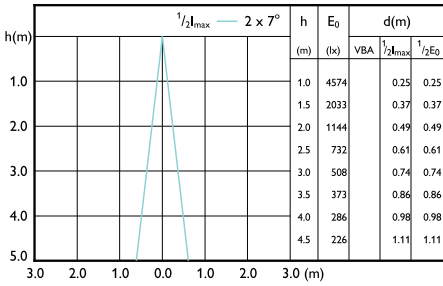

Beam diagram - MASTER LED 6.5-50W 927 MR16 10D Dim

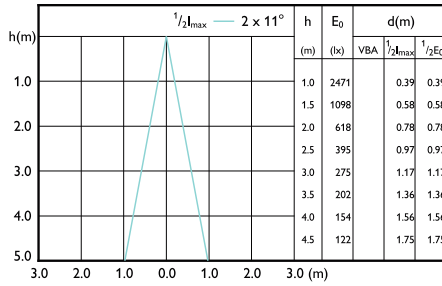

Beam diagram - MASTER LED 6.5-50W 927 MR16 24D Dim

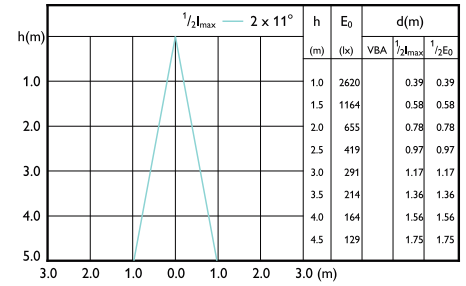

Beam diagram - MASTER LED 6.5-50W 940 MR16 24D Dim

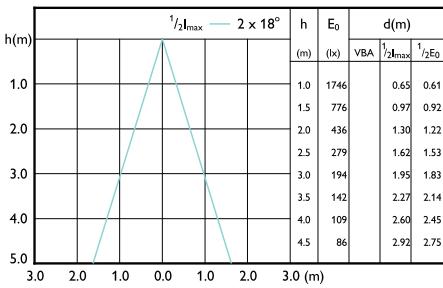

Beam diagram - MASTER LED 7.5-50W+ 827 MR16 36D Dim

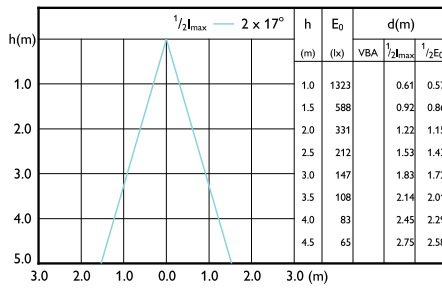

Beam diagram - MASTER LED 6.5-50W 930 MR16 36D ND

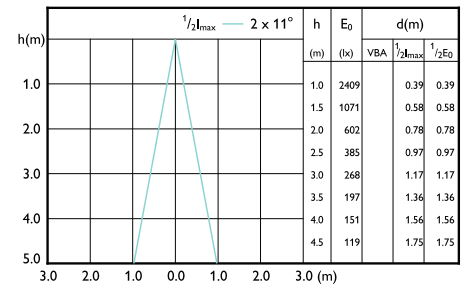

Beam diagram - MASTER LED 6.5-50W 930 MR16 24D ND

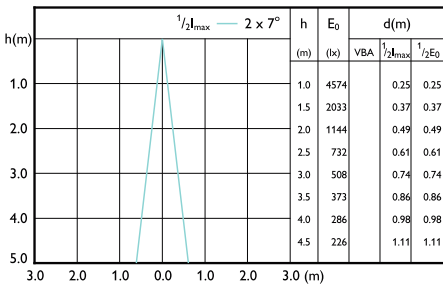

Beam diagram - MASTER LED 6.5-50W 930 MR16 10D Dim

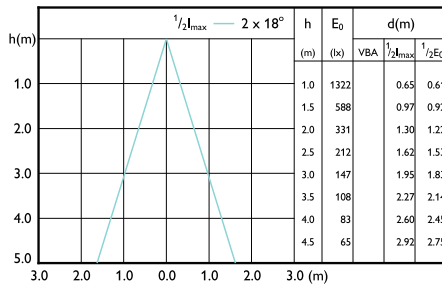

Beam diagram - MASTER LED 6.5-50W 927 MR16 36D Dim

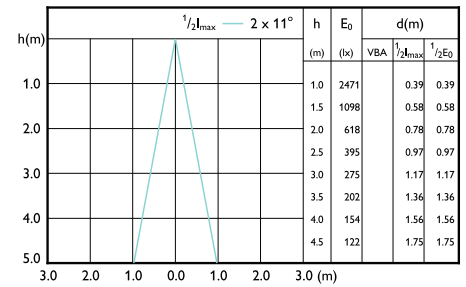

Beam diagram - MASTER LED 6.5-50W 930 MR16 24D Dim

# MASTER LED spot LV

## Beam Diagrams

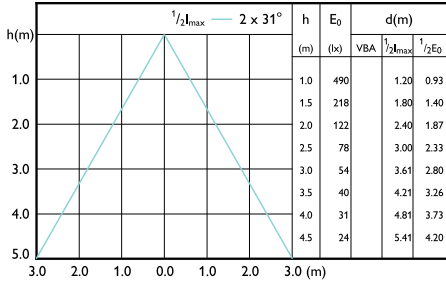

Beam diagram - MASTER LED 6.5-50W 940  
MR16 60D Dim

