



# Strong performance spot light for retrofit MR16 halogen spots

## MASTER LED spot LV

Delivering intense accent beam, MASTER LEDspot LV is an ideal retrofit solution for spot lighting. MASTER LEDspot LV is designed to replace halogen or incandescent spots. It realizes natural colors, enables cozy and comfortable ambience for residential, hospitality and emphasizes the beauty of merchandise in retail. New smaller housing provides perfect fitting with majority of luminaires in a market with a MR16 GU 5.3 holder. It not only employs Philips' patented solution to guarantee the broadest possible compatibility with standard 12V halogen electronic transformers, it also delivers high beam intensity which is equivalent to halogen MR16 spots. The dimming function enables to create the desired atmosphere and it works with broad selection of dimmers. Its high SDCM ensure stricter color consistency, that is maintained over product life. MASTER LEDspot LV delivers huge energy savings and minimizes maintenance cost without any compromise on light quality and lifetime, enabling residential and business owners to achieve a return on their investment within short period time.

### Benefits

- High intensity of beam for accent lighting in professional applications
- Strong brightness maintained over time
- More natural colors realised for cozy ambience for hospitality and better merchandise display in retail application

# MASTER LED spot LV

## Features

- High intensity of beam equivalent to halogen spots
- Better color realisation with high CRI value, and strong color consistency over time
- Clearly defined beam spread for accent lighting
- Compatible with an extensive range of transformers and smooth dimming for dimmable products
- High lumen maintenance with long lifetime up to 40,000 hours

## Application

- Home: Living room, bed room, hall way
- Hospitality: Hotel guest room, corridors, lobby, reception area, restaurant, bars, cafes
- Retail: Exhibitions, display cabinets, shops, dressing room, check out area

## Versions



LEDspot MAS 50W GU5.3 MR16 827 24D

## Dimensional drawing

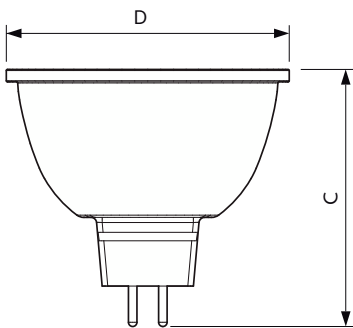

Product	D	C
MASTER LED 6.5-50W 927 MR16 36D Dim	50 mm	
MASTER LED 6.5-50W 940 MR16 36D Dim	50 mm	46.5 mm
MASTER LED 8-50W+ 827 MR16 36D Dim	50 mm	46.5 mm

# MASTER LED spot LV

## General Information

Cap-Base	GU5.3
Switching Cycle	50,000
Nominal lifetime	40,000 hour(s)

## Light Technical

Beam Angle (Nom)	36 degree(s)
LLMF At End Of Nominal Lifetime (Nom)	70 %

## Operating and Electrical

Input Frequency	- Hz
Line Frequency	- Hz
Starting Time (Nom)	0.5 s
Wattage Equivalent	50 W

## Controls and Dimming

Dimmable	Only with specific dimmers
----------	----------------------------

## Mechanical and Housing

Bulb Shape	MR16
------------	------

## Approval and Application

Ambient temperature range	-20 to +45 °C
---------------------------	---------------

## Light Technical (1/2)

Order Code	Full Product Name	Correlated Color Temperature (Nom)	Color		
			rendering index (CRI)	Code	Luminous Flux
929003072208	MASTER LED 6.5-50W 927 MR16 36D Dim	2700 K	90	927	500 lm
929003072408	MASTER LED 6.5-50W 940 MR16 36D Dim	4000 K	90	940	530 lm
929003072717	MASTER LED 8-50W+ 827 MR16 36D Dim	2700 K	80	827	660 lm

## Light Technical (2/2)

Order Code	Full Product Name	Luminous Intensity (Nom)
929003072208	MASTER LED 6.5-50W 927 MR16 36D Dim	1,400 cd
929003072408	MASTER LED 6.5-50W 940 MR16 36D Dim	1,600 cd

Order Code	Full Product Name	Luminous Intensity (Nom)
929003072717	MASTER LED 8-50W+ 827 MR16 36D Dim	1,700 cd

## Operating and Electrical

Order Code	Full Product Name	Power Consumption
929003072208	MASTER LED 6.5-50W 927 MR16 36D Dim	6.5 W
929003072408	MASTER LED 6.5-50W 940 MR16 36D Dim	6.5 W

Order Code	Full Product Name	Power Consumption
929003072717	MASTER LED 8-50W+ 827 MR16 36D Dim	8 W

## Temperature

Order Code	Full Product Name	T-Case Maximum (Nom)
929003072208	MASTER LED 6.5-50W 927 MR16 36D Dim	90 °C
929003072408	MASTER LED 6.5-50W 940 MR16 36D Dim	90 °C
929003072717	MASTER LED 8-50W+ 827 MR16 36D Dim	93 °C

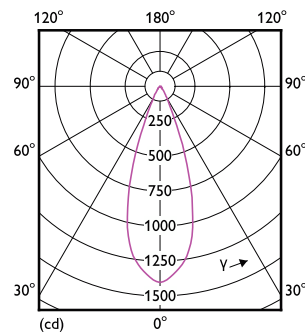

# MASTER LED spot LV

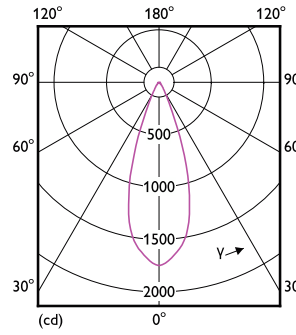
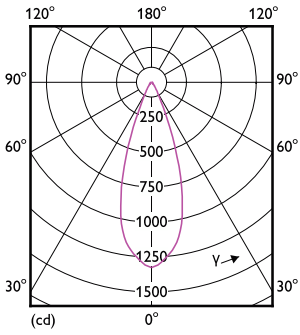

## Accent Diagrams

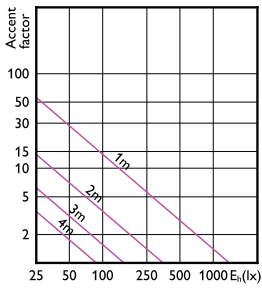

Accent Diagram - MASTER LED 6.5-50W 940 MR16 36D Dim

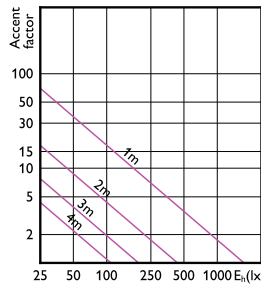

Accent Diagram - MASTER LED 8-50W+ 827 MR16 36D Dim

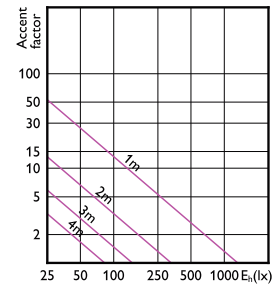

Accent Diagram - MASTER LED 6.5-50W 927 MR16 36D Dim

## Beam Diagrams

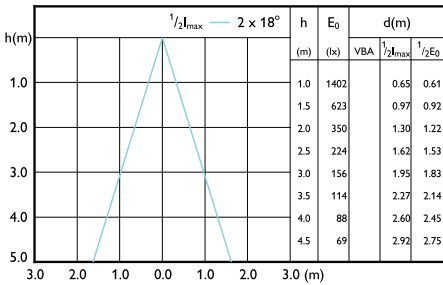

Beam diagram - MASTER LED 6.5-50W 940 MR16 36D Dim

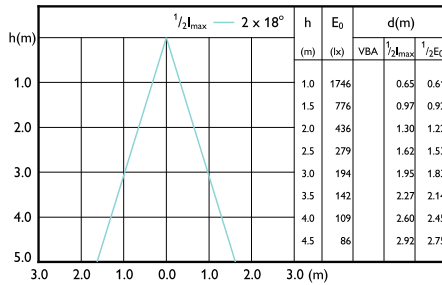

Beam diagram - MASTER LED 8-50W+ 827 MR16 36D Dim

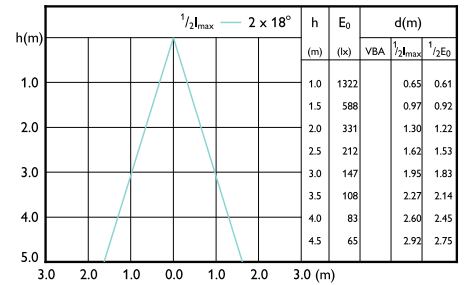

Beam diagram - MASTER LED 6.5-50W 927 MR16 36D Dim

